

UNIVERSITY OF CALIFORNIA

SANTA CRUZ

**NASALIZATION, NEUTRAL SEGMENTS,
AND OPACITY EFFECTS**

A dissertation submitted in partial satisfaction
of the requirements for the degree of

DOCTOR OF PHILOSOPHY

in

LINGUISTICS

by

Rachel Leah Walker

June 1998

The Dissertation of Rachel Leah Walker
is approved:

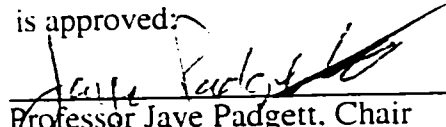

Professor Jaye Padgett, Chair

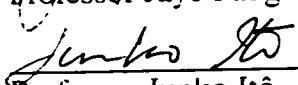

Professor Junko Itô



Professor Armin Mester

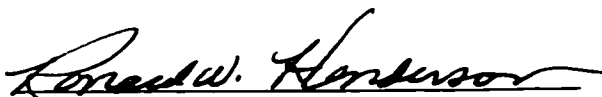

Dean of Graduate Studies

Copyright © by
Rachel Leah Walker
1998

Table of Contents

NASALIZATION, NEUTRAL SEGMENTS, AND OPACITY EFFECTS

Abstract		vii
Acknowledgements		ix
Chapter 1 Background		1
1.1 Introduction.....		1
1.2 Neutral segments and representations.....		7
1.3 Optimality Theory.....		12
1.3.1 Constraint ranking and violability.....		12
1.3.2 Constraints and Correspondence theory.....		16
1.3.3 Inputs and emergent contrast.....		20
1.4 Organization of the thesis.....		23
Chapter 2 A cross-linguistic typology of nasal harmony		25
2.1 Hierarchical variation in nasal harmony.....		28
2.2 Analysis of the typology.....		41
2.2.1 The constraints.....		41
2.2.2 A factorial ranking typology.....		56
2.2.3 The status of 'transparent' glottals.....		61
2.3 Interaction of the hierarchy with multiple constraints.....		64
2.4 Appendix: The nasal harmony database.....		69

2.4.1	Summary and discussion.....	69
2.4.2	The nasal harmony database (condensed version).....	85
Chapter 3	Segmental transparency as an opacity effect.....	99
3.1	Antagonistic transparency.....	101
3.2	Opacity in Tiberian Hebrew.....	111
3.3	Tuyuca.....	124
3.3.1	Phonetic versus phonological possibility.....	124
3.3.2	Harmonic sympathy in Tuyuca.....	129
3.3.3	Underlying representations and contrast.....	135
3.3.4	Cross-morphemic spreading and fixed affixes.....	145
3.3.5	Another abstract alternative.....	173
3.4	Some points of comparison between harmonic and constraint-based sympathy.....	177
3.5	Finnish.....	190
3.6	An evaluation metric for opacity.....	194
3.7	Appendix: German and harmonic sympathy revisited.....	199
Chapter 4	A phonetic study of Guaraní.....	226
4.1	Nasal harmony in Guaraní.....	227
4.2	Set-up.....	235
4.2.1	Data and data collection.....	235
4.2.2	Instrumental analysis.....	237
4.3	Results.....	240
4.3.1	General patterns.....	240
4.3.2	Effect 1: Ratio of closure duration to voice onset time....	243

4.3.3	Effect 2: Ratio of closure duration to closure voicing duration.....	250
4.3.4	A fixed property: Total period of voicelessness.....	254
4.4	Discussion.....	256
4.5	Two-burst events.....	265
4.6	Appendix: Word pairs.....	270
Chapter 5	Other proposals.....	272
5.1	A gapping alternative.....	273
5.2	The variable dependency hypothesis.....	277
5.3	Other approaches to segmental transparency.....	283
Chapter 6	Other phenomena: Reduplication and cooccurrence restrictions.....	288
6.1	Reduplication in Mbe.....	288
6.1.1	Nasal agreement in diminutive nouns.....	290
6.1.2	Nasal copy in imperative verbs.....	294
6.1.3	Back to diminutives: Another pattern predicted by ALLσL.....	304
6.1.4	Nasal agreement in inchoative verbs.....	316
6.1.5	Independent evidence for REALIZEMORPH: Zoque.....	319
6.1.6	Extending explanation to other affixation.....	324
6.1.7	Atemplatic versus templatic approaches to size restriction.....	328
6.1.8	Ruling out prespecification in reduplication.....	331

6.1.9	Appendix: Deriving CodaCond in Mbe.....	335
6.2	Cooccurrence effects in Bantu.....	349
	References.....	356

Abstract

NASALIZATION, NEUTRAL SEGMENTS, AND OPACITY EFFECTS

Rachel Leah Walker

June 1998

Directed by Professor Jaye Padgett

This thesis explores cross-linguistic variation in nasal harmony. The goal is to unify our understanding of nasal harmony so that patterns across languages conform to one basic character and to examine the wider implications of this account for phonological theory.

The analysis builds on generalizations from a comprehensive survey documenting variation in three descriptive sets of segments in nasal harmony: *targets*, which become nasalized, *blockers*, which remain oral and block spreading, and *transparent segments*, which remain oral but do not block. The typological generalizations established by this study provide strong support for a unified view of nasal harmony in which variation is limited in a hierarchical fashion.

To capture cross-linguistic variation, this analysis draws on a phonetically-grounded constraint hierarchy ranking segments according to their incompatibility with nasalization (building on Schourup 1972, Pulleyblank 1989; Piggott 1992; Cohn 1993c; Padgett 1995c; Walker 1995). Constraint ranking and violability, fundamental concepts in Optimality Theory (Prince and Smolensky 1993), also play a crucial role. Ranking a [nasal] spreading constraint at all points in relation to the hierarchy of violable nasalization constraints achieves precisely the attested set of patterns.

Another typological discovery is that transparent segments pattern with targets and should be regarded as belonging to this set of segments. A theoretical consequence is that [nasal] spreading never skips a segment, finding new support for strict segmental locality

(Ní Chiosáin and Padgett 1997: cf. Gafos 1996). The resulting challenge is determining what produces surface-transparent outcomes. Building on early derivational approaches (Clements 1976; Vago 1976), I propose to analyze segmental transparency as a derivational opacity effect. Following McCarthy (1997) and extensions by Itô and Mester (1997a), I achieve derivational opacity effects in Optimality Theory through a correspondence relation between the actual output and a designated 'sympathetic' (failed) member of the candidate output set. Sympathetic correspondence realizes transparency by selecting the output most closely resembling the nasal character of the fully-spread sympathetic form, while respecting nasal incompatibility constraints for segments that behave transparent. Importantly, by bringing segmental transparency under the wing of derivational opacity, transparency-specific representations can be eliminated from the theory.

Acknowledgements

There are a great number of people to whom I am grateful, and it is impossible to name them all here. The following is just a partial list.

First, I extend my deep gratitude to Jaye Padgett, who put a tremendous amount of energy into advising me on this dissertation. His continual advice, encouragement, and patience was fundamental in sustaining me through this process. I would also like to thank the other members of my committee, Junko Itô and Armin Mester, for their extensive comments on this work and supportive suggestions. The participation of each of my committee members has led to great improvements in this dissertation.

I feel as if I have an extended committee in four other professors who gave me detailed feedback on aspects of this work. This dissertation has benefitted from challenging discussions with Geoff Pullum. During my semester at UMass I received many suggestions and comments from John McCarthy, Diamandis Gafos, and John Kingston. I would like to thank John McCarthy for sponsoring my visit to UMass and for inviting me to participate in his NSF grant phonology meetings. I am grateful to John Kingston for advice on my Guaraní project from start to finish.

Special mention goes to Will Leben for his participation in my thesis prospectus defense, to John Ohala for his help with the analysis of the Guaraní data, and to Sharon Inkelas for stimulating discussions when I first started thinking about nasal harmony. I would also like to thank all of the linguistics faculty at UCSC: they have each contributed to my understanding of what it means to be a good researcher and a good teacher.

My friends and colleagues at UCSC have played an important role in my making it successfully through graduate school. Jason Merchant has been a true friend and a great classmate. Motoko Katayama and Chris Kennedy have also been great friends and offered tremendous support in making it through the dissertation year. For contributing to the

friendly phonology community at Santa Cruz thanks to Dan Karvonen, Kazutaka Kurisu, Jaime Rodriguez, Nathan Sanders, Adam Sherman, and Philip Spaelti. I am grateful to Chris Gunlogson and Kari Swingle for being great listeners, and for setting a good example, thanks to Ted Fernald, Michael Johnston, Eric Potsdam, and Peter Svenonius.

I would also like to express my gratitude to people at other institutions. At UMass I benefitted greatly from conversations with John Alderete and Brett Baker; also Jose Benki, Katy Carlson, Caroline Jones, Andre Isaak, Kiyomi Kusumoto, Anna Lubowicz, Elliott Moreton, Marc van Oosterdorp, and Jennifer Smith. Thanks to Bart Hollebrandse and Winnie Lechner for their friendship. For useful discussions I am grateful to Eric Bakovic, Jill Beckman, Andy Dolbey, Larry Hyman, Orhan Orgun, Joe Pater, Alan Prince, Sharon Rose, Ron Sprouse, Su Urbanczyk, Moira Yip, and Cheryl Zoll.

Thanks are also due to friends and teachers at the University of Toronto, where I started my career in linguistics. I am particularly grateful to Keren Rice, who has been a continual support, advisor, and friend; also Liz Cowper, Elan Dresher, Hank Rogers, Peter Avery, and Tom Wilson. Andrew Carnie, who I have known since that first introductory class in linguistics, has been a great friend through the years.

Various aspects of the dissertation research have been presented at the following conferences: ESCOL at the University of South Carolina (1994), WECOL at UCLA (1995), NWLC at the University of Washington (1996), AFLA at UCLA (1996), TREND at Stanford University (1996), the annual meeting of the LSA in New York (1998), WCCFL at the University of British Columbia (1998), and the Phonetics-Phonology Mini-Symposium at UC Berkeley. I am grateful to audience members at all of these meetings for their questions and comments. This research was supported by a doctoral fellowship 752-93-2397 from the Social Sciences and Humanities Research Council of Canada and NSF grant SBR-95-10868 to Junko Itô and Armin Mester, and it benefitted from ideas discussed in meetings for NSF grant SBR-94-20424 to John McCarthy.

For all the support they have given me over the years, thanks to my family. Mom and Richard, Dad and Laurie, and Rebecca and Aaron. Grandma and Grandpa Hamill were truly an inspiration. Finally, to my husband Geoff, thank you for the endless patience, love, and support you have given me: this is for you.

Chapter 1

BACKGROUND

1.1 Introduction

It has long been known that the feature [nasal], which corresponds to the property of having a lowered velum during a segment, can come out as the property of not just one segment but a string of segments in the words of some languages. Descriptively speaking, this comes about when an underlyingly nasal segment, such as a phonemic nasal stop or nasal vowel, triggers the nasalization of an adjacent string of segments in a predictable and phonologized way. This is the phenomenon known as nasal feature spreading or ‘nasal harmony’, which will be examined here. The aims of this work are two-fold. The goal is first to unify our understanding of nasal harmony so that patterns across languages conform to one basic character, something that has not been achieved before. The second goal is to examine the wider implications of this account for phonological theory. The theoretical findings are sketched in (1) with amplification below.

(1) Sketch of theoretical findings:

- i. Patterns of nasal harmony across languages can be unified into one basic type.
- ii. Cross-linguistic variation in nasal harmony is governed by a phonetically-grounded constraint hierarchy ranking segments according to their compatibility with nasalization (building on insights of previous studies: Schourup 1972; Pulleyblank 1989; Piggott 1992; Cohn 1993a, c; Padgett 1995c; Walker 1995; cf. also Hume and Odden 1994).

- iii. Constraint ranking and violability. fundamental concepts in Optimality Theory (Prince and Smolensky 1993), are crucial to obtaining a unified understanding of nasal harmony. Cross-linguistic variation is achieved by ranking the spreading constraint at all points in relation to the nasalization hierarchy. The unified typology is obtained by positing all nasalization constraints as violable.
- iv. Descriptively transparent segments should be understood as belonging to the set of target segments, i.e. segments which undergo nasal spreading. A theoretical consequence is that [nasal] spreading (and all feature spreading) takes place only between adjacent segments, finding new support for the concept of strict segmental locality in feature spreading (after a proposal of Ní Chiosáin and Padgett 1997; cf. Gafos 1996; foundational analyses appear in Ní Chiosáin and Padgett 1993; McCarthy 1994; Flemming 1995b; Padgett 1995a; for related ideas see Allen 1951; Stampe 1979).
- v. Building on previous derivationally-opaque rule-ordered accounts of segmental transparency (e.g. Clements 1976; Vago 1976), true surface transparency can be obtained through opaque constraint interaction (McCarthy 1997; Itô and Mester 1997a, b), a mechanism with independent motivation in phonological theory. This obviates the need for calling on the 'gapped configuration', an ad hoc device specific to segmental transparency.

The account developed here is built on a solid empirical basis: the claim that there is just one basic kind of nasal harmony is motivated by generalizations established by a comprehensive cross-linguistic survey encompassing the nasal harmony patterns of over 75 languages. From a theoretical perspective, there are several important issues illuminated by this work. These are outlined above and are explained in more detail in what follows.

One important aspect of this account is that it draws on a phonetic basis for the formal analysis of limitations on cross-linguistic variation. This is expressed in the form of a phonetically-grounded constraint hierarchy ranking segments according to their (in)compatibility with nasalization. The concept of a hierarchical (in)compatibility of nasalization can be traced back to Schourup (1972) and gains subsequent foundation from the work of Pulleyblank (1989); Piggott (1992); Cohn (1993a, c); Padgett 1995c, and Walker (1995) (Hume and Odden 1994 propose a different yet related hierarchy based on impedance). The proposed fixed ranking of the nasalization constraints in relation to one another derives the implications (observed in the present study and by researchers cited above) that if a segment blocks nasal spreading, all less compatible segments will also block and if a segment is targeted by nasal spreading, all more compatible segments will also be targeted. Most phonological theories agree that phonology has at least some basis in phonetic universals, and recently there has been an increased emphasis — in works too numerous to list — on seeking the ‘phonetic grounding’ for phonological generalizations (‘phonetic grounding’ after Archangeli and Pulleyblank 1994). As Cohn (1993a) points out, the (in)compatibility of segments with nasalization is judged on the basis of both articulatory/aerodynamic and acoustic/perceptual factors. For example, vowels are relatively compatible with nasalization from both phonetic perspectives: a lowered velum does not interfere with the production of a vowel, and both nasality and vowel quality are relatively well-perceived together in comparison to other nasalized continuants (although nasalization is well-known to have effects on perception of vowel quality; see, for example,

Wright 1986; Padgett 1997; with foundation from Ruhlen 1975; Beddor 1983). In contrast, fricatives are poor on compatibility with nasalization. A nasalized fricative is problematic aerodynamically, because the lowered velum conflicts with the build-up of air pressure behind the constriction needed to produce turbulent airflow (J. Ohala 1975; Ohala and Ohala 1993; Ohala, Solé, and Ying 1998). It thus is difficult to produce audible frication and simultaneous audible nasalization. These phonetic considerations yield a relatively low placement for vowels in a scale of incompatibility with nasalization and a relatively high ranking for fricatives, corresponding to their patterning across languages.

A central finding of this work is that certain key theoretical assumptions in Optimality Theory (Prince and Smolensky 1993) are fundamental to achieving a unified understanding of different systems of nasal harmony. These crucial elements are the notions of constraint ranking and constraint violability. An optimality-theoretic grammar contains a language-particular hierarchy of universal constraints which simultaneously evaluate a set of possible output candidates. The candidate which is most harmonic with respect to the constraint hierarchy is the one which wins. Prince and Smolensky (1993: 84) note that language typologies will be derived by factorial constraint ranking, i.e. cross-linguistic variation is obtained by different rankings of the set of universal constraints, and the set of possible languages will be given by the set of possible rankings (factoring out fixed rankings, such as the nasalization constraint hierarchy). In the case of nasal harmony, I show that ranking of the constraint driving nasal spreading at all of the possible points in relation to the nasalization hierarchy achieves precisely the cross-linguistic variation which is attested. Importantly, the unified typology is obtained by positing *all* of the nasalization constraints as violable.

A focal discovery emerging from the descriptive typological generalizations is that transparent segments (i.e. segments that remain oral but do not block nasal spreading) pattern with the set of targets (segments that undergo nasalization in nasal spreading) and

should be regarded as belonging to this set of segments. The evidence for this claim is two-pronged. One point concerns a complementarity between systems with blocking segments (i.e. segments that remain oral and block nasal spreading) and those with transparent segments, identifying a complementary relationship between the sets of possible targets and transparent segments. It is observed first that all segments have the potential to block nasal spreading: yet all segments *except some obstruents* have the potential to undergo nasal harmony and *only obstruents* ever behave transparent. Positing descriptively transparent segments as undergoers of nasal harmony addresses this otherwise unexplained complementarity. The second point stems from the observation that transparent segments exhibit the same hierarchical implications as targets: if a segment behaves transparent, all more compatible segments will undergo nasal spreading. This co-patterning is explained under the analysis of transparent segments as targets. A consequence of this move is that segments behave in only one of two ways in nasal harmony, they either undergo [nasal] spreading or they block, so spreading never skips an intervening segment. This account thus offers new evidence for the strict segmental locality of feature spreading, that is, restricting feature spreading to taking place between strictly adjacent segments (after Ní Chiosáin and Padgett 1997: cf. Gafos 1996: foundational work includes Ní Chiosáin and Padgett 1993; McCarthy 1994; Flemming 1995b; Padgett 1995a; cf. also Allen 1951; Stampe 1979).

With descriptively-transparent segments in nasal harmony analyzed as targets of nasal spreading, a new question emerges: what produces the surface transparent outcome for these segments? An acoustic study of ‘transparent’ voiceless stops in Guaraní verifies that this is indeed a question: voiceless stops are truly oral in nasal harmony spans in the language. Following early derivational analyses for transparent segments in vowel harmony proposed by Clements (1976) and Vago (1976), I propose to analyze segmental transparency as an instance of a derivational opacity effect (‘opacity’ in the sense of

Kiparsky 1971, 1973), i.e. the kind of phonological outcome obtained in derivational frameworks through the opaque ordering of rules. This kind of approach to segmental transparency makes reference to a representation in which nasalization has spread to all target or transparent segments ($[\tilde{a}tata] \rightarrow [\tilde{a}\tilde{t}\tilde{a}\tilde{t}\tilde{a}]$) with subsequent rule application or mapping to a form with nasalization of all segments except obstruents ($[\tilde{a}\tilde{t}\tilde{a}\tilde{t}\tilde{a}] \rightarrow [\tilde{a}t\tilde{a}t\tilde{a}]$). In a derivational approach, the representation with full nasal spreading constitutes a form derived at an intermediate stage. In the optimality-theoretic account developed here, the fully-nasalized form will be a (failed) member of the output candidate set, designated the special status of ‘sympathy’ candidate, following the proposal of McCarthy (1997) with further developments by Itô and Mester (1997a, b). After McCarthy (1997), I call on a faith relation between the sympathy candidate and the actual output to produce (derivational) opacity effects. This faith mapping will select the candidate most closely resembling the nasal character of the fully-spread sympathy form, while respecting a constraint prohibiting nasalized obstruents. The actual output will then be a form with nasalization of all segments except surface-transparent obstruents. Importantly, at no point will it be necessary to make use of a form with a gapped configuration, i.e. one with linkage of a feature across a skipped transparent segment, a representation which has been utilized solely for the purpose of analyzing segmental transparency (see Pulleyblank 1996 for a similar argument against using the gapped configuration, but with a different analysis of segmental transparency; cf. also Archangeli and Pulleyblank 1994; both of these accounts do not assume strict segmental locality and allow targetting of higher level structure, such as moras in vowel harmony). The need for parochial representations with the gapped configuration is thus eliminated, and segmental transparency is brought into the fold of a widespread phonological phenomenon, namely derivational opacity effects.

1.2 Neutral segments and representations

In talking about nasal harmony it will be necessary to refer to different kinds of segmental behavior. I outline four descriptive categories of segments in (2) with the segment in question underlined (and nasalization marked with tildes). The first category is *trigger* segments: these are segments that initiate the spreading of nasality (2a). Second is the category of *target* segments, which become nasalized in nasal harmony (2b). Next is the category known as *blocking* or *opaque* segments: these segments remain oral and block the continuation of spreading (2c). Last is the category of *transparent* segments, which are those that remain oral themselves but allow spreading to continue (2d).

- (2)
- a. *Trigger segments:* Segments that initiate nasal spreading.
e.g. /na/ → [n̄ã].
 - b. *Target segments:* Segments that undergo nasal spreading.
e.g. /na/ → [nã].
 - c. *Blocking or opaque segments:* Segments that remain oral and block nasal spread. e.g. /nata/ → [nãta].
 - d. *Transparent segments:* Segments that remain oral but do not block nasal spreading. e.g. /nata/ → [nãtã].

It should be noted that these categories are for descriptive purposes only and do not necessarily correspond to the analytical distinctions that will be made. As previewed in the preceding section, it will be argued in a later chapter that the categories of target and transparent segments should be collapsed in some respects in the analysis.

The descriptive classes of segments that fail to become nasalized in nasal harmony, i.e. the blocking and transparent segments, together constitute the *neutral* segments. The canonical derivational autosegmental or feature-geometric approach to segmental neutrality calls on representations to distinguish these segments. The present work places less focus on assumptions about representations, but before previewing this, I will briefly review the representational-derivational approach. In the representationally-driven kind of account, explanation of blocking makes use of the standard autosegmental assumption of the No Crossing Constraint, which forbids line crossing (Goldsmith 1976).

(3) No Crossing Constraint

$$* \quad \begin{array}{cc} \alpha & \beta \\ \times & \\ F_1 & F_2 \end{array}$$

As various analysts have noted, the ill-formedness of line crossing can be understood in terms of contradictory precedence relations (see Sagey 1988; Hammond 1988; Scobbie 1991; Archangeli and Pulleyblank 1994). On the one hand, α precedes β on one tier, and F_1 precedes F_2 on another tier. However, since F_1 is linked to β and F_2 is linked to α , F_2 precedes F_1 . Thus F_1 precedes F_2 and F_2 precedes F_1 , giving a precedence contradiction.

Using the No Crossing Constraint, many representationally-based accounts achieve blocking of spreading through the presence of structure. In nasal harmony, this could consist of the presence of a [-nasal] specification on the blocking segment. This is illustrated in (4). In (4a) the [+nasal] feature spreads up to the segment specified as [-nasal]. Spreading across the [-nasal] segment is ruled out by No Crossing (+b).

(4) Representational approach to segmental blocking

a.	Input	→	Output
	$\begin{array}{cccc} \alpha & \beta & \gamma & \delta \\ & & & \\ [+N] & & [-N] & \end{array}$		$\begin{array}{cccc} \alpha & \beta & \gamma & \delta \\ \backslash & / & & \\ [+N] & & [-N] & \end{array}$
b.	Input	→	*Output
	$\begin{array}{cccc} \alpha & \beta & \gamma & \delta \\ & & & \\ [+N] & & [-N] & \end{array}$		$\begin{array}{cccc} \alpha & \beta & \gamma & \delta \\ \backslash & & \times & \\ [+N] & & [-N] & \end{array}$

For segmental transparency, representational accounts make use of a configuration in which spreading takes place across an intervening segment. In some accounts, this may occur by simply skipping the target node, yielding a gapped configuration across the transparent segment (γ), as in (5a). Feature-geometric approaches avoid gapping across a target node by positing a more elaborated segment structure in which the spreading feature is dependent on an organizing tier (for example, a supralaryngeal tier). With this model, the skipping effect comes about by virtue of the absence of structure, i.e. when a segment lacks the target node for feature spreading in its representation. The standard assumption of locality in a feature geometric framework is that node adjacency is evaluated on its own tier, so locality is not violated in linking across an intervening segment provided that no target nodes themselves are skipped. An example of this kind of segmental skipping (of γ) is shown in (5b). This kind of approach for nasal harmony is employed by Piggott (1992), and it has been widely utilized in other feature-geometric accounts of transparency of various kinds.

(5) Segmental transparency by gapping/skipping

	a.	Input	→	Output
		$\alpha \ \beta \ \gamma \ \delta$ $\quad $ $[+N]$		$\alpha \ \beta \ \gamma \ \delta$ (gapping) $\quad \backslash \ \backslash \ /$ $\quad \quad [+N]$
	b.	Input	→	Output
root		$\alpha \ \beta \ \gamma \ \delta$ $\quad \ \ $		$\alpha \ \beta \ \gamma \ \delta$ (segment skipping) $\quad \ \ $
organizing tier		$\quad \bullet \ \bullet \ \bullet$		$\quad \bullet \ \bullet \ \bullet$
nasal tier		$\quad $ $[+N]$		$\quad \backslash \ \backslash \ /$ $\quad \quad [+N]$

The need for calling on segmental skipping configurations in feature linking to obtain transparency effects has been called into question (Ní Chiosáin and Padgett 1997; cf. also Gafos 1996; for foundational analyses see Ní Chiosáin and Padgett 1993; McCarthy 1994; Flemming 1995; Padgett 1995a; more generally on disallowing gapping across targets see Kiparsky 1981; Levergood 1984; Archangeli and Pulleyblank 1994; Pulleyblank 1996). The ill-formedness of spreading across intervening segments is a formal theoretical issue which will be discussed in chapter 2. In addition to the formal dimension there is the question of motivation and explanatory adequacy. On the subject of motivation, it is matter of concern that this kind of skipping representation is utilized solely to obtain segmental transparency. Even with this neutrality-specific device, there are problems in the explanation provided. Given the representational assumptions concerning segmental blocking and transparency, no single feature-geometric structure can produce the blocking behavior of obstruents in some languages and their transparent behavior in others. This dilemma leads Piggott (1992), to propose that there are two kinds of nasal harmony which differ in the dependency of the feature [nasal] in the geometry: in harmony with a set of

blocking consonants, [nasal] appears under a certain organizing node in (some) consonants, while in patterns with transparent obstruents, [nasal] is dependent on another organizing node present only in sonorants. While it offers the best available analysis under feature-geometric assumptions of segmental neutrality, the variable dependency account is unsatisfying in that it fails to find a commonality across all nasal harmony patterns. This is a result driven in part by the assumption that spreading takes place by skipping over transparent segments, which lack target structure.

The optimality-theoretic account that I propose turns away from using the device of segmental skipping in spreading to obtain transparency: in fact, it is the assumption of this kind of representation that has led us astray from perceiving a unified understanding of nasal harmony patterns, whether they exhibit examples of segmental blocking or transparency. The autosegmental representations I assume are minimal, consisting of features linked directly to root nodes. Generalizations concerning feature class behavior have been explained independent of feature organizing structure in Optimality Theory under Feature Class Theory, developed by Padgett (1995a). I put forth a typological argument that transparent segments should be regarded as undergoers of feature spreading, giving just two kinds of outcomes for segments with respect to spreading: they can be targets or blockers. Segmental transparency is analyzed as the result of the independently-motivated theoretical mechanism which obtains (derivational) opacity effects. To obtain blocking effects I do not assume input specification of [-nasal] on blocking segments, rather I call on optimality-theoretic, output-oriented feature cooccurrence constraints prohibiting the combination of [+nasal] with different segmental classes (with basis in the proposals of Kiparsky 1985; Pulleyblank 1989; Archangeli and Pulleyblank 1994). Analyzing blocking in this way has two important benefits. First, because the feature cooccurrence constraints are ranked, it provides a formal means of incorporating the hierarchical cross-linguistic variation in sets of blockers and targets across languages. Arraying the nasalization

constraints according to phonetic compatibility gives a fixed nasalization constraint hierarchy, and then hierarchical variation comes out as differences in where languages make the cut between segments that are compatible enough with nasalization to undergo nasal spreading and those that are not. Second, positing nasal feature cooccurrence constraints as violable (in an optimality-theoretic model) rather than necessarily respected in the output of languages, yields not only the cross-linguistic variation, but it is also crucial to obtaining a unified account of nasal harmony. An insight of this study is that transparent segments pattern with targets: in order to achieve this, transparent segments must also be able to undergo nasal spreading, requiring a notion of all nasalization constraints as potentially violable in outputs. By turning the analytical focus away from representational explanation and towards outcomes of hierarchies of ranked and violable constraints, the account brings new insight to the understanding of the typology of nasal harmony.

1.3 Optimality theory

1.3.1 Constraint ranking and violability

The theoretical framework that I assume here is that of Optimality Theory (OT; Prince and Smolensky 1993). This approach departs from generative frameworks in which a sequence of rules are applied to an input to carry it through various intermediate forms to a surface output. Optimality Theory instead conceives of grammars as a hierarchy of ranked and violable universal constraints which evaluate the well-formedness of output forms. Parallel evaluation of a set of candidate output forms selects the actual output by virtue of it being the most harmonic or *optimal* with respect to the constraint hierarchy. The goal of constraint ranking is thus to select all and only those outputs which are well-formed in the language.

In an optimality-theoretic grammar there are three components: *Gen*, *Con*, and *Eval* (Prince and Smolensky 1993). *Gen* is a function which generates the range of candidate

outputs for an input i . Gen includes the primitives of phonological structure and contains information about the inviolable elements of their organization. In generating the infinite set of candidate outputs for a given input, it is constrained by these inviolable primitives but otherwise posits strings and structures freely, which may or may not resemble the input form. Con is the set of universal constraints out of which grammars are constructed. The constraints belonging to Con are those that may be violated in the candidate outputs of a language. While the members of Con remain fixed across languages, language-particular orderings are imposed on the constraints; this ranking is the language-particular component of the grammar Γ . Selection of the optimal candidate from the infinite candidate set falls to Eval. Eval is a function that comparatively evaluates the set of output candidates with respect to a given constraint hierarchy, the ranking of Con that constitutes the Γ . The structure of an optimality-theoretic grammar is outlined in (6). The function Gen operates on an input to yield an (infinite) set of candidate outputs. Eval then evaluates this set of candidate outputs in relation to Γ to select the optimal output, the actual output form for the input.

(6) Schema for an optimality-based grammar:

- a. Gen (input _{i}) → { cand₁, cand₂, ... }
- b. Eval (Γ , {cand₁, cand₂, ...}) → { cand_{real} }

The optimality-theoretic evaluation of an output form is illustrated with a concrete example in (7). Evaluation is displayed in a tableau which arrays the input and candidate outputs at the left, and the hierarchy of constraints heads successive columns with ranking descending from left to right. By convention, crucial constraint ranking is marked by solid

lines separating constraint columns; if ranking of two constraints is undetermined, they are separated by a dotted line or no line at all. Rows tabulate the violations incurred by each candidate with respect to the hierarchy of constraints. The input here is /nar/, and Gen operates on this to give a set of candidates to evaluate as possible outputs for this input. Three of the more competitive candidates are shown here. The evaluation of these candidates is performed in relation to the hierarchy of constraints of which I have shown a segment here, with a markedness constraint forbidding nasalized liquids (*NASLIQUID, abbreviating a feature cooccurrence constraint) ranked over a constraint requiring that the feature [+nasal] spread to all segments in the word (SPREAD[+nasal]). Evaluation is performed from left to right. First examining the column for *NASLIQUID, it is apparent that candidate (c) incurs a violation (marked by '**'). This violation is fatal for this candidate, since there are competitors which do not violate this constraint. The fatality is signalled by the exclamation mark and succeeding columns for this candidate are shaded. Moving on to the SPREAD[+nasal] constraint column, candidate (a) better satisfies the spreading constraint than (b), because (a) has failed to spread to only one segment, while (b) has failed to spread to two. This is a case of gradient constraint violation, where violations are computed incrementally on some basis (a formal expression of the spreading constraint and computation of its violations is discussed in chapter 2). Candidate (a), with spreading of [+nasal] to the vowel but not the liquid, is thus the winner of this candidate set, as signalled by the right-pointing hand.

(7) Constraint tableau: *NASLIQUID >> SPREAD[+nasal]

Input /nar/	*NASLIQUID	SPREAD[+nasal]
a. nār (cand ₁)		*
b. nar (cand ₂)		**!
c. nār (cand ₃)	*!	

An important feature of OT illustrated by the above example is that constraints are ranked and violable. Constraints are ranked in a *strict dominance hierarchy* such that each constraint has absolute priority over any constraint that it dominates (i.e. that is ranked lower) (Prince and Smolensky 1993: 2). In this way, ranking expresses the precedence of one constraint over the other and satisfaction of a higher-ranked constraint can drive the violation of a lower-ranked one. As a result, the optimal output may actually violate many constraints. Constraints thus do not represent surface-true generalizations for the language, rather they express phonological demands which are ranked in their requirement for satisfaction. The demands expressed by constraints will be satisfied whenever possible, and they will be violated in an output only when compelled by higher-ranked and conflicting constraint demands.

As noted above, the universal constraints of Con are ranked on a language-particular basis. Variation across languages comes about as a consequence of permuting the rankings of constraints, and the set of possible grammars is given by the set of all of the possible rankings. Assuming that all rankings are possible, n constraints will give $n!$ possible grammars, this is the notion of language typology as *factorial typology* discussed by Prince and Smolensky (1993: 84). Importantly, factorial ranking of constraints may be modulated by fixed rankings of sets of related constraints given by phonetic or *harmonic* scales (Prince and Smolensky 1993). These fixed rankings will be factored out from the possible permutations. A well-known example of this kind is the syllable peak and margin

scales arraying segments according to their sonority (Prince and Smolensky 1993). A case to be discussed in this work is a nasalization scale ranking segments according to their compatibility with nasality.

1.3.2 Constraints and Correspondence theory

The constraints of Con fall into two main categories: *markedness constraints* and *faithfulness constraints*. Markedness constraints are all of those that evaluate the well-formedness of elements of the phonological structure (e.g. constraints on prosodic structure, feature cooccurrence, the OCP, nonfinality, alignment, spreading, etc.). Feature cooccurrence constraints, such as *NASLIQUID (i.e. *[+nasal, +approximant, +consonantal]), are a kind of markedness constraint that will play an important role in the analysis. I assume that for every feature combination there is a cooccurrence constraint, although this is not crucial to the analysis. Some segments will obviously be more harmonic on phonetic grounds than others, for example, nasal sonorant stops, such as [n] are preferred to nasalized fricatives. This phonetic grounding underlies the tendency for constraints against nasal stops to be low-ranked across languages, explaining their occurrence in almost all every language.

Another important kind of markedness constraint is the family of alignment constraints, which require the nearest possible coincidence of edges of phonological and/or grammatical constituents (McCarthy and Prince 1993b). A general schema for alignment constraints is given in (8) (after McCarthy and Prince 1993b: 2).

(8) Alignment constraint schema

$$\text{ALIGN}(\text{Cat}_1, \text{Edge}_1, \text{Cat}_2, \text{Edge}_2) =_{\text{def}}$$

$$\forall \text{Cat}_1 \exists \text{Cat}_2 \text{ such that Edge}_1 \text{ of Cat}_1 \text{ and Edge}_2 \text{ of Cat}_2 \text{ coincide.}$$

Where

$$\text{Cat}_1, \text{Cat}_2 \in \text{PCat} \cup \text{GCat}$$

$$\text{Edge}_1, \text{Edge}_2 \in \{\text{right, left}\}$$

Constraints in the alignment category have been utilized in the optimality-theoretic analysis of a wide range of phenomena, especially in the area of prosodic morphology, an application that will be illustrated by their pivotal function in the analysis of Mbe discussed in chapter 6. In addition, building on a proposal of Kirchner (1993) alignment constraints have been used by many analysts to drive feature spreading (e.g. Pulleyblank 1993, 1996; Smolensky 1993; Akinlabi 1996, to appear; Itô and Mester 1994; Cole and Kisseberth 1994, 1995; Walker 1995; Beckman 1998; cf. also Ringen and Vago 1997). Following the work of Padgett (1995b) on nasal place assimilation, the nasal feature spreading constraint in this account (discussed in chapter 2) is not formulated strictly in terms of alignment, in order to emphasize the non-directional nature of nasal spreading in languages like Tuyuca; however, this distinction is not a crucial one in the analysis.

The second main constraint category is that of faithfulness constraints. Following McCarthy and Prince (1995), I adopt the Correspondence view of faithfulness. Faithfulness constraints in correspondence theory demand identity of structure and content in the input and output, or in the case of reduplication, between the base and reduplicant (reduplication will become relevant in the analysis of Mbe in chapter 6). An illustration of the systems of faithfulness relations holding in a form with a reduplicative affix is given in (9). This is the Basic Model of McCarthy and Prince (1995)

(9) The Basic Model

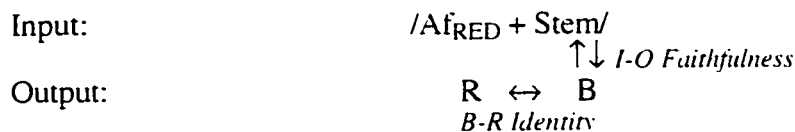

Input-output faithfulness (Faith-IO) evaluates faith between input and output, and base-RED faithfulness (Faith-BR) evaluates faith between a base and reduplicant. Focusing on the correspondence of strings, McCarthy and Prince (1995: 262) define correspondence as in (10) where S_1 refers to an element such as an input or base and S_2 refers to the output or reduplicant.

(10) Correspondence

Given two strings S_1 and S_2 , correspondence is a relation R from the elements of S_1 to those of S_2 . Elements $\alpha \in S_1$ and $\beta \in S_2$ are referred to as correspondents of one another when $\alpha R \beta$.

Gen may freely posit correspondence relations or the lack thereof, and these relations are evaluated by constraints on correspondent elements with only complete identity and correspondence between input and output fully satisfying the array of faithfulness constraints. Three kinds of correspondence constraints on segments will be outlined here with others detailed in the text of later chapters as they become relevant.

Three families of correspondence constraints on segments are given in (11), following the formulation of McCarthy and Prince (1995: 264). The MAX family of constraints expresses the requirement that segments not be deleted (11a). MAX-IO demands this of an output in relation to an input, and MAX-BR demands this for a reduplicant in relation to a base. The DEP family of constraints acts against the insertion of

elements in an output or reduplicant which are not in correspondence with segments in the input or base (11b). IDENT constraints refer to the featural content of segments, requiring that correspondent segments be featurally identical to each other (11c). Importantly, IDENT constraints demand identity of featural properties of correspondent segments and do not evaluate correspondence between features themselves.¹ This characterization of featural faith will prove to be crucial in the analysis of segmental transparency as a (derivational) opacity effect. Following Pater (in press) and McCarthy and Prince (1995), I assume that IDENT constraints can be differentiated into [+F] and [-F] versions for the same feature.

- (11) a. MAX
Every segment of S_1 has a correspondent in S_2 . (No deletion of segments.)
- b. DEP
Every segment of S_2 has a correspondent in S_1 . (No insertion of segments.)
- c. IDENT[F]
Let α be a segment in S_1 and β be any correspondent of α in S_2 . If α is [+F], then β is [+F]. (Correspondent segments are identical in feature F.)

The above outlines the basics of Correspondence theory. In chapter 3, another correspondence relation will be added, one holding between a 'sympathy' candidate and the actual output (after McCarthy 1997). This will be discussed in the text when it becomes relevant.

¹ While an IDENT conception of featural faith can handle many kinds of featural phenomena and indeed is crucial for some, there are some cases where a correspondence view of features seems to be required. For discussion, see McCarthy and Prince (1995); Lombardi (1995a, 1998); Causley (1996); Walker (1997b); Yip (to appear) (cf. also Lamontagne and Rice 1995).

1.3.3 Inputs and emergent contrast

On the subject of inputs, I assume the principle of 'Richness of the Base' (Prince and Smolensky 1993: 191), which hypothesizes that all inputs are possible. The constraints in Con evaluate outputs only (including their faithfulness to the input), and they do not hold of inputs. This gives us a universal set of inputs for all languages. The role of the constraint hierarchy component of the grammar is then to select only those outputs which conform to the phonological generalizations of the language. As a consequence, it is necessary for the analyst to ensure that the constraint rankings proposed for a given language will produce a grammatical outcome for any possible input, even if that input contains structures that never surface in the language.

In OT, a distinction may be drawn between inputs and underlying representations. Input forms belong to the universal set for all languages, and this is the set for which it is the task of the constraint hierarchy of the language to produce only grammatical outcomes. Because more possible inputs exist than actual outputs, there will be a many-to-one mapping from inputs to outputs. On the other hand, for a given output of an actual form in the language, it has been proposed that the learner posits a single underlying representation: this is not just a possible input but one which corresponds to the actual input posited for that lexical item (Prince and Smolensky 1993). In OT, selection of the underlying representation from the set of possible inputs for an output form follows the principle of Lexicon Optimization (Prince and Smolensky 1993: 192; Itô, Mester and Padgett 1995: 593; see also Inkelas 1994). Lexicon Optimization selects as the real input (i.e. the underlying representation), the one of all the potential inputs that is most harmonic with respect to the constraint hierarchy for the language. Thus, of all the possible inputs that map to a particular output, the one that will be selected as the optimal input or underlying form is the one that most closely resembles the output form.

With the principle of Richness of the Base and constraints holding of outputs not inputs, segmental inventories and contrasts are not properties assumed to hold of inputs, rather they must be derived by the interaction of constraints in the hierarchy. I follow Prince and Smolensky (1993) in assuming that inventories and contrast are emergent properties of the ranking of faith and markedness constraints.² I illustrate with an example of a language exhibiting a distribution in which vowels are phonemically only oral, but are contextually nasalized following a nasal stop. This follows the details of the analysis of Madurese proposed by McCarthy and Prince (1995).

In the general case, nasal vowels are prohibited in the language. This may be obtained in the outputs of the language by ranking a constraint against nasal vowels (*NASVOWEL) over a constraint requiring identity for [nasal] (IDENT-IO[±nasal]). Thus, if an input were to contain a nasal vowel (a possibility given by Richness of the Base), it would map to an output containing an oral vowel. This is illustrated in (12).

(12) *NASVOWEL >> IDENT-IO[±nasal]

	/dã/	*NASVOWEL	IDENT-IO[±nasal]
☞	a. da		*
	b. dã	*!	

Note that another input /da/ would also map to the same output. By Lexicon Optimization, /da/ would be selected as the underlying representation, because it is more harmonic with respect to the constraint hierarchy. This is shown by the 'tableau des tableaux' (after Itô, Mester, and Padgett 1995) in (13) which compares the harmonicity of

² Note that this assumption concerning contrast is not necessarily a crucial one to the analysis. Flemming (1995a) develops an optimality-theoretic approach called Dispersion Theory (extending ideas of Lindblom 1986, 1990; see Steriade 1995b for related ideas; also Padgett 1997). The Dispersion Theory approach offers some valuable explanation and may well be a preferable alternative, but this is a matter beyond the scope of the present study.

the two possible inputs for the same output. Nasalized vowels will thus not occur in the general case in the underlying representations of the language.

(13) Lexicon Optimization: selecting the underlying representation

Input	Output	*NASVOWEL	IDENT-IO[±nasal]
a. da	da		
b. dā	da		*!

In the environment of a nasal consonant, nasal vowels do occur; in fact they must be nasalized in this context. This may be driven by a general nasal spreading constraint, which I will express as SPREAD[+nasal], requiring that the feature [+nasal] spread to all segments when it occurs in the output of a word. To enforce the occurrence of a nasal vowel in the output, SPREAD[+nasal] must outrank *NASVOWEL. The outcome for a nasal + oral vowel input is shown in (14): the vowel is nasalized in the output. This is an example where faith and markedness interact to produce allophony.

(14) SPREAD[+nasal] >> *NASVOWEL

/na/	SPREAD[+nasal]	*NASVOWEL	IDENT-IO[±nasal]
a. nā		*	*
b. na	*!		

Another input that will map to the same output as in (14) is the one with nasalization of the vowel /nā/. Since this form is closer to the actual output than /na/, Lexicon Optimization will select the form with the nasalized vowel as underlying in this case:

(15) Lexicon Optimization

	Input	Output	SPREAD[+nas]	*NASVOWEL	IDENT-IO[±nasal]
☞	a. nã	☞ nã		*	
	b. na	☞ nã		*	*!

Nasalized vowels are thus not excluded from underlying representations, in fact they are posited in underlying representations in this language precisely where they occur with an allophonic distribution in the output: oral vowels will occur in underlying representations in the ‘elsewhere’ environment. As a consequence, the distinction between phonemic versus allophonic distributions does not correspond to a distinction in the possibility of occurring in inputs or even in the set of underlying representations, rather it is a distributional generalization holding of outputs that is obtained by the ranking of faith and markedness constraints.

1.4 Organization of the thesis

The organization of the thesis is as follows. Chapter 2 develops a description and analysis of a cross-linguistic typology of nasal harmony. In this chapter I exemplify the hierarchical variation in nasal harmony and present the cross-linguistic generalizations established by a comprehensive survey of nasal harmony patterns. I then go on to construct an optimality-theoretic analysis of the cross-linguistic variation in the sets of targets and blockers, making use of a hierarchy of nasalization constraints and exhausting the possible rankings of a nasal spreading constraint in relation to this hierarchy. The nasal harmony database and its findings are summarized in an appendix to the chapter.

Chapter 3 turns to the matter of analysis of transparent segments. Here I propose that surface transparent outcomes be analyzed as a (derivational) opacity effect. I develop an analysis calling on the ‘Sympathy’ theory approach to opacity effects in OT (McCarthy

1997 with extensions by Itô and Mester 1997a, b). While adopting many of the core ideas of standard Sympathy theory, I propose a revised model for designating the sympathy candidate: this revised model is called *harmonic sympathy*. Tuyuca, a Tucanoan language of Colombia, forms a case study in this chapter for transparency and blocking in nasal harmony.

Chapter 4 presents an acoustic study of Guaraní, a Tupí language of Paraguay. This acoustic investigation first establishes that so-called ‘transparent’ voiceless stops in the nasal harmony of the language are in fact surface-oral, verifying that there is truly a need to obtain transparency in the output. The chapter goes on to report on a comparison of other acoustic features of voiceless stops in oral versus nasal vocalic environments. It is discovered that while voiceless stops remain oral between nasal vowels, there are context-dependent differences in voice onset time and closure duration. These results signal the need for a distinction between phonological representations and phonetic outcomes, and they also have implications for the phonetic correspondents of phonological features.

In chapter 5 I consider other proposals for the analysis of transparent segments and the typology of nasal harmony. Finally, in chapter 6 I examine other phenomena that may be mistaken for nasal harmony but I argue are not instances of nasal feature spreading. A nasal agreement phenomenon in Mbe forms a case study. Phonological and morphological evidence from the language is assembled to support an analysis of the nasal agreement as a case of nasal copy, i.e. reduplication. The limitation of copy to a nasal segment is shown to fall out from independently-motivated rankings in the language and constraint rankings predicted by factorial typology. The chapter concludes with a brief examination of long-distance nasal agreement effects in some Bantu languages, and it is suggested that these are instances of cooccurrence effects. A direction for further pursuit of this approach is outlined.

Chapter 2

A CROSS-LINGUISTIC TYPOLOGY OF NASAL HARMONY

In this chapter I develop a description and analysis of a cross-linguistic typology of nasal harmony, focusing on variability in the set of segments undergoing nasalization and in those that block or behave transparent to nasal spreading. Across these variables, I propose to unify our understanding of nasal harmony as conforming to one basic type of pattern. As the basis for this study, I have compiled a database of nasal harmony systems, which comprises descriptions from over 75 languages. Each language entry includes information about the inventory of segments, the set of segments undergoing nasalization, and any blocking or transparent segments. The cross-linguistic generalizations established in this research define the facts to be explained by the analysis. These facts are summarized in this chapter and a condensed version of the database itself is appended.

Two central theoretical points illuminate the unified account of nasal harmony. First, building on previous studies of the compatibility of nasalization with different segments, it is argued that cross-linguistic variation in nasal harmony is limited by a phonetically-grounded hierarchy which ranks segments in terms of their harmonicity under nasalization. After nasal stops, vowels are ranked as most compatible with nasalization in this hierarchy. Obstruents, on the other hand, are ranked as least compatible. The nasalization hierarchy is implicational in the sense that if a segment undergoes nasal spreading, all segments more compatible with nasalization will also be targetted. The hierarchy is analyzed in an optimality-theoretic framework as composed of intrinsically-ranked nasal feature cooccurrence constraints. Variation in the set of undergoing segments is then derived by ranking the nasal spreading constraint at different points in the constraint hierarchy, generating just the variability which is attested.

The second point concerns transparent segments in nasal harmony. To begin, there appears to be a gap in the set of variants predicted by the implicational hierarchy: there is no language in which all segments are nasalized in nasal harmony (see second row in (1a)). Also, as diagrammed in (1a), the typology of nasal harmony outlined here finds that while the majority of segments either block spreading or become nasalized, some obstruents (typically voiceless ones) behave differently, either blocking or behaving transparent. When transparent, obstruents remain oral but permit the continuation of nasal spreading. These two observations fit together like pieces of a puzzle: systems with a set of transparent segments form the *complement* to those with blocking segments. To explain this complementarity, it is proposed that systems with transparent obstruents fill the gap of a system targetting all segments, i.e. transparent obstruents should be understood as belonging to the set of segments *undergoing* nasal harmony, as outlined in (1b).

- (1) a. Observed possible patterning of segments in nasal harmony:

	Vocoids	Liquids	Obstruents	
Blockers (block spreading)	✓	✓	✓	
Targets (become nasalized)	✓	✓	✓	✗
Transparent segments (remain oral, do not block)	✗	✗	✗	✓

- b. Proposed analysis of segmental behavior in nasal harmony:

	Vocoids	Liquids	Obstruents
Blockers (block spreading)	✓	✓	✓
Targets (undergo [nasal] spreading)	✓	✓	✓

Factorial ranking in the optimality-theoretic framework (Prince and Smolensky (1993)) predicts the possibility of a grammar in which nasal spreading would be ranked high enough to derive even nasalized segments at the extreme of incompatibility. With this move, nasal harmony is unified into a basic pattern in which segments simply either undergo or block, and all possible variations produced by different rankings are attested. In this unified analysis of the typology, transparency arises as a resolution for an incompatible segment that undergoes nasal spreading.

In further support of this claim, it is observed that there is an implication in the occurrence of voiceless transparent obstruents and the behavior of other segments. When voiceless obstruents behave transparent to nasal harmony, all other classes of segments undergo nasalization, that is, they exhibit a nasal alternant in nasal contexts. Voiceless obstruents never behave transparent when segments more compatible with nasalization block nasal spreading. As I will show, this asymmetry suggests that all segments, including obstruents, are targeted by nasalization in these languages. Importantly, the finding that descriptively transparent segments pattern with undergoers lends support to phonological studies arguing that spreading or sharing of structure can never skip an intervening segment, a result derived by claiming that a gapped configuration in feature linking is universally ill-formed (Ní Chiosáin and Padgett 1997; cf. Gafos 1996 on Articulatory Locality; for foundation, see analyses of Ní Chiosáin and Padgett 1993; McCarthy 1994; Flemming 1995b; Padgett 1995a; also Allen 1951; Stampe 1979). The surface-transparent resolution for transparent segments, while still maintaining locality, is worked out in chapter 3.

This chapter is organized as follows. First in section 2.1 I present the descriptive facts, exhibiting the hierarchical cross-linguistic variation in nasal harmony and summarizing the key generalizations established by the nasal harmony database. Next, in 2.2, I develop an analysis of the typology, using an intrinsically-ranked hierarchy of

nasalized segment constraints. Ranking the nasal spreading constraint at all possible points in this hierarchy proves to derive precisely the typology that is required. In section 2.3, I adduce further evidence for the nasalization hierarchy by exploring examples in which separate constraints are ranked at different points in the fixed hierarchy. Finally, in the appendix in 2.4 I present a condensed version of the nasal harmony database and discuss some of the findings from this survey in more detail.

2.1 Hierarchical variation in nasal harmony

The behavior of segments in nasal harmony falls into three descriptive categories: *target segments* are those that undergo nasal spread, *blocking segments* remain oral and block nasal spreading, and *transparent segments* remain oral but do not block nasalization of subsequent segments. In this section I show that languages which divide their segments exhaustively into blockers and targets exhibit limited variation in the content of these sets. One limitation is that the set of blockers always includes obstruent stops. This at first appears to deny the prediction that all possible variants in the typology should be attested (formalized in Optimality Theory as the factorial typology hypothesis; Prince and Smolensky 1993) — the expectation is that there should be a language in which obstruent stops belong to the set of targets and undergo nasal spreading. A central insight in this examination of the typology is that systems with transparency form the *complement* to those just mentioned by including all consonants, including obstruent stops, in the set of segments which nasalization spreads through, i.e. the set of segments that become nasalized or are ‘skipped’. This forms the basis for the argument that systems with blocking and systems with descriptively transparent segments are of one basic type in which all segments are grouped into either the set of blockers or the set of targets: otherwise the complementary relationship between these systems would be accidental.

Central to this claim is the idea that variation in nasal harmony must adhere to a hierarchy of segments.

As discussed in Walker (1995), previous surveys of nasalization (Schourup 1972; Piggott 1992; Cohn 1993c; cf. also Pulleyblank 1989) find that variation in the sets of supralaryngeal targets and blockers in nasal harmony obeys the implicational hierarchy in (2), where for each division, marked by a numeric label, all segments to the left will be targets, while those to the right will block.

(2) Implicational nasalization hierarchy:

① Vowels ② Glides ③ Liquids ④ Fricatives ⑤ Obstruent Stops ⑥
 ← high—————compatibility with nasalization—————low →

In previous work this hierarchy of segments has only been assumed to apply to systems with blocking, separating them from systems with transparency. However, I will propose that this basic hierarchy governs variation in all nasal harmony. The typology of variation that will be developed here posits all nasal harmony as strictly local, unifying the harmony systems exhibiting blocking with those with transparency. The claim underlying this proposal is that skipping of segments does not occur, so all non-participating segments are blockers. ‘Transparent’ segments, on the other hand, pattern with the set of targets in allowing nasalization to spread through them. In systems with no blockers but some descriptively transparent segments, all segments thus behave as undergoers, which will be another variation conforming to the hierarchy in (2).

I begin by exemplifying hierarchical variation in systems with a set of segments that block nasal spreading. Sundanese, a Malayo-Polynesian language spoken in Western Java, provides an example of the most limited nasal harmony, in which only vowels participate and the remaining supralaryngeals block (see (3)) (examples e, f, g, and h are

due to Cohn 1990, all others are from Robins 1957). The consonantal inventory for Sundanese is as follows: [p, b, t, d, t̪̃, d̪̃, k, g, s, m, n, ɲ, ŋ, l, r, j, w, h, ʔ] (distribution of the glottal stop is not phonemic: Robins 1957). In Sundanese nasalization spreads rightward from a nasal stop. In these and subsequent examples nasalization is marked on segments with a tilde. In nasal contexts I show a tilde on the glottal segments [h] and [ʔ]. The status of glottals in nasal harmony will be addressed in section 2.2.3.

(3) Sundanese

a.	ɲãĩã̃n	‘to wet’
b.	kumãhã̃	‘how?’
c.	bɤŋhã̃r	‘to be rich’
d.	mĩʔã̃sih	‘to love’
e.	ŋãjak	‘to sift’
f.	mãwur	‘to spread’
g.	mõlohok	‘to stare’
h.	mãro	‘to halve’
i.	ŋũdag	‘to pursue’
j.	ŋãtur	‘to arrange’

The Johore dialect of Malay, another Malayo-Polynesian language, illustrates the second variation, in which glides also undergo a rightward spreading of nasality from a nasal consonant (Onn 1980). Liquids and obstruents block spreading. The Malay inventory contains the following consonants [p, b, t, d, t̪̃, d̪̃, k, g, s, m, n, ɲ, ŋ, l, r, j, w, h, ʔ] (glottal stop is again non-phonemic).

(4) Malay (Johore dialect)

- | | | |
|----|-----------|-----------------------|
| a. | mĩnõm | ‘to drink’ |
| b. | baŋõn | ‘to rise’ |
| c. | mãĩãp | ‘pardon’ |
| d. | pənəŋãhãn | ‘central focus’ |
| e. | mãjãŋ | ‘stalk (palm)’ |
| f. | mənãwãn | ‘to capture’ (active) |
| g. | məratappi | ‘to cause to cry’ |
| h. | pəŋãwãsan | ‘supervision’ |
| i. | mãkan | ‘to eat’ |

Ijo, a Kwa language of Nigeria, is an example of the third variation, where liquids are added to the set of undergoing segments (Williamson 1965, 1969b, 1987). In this language, nasality spreads from a nasal consonant or nasal vowel. Unlike the rightward spread of the two previous examples, nasal spreading is leftward in Ijo. Examples of nasal harmony from the Central Ijo Kolokuma dialect are given in (5). The consonant inventory is as follows: [p, b, t, d, k, g, k̄p, ḡb, f, v, s, z, ɣ, m, n, ŋ, r, l, j, w, h]. Nasalization of the flap is shown in examples (d-e). Williamson (1987: 401) notes that before a vowel [l] and [n] are in complementary distribution, [l] occurring before oral vowels and [n] before nasal. In nasal vocalic environments she posits /l/ as nasalizing to [n].

(5) Ijo (Kolokuma dialect)

- | | | |
|----|------|---------------------|
| a. | ũmba | ‘breath’ |
| b. | ãnda | ‘wrestle’ |
| c. | wãĩ | ‘prepare sugarcane’ |

d.	jāṛī	‘shake’
e.	sōṛō	‘five’
f.	sānlo	‘gills’
g.	izōŋgo	‘jug’
h.	abāmu	‘loft’
i.	otōŋgbolo	‘mosquito’
j.	tōnī	‘light (a lamp)’

The Applecross dialect of Scottish Gaelic, a Celtic language spoken in Scotland, illustrates the fourth variation in which nasalization carries through fricatives (Ternes 1973). Nasality spreads rightward from a stressed nasal vowel (usually in the initial syllable) until checked by an obstruent stop. It also nasalizes the onset of the syllable containing the stressed vowel, provided the onset is not an obstruent stop.¹ Examples are given in (6). Three vowel lengths are distinguished: one raised triangle marks half-long, two triangles mark long, and short vowels are unmarked. The inventory contains the following consonants: [p, p^h, b, b^h, t, t^h, d, d^h, tʲ, tʰ, dʲ, dʰ, kʲ, kʰ, ɡʲ, ɡʰ, k, k^h, ɡ, ɡ^h, f, v, s, ʃ, ç, ʝ, x, ɣ, m, n, nʲ, ŋ, r, R, l, lʲ, L, j, h] (voiced aspirated stops are used by conservative speakers only).

(6) Scottish Gaelic (Applecross dialect)

a.	/mā·har/	[mā·hāṛ]	‘mother’
b.	/tʲianu/	[tʲiānū]	‘to do, to make’
c.	/frīa·v/	[frīā·v̄]	‘root’ (plural)
d.	/ʃēne·var/	[ʃēnēvāṛ]	‘grandmother’

¹ Ternes notes some complexities in relation to the mid-high vowels. These will be discussed in section 2.4.

e.	/Lā:j/	[ɽā:ǰ]	‘hand’
f.	/āhuç/	[āhūç̣]	‘neck’
g.	/sŋā·n ^ɰ d ^ɰ an/	[sŋā·n ^ɰ d ^ɰ an]	‘thread’
h.	/t ^h āhusk/	[t ^h āhūšk]	‘senseless person. fool’
i.	/strāi·γ/	[stṛāi·ṽ]	‘string’
j.	/k ^h ɔ̄ispaxk/	[k ^h ɔ̄iṣpaxk]	‘wasp’ ²

The above examples illustrate four hierarchical variations in the set of segments undergoing nasal harmony. In general terms, the hierarchy governing the variants has five segmental classes: Vowels, Glides, Liquids, Fricatives, and Obstruent Stops, where each variation in the set of participating segments corresponds to a step in the hierarchy (see (2)). Yet there is a further step at either end of the hierarchy which must also be considered. The remaining step at the left or top end corresponds to a variant in which all segments block nasal spreading. This will be a language with no nasal harmony, such as Spanish (Standard). At the opposite extreme there is a step corresponding to a variant targetting all segments. Yet there appears to be no surface-true example of this kind of case, which is unexpected given the assumption in Optimality Theory that all constraint rankings are possible. In fact, I claim that there are examples which could be reasonably slotted in this last category. I propose that nasal harmony in which no segments block nasal spreading and some obstruents behave transparent is an instance of this case. This kind of pattern occurs in Tuyuca.

Tuyuca is a Tucanoan language spoken in Colombia and Brazil (Barnes and Takagi de Silzer 1976; Barnes 1996).³ Its inventory of consonants is as follows [p, b, t, d, k, g,

² The transcriptions in (6) follow Ternes, who asserts that voiced and voiceless fricatives are nasalized and fricated in nasal spreading. For more general discussion of nasalized fricatives see section 2.4.

³ Thanks to Geoff Pullum for first bringing the Tuyuca data to my attention.

m, n, ŋ, s, r, w, j, h] with nasal and voiced stops in complementary distribution in outputs, as defined by nasal harmony contexts (Barnes 1996: 33). Morphemes in Tuyuca are descriptively characterized as nasal or oral as a whole, as in (7). Within an oral morpheme, all segments are oral; in a nasal morpheme, all segments are nasal except for voiceless obstruents. In oral morphemes, all voiced stops are produced as oral obstruent stops and in the output of nasal morphemes, all voiced stops are fully nasal sonorant stops. Because nasality spreads to all nasalizable segments in a nasal morpheme, it is impossible to unambiguously pinpoint the segment from which nasal spreading originates. For ease of exposition, I will simply assume that nasality originates from a nasal vowel or stop in the first syllable in a nasal morpheme (Tuyuca vowels are [i, ī, u, e, a, o], each with a nasal counterpart).⁴ In Tuyuca, spreading from the trigger segment is bidirectional, and it is not blocked by any segments within the morpheme. Voiceless obstruents are transparent to the nasal harmony in the sense that they always surface as oral and yet they do not prevent nasalization from spreading past them to other segments in a nasal morpheme.

(7) Tuyuca

<u>Oral</u>		<u>Nasal</u>	
a.	wáa 'to go'	n.	wǎǎ 'to illuminate'
b.	watí 'dandruff'	o.	wǎtí̄ 'demon'
c.	hoó 'banana'	p.	hōó 'there'
d.	keeró 'lightning bug'	q.	kēērǒ 'a dream'
e.	osó 'bat'	r.	jǒsǒ 'bird'
f.	botá 'post'	s.	ēmǒ 'howler monkey'
g.	padé 'work'	t.	wǐnǒ 'wind'

⁴ Alternatively, Barnes suggests that the feature of nasality is affiliated underlyingly with the entire morpheme (1996: 31).

h.	sigé	'to follow'	u.	tĩŋó	'Yapara rapids'
i.	siá	'to tie'	v.	sĩá	'to kill'
j.	peé	'to bend'	w.	pěé	'to prepare soup'
k.	bipí	'swollen'	x.	mĩpĩ	'badger'
l.	dití	'to lose'	y.	nĩtĩ	'coal'
m.	aká	'give food'	z.	āká	'choke on a bone'

In attributing a special status to the first syllable, I follow Beckman (1995, 1997, 1998), who finds that the root-initial syllable often has a privileged status in triggering spreading and resisting change to its own featural specification. Beckman suggests that this is a consequence of faithfulness constraints that are position-sensitive, where the availability of such positions is defined by perceptual facilitation (drawing on observations of Steriade 1993c). Position-sensitive faithfulness will be discussed in more detail in chapter 3. Independent evidence for a special status of the first syllable in Tucanoan languages comes from nasalization in another Tucanoan language, Orejon (dialect described by Arnaiz 1988 and discussed in Pulleyblank 1989). In Orejon, nasality in vowels clearly originates in the first syllable and spreads to the right across a continuous sequence of voiced segments; voiceless segments block spreading. Importantly, nasalization is contrastive for vowels only in the initial syllable.

I assume that both voiced oral and nasal stops are 'phonemic' in Tuyuca, i.e. they may both occur underlyingly. This will be motivated as the analysis develops: I posit underlying nasal stops since they are the best kind of segment with nasality and nasal vowels also occur in the language (cf. Ferguson 1963, who finds that the presence of nasal vowels almost always implies the occurrence of nasal stops in a language); also, evidence will be presented for the occurrence of underlying voiced obstruent stops. The surface

complementary distribution of nasal and voiced stops is thus not a consequence of restrictions on underlying representations, but a consequence of nasal harmony. The nasalization of all voiced stops in nasal morphemes shows that obstruent stops are capable of actually undergoing nasal spreading. The existence of voiced stops with an obstruent status in Tuyuca is indicated both by the obstruent-realization of voiced stops in oral morphemes and by the patterning of voiced stops in nasal spreading across morphemes. In cross-morphemic spreading in Tuyuca, suffixes behave in one of two ways: they either take on the nasal quality of the stem to which they are affixed (8) or they are fixed in their nasality (9) (there are no prefixes in Tuyuca).

(8) Nasality alternations with /-ri/ 'imperative of warning'

a. Oral suffix alternant with oral stem

/tutí - ri/ → [tutíri] 'watch out or you will get scolded!'
scold - imp. of warning

b. Nasal suffix alternant with nasal stem

/hĩĩ - ri/ → [hĩĩĩ] 'watch out or you will get burned!'
burn - imp. of warning

(9) Suffixes with fixed nasality

a. Fixed oral suffix

/wāká - go/ → [wākāgó] 'she awakens'
wake up - evidential

b. Fixed nasal suffix

/koa - mā/ → [koamá] 'allow me to dig'
dig - imp. of permission

A list of some Tuyuca suffixes by their nasalization categories is given in (10-11). Interestingly, suffixes that alternate exclude ones with initial stops or fricatives.⁵ As Barnes (1996: 34) observes, this indicates that obstruents block nasal spread from stem to suffix, otherwise the gap of obstruent-initial suffixes in the alternating set would be purely accidental.

(10) Alternating suffixes:

- a. -a animate plural
- b. -ha contrast
- c. -ja imperative
- d. -wi evidential
- e. -wo evidential
- f. -ri imperative of warning
- g. -re specifier
- h. -ro adverbializer
- i. -ra pl. nominative

(11) Fixed oral suffixes:

- a. -a recent past
- b. -ja evidential
- c. -wi classifier

Fixed nasal suffixes:

- o. -hã emphatic
- p. -ɲã try
- q. -wĩ singularizer

⁵ Voiced velar stops behave somewhat differently from the others, because they can occur in alternating suffixes. Barnes gives the example, /-go/, a dependent verb suffix, which is realized as [gɔ] after an oral morpheme and [ŋõ] after a nasal morpheme (1996: 35). Trigo (1988) offers a possible explanation. In her discussion of the related language, Tucano, which exhibits the same suffixal blocking effects, she argues that the velar nasal alternant is actually a placeless nasal segment, and thus belongs to a separate class from the stops. It has also been suggested that voiced velars tend to become nasalized in order to overcome the difficulty in maintaining voicing when there is a posterior oral closure. This has been hypothesized in regard to the [g] ~ [ŋ] allophony in Tokyo Japanese, where voiced velar stops occur as oral word-initially and nasal medially (McCarthy and Prince 1995; Itô and Mester 1997c).

d.	-wo	classifier	r.	-wō	classifier
e.	-ri	inanimate sg. nominative	s.	-rī	time(s)
f.	-re	inanimate pl. nominative			
g.	-sa	classifier	t.	-sā	continue action
h.	-ba	classifier	u.	-mā	classifier
i.	-da	classifier	v.	-nā	at that instant
j.	-ga	evidential	w.	-ŋā	diminutive
k.	-go	evidential			
l.	-pi	too much	x.	-pī	classifier
m.	-to	evidential	y.	-tō	classifier
n.	-ka	large inanimate sg.	z.	-kā	also

The fact that voiced stops pattern with the obstruents in blocking nasal spread across morphemes is strong evidence that when oral they are obstruents themselves. This blocking effect would be wholly unexpected if oral voiced stops were posited as underlyingly oral sonorants rather than obstruents in Tuyuca, as Piggott (1992) and Rice (1993) have proposed for the related Tucanoan language, Southern Barasano. Sonorant stops, a set which includes nasals like [m] or [n] and possibly oral sonorant counterparts (as Piggott and Rice suggest), are highly compatible, indeed the best, with nasalization and would not be expected to block nasal spreading when less compatible segments such as glides and liquids undergo. On the other hand, obstruent stops are low on the scale of compatibility with nasalization, so they should only undergo nasalization when all segments that are more compatible do as well — this is the case within Tuyuca morphemes. Further, they are expected to be amongst the first classes of segments to block nasal spreading, consistent with their behavior in cross-morphemic harmony.

Nasal harmony within Tuyuca morphemes provides an example in which nasal spreading targets all classes of segments, including obstruents. This completes the exemplification of the hierarchical typology, summarized in (12).

(12) Hierarchical typology of nasal harmony

1 Vowels ___ Glides ___ Liquids ___ Fricatives ___ Obstruent stops ___ 1 *Spanish*

___ Vowels 2 Glides ___ Liquids ___ Fricatives ___ Obstruent stops ___ *Sundanese*

___ Vowels ___ Glides 3 Liquids ___ Fricatives ___ Obstruent stops ___ 3 *Malay (Johore)*

___ Vowels ___ Glides ___ Liquids 4 Fricatives ___ Obstruent stops ___ 4 *Ijo (Kolokuma)*

___ Vowels ___ Glides ___ Liquids ___ Fricatives 5 Obstruent stops ___ 5 *Gaelic (A.cross)*

___ Vowels ___ Glides ___ Liquids ___ Fricatives ___ Obstruent stops 6 6 *Tuyuca*

← UNDERGOERS ————— BLOCKERS →

All of the variation in the set of non-undergoing (blocking segments) conforms to the one fixed hierarchy of segments and all variations given by the hierarchy are attested. An analytical assumption I make for this typology is that all nasal harmony is strictly segmentally local, so the only possible outcome for a segment failing to participate in nasal harmony is for it to block spreading. Because of the strict locality, descriptively transparent segments will not be skipped but should be grouped with the segments that actually undergo harmony, so in Tuyuca, I claim that 'transparent' voiceless obstruents should be regarded as segments that participate in nasal harmony. This claim is key to achieving a complete typology with all hierarchical variants.

In order to verify the cross-linguistic application of this hierarchical typology, I compiled a database of nasal harmony patterns in over 75 languages, building on the background of surveys by Schourup (1972); Cohn (1993c), Piggott (1992) (among other

foundational work cited in 2.4). Patterns included in this database are those in which nasalization spreads across syllables or targets nonvocalic segments in the syllable. A condensed version of the database and discussion of its findings are given in an appendix to this chapter in section 2.4. I summarize here the key findings and relate them to the typology in (12).

The focal finding of the database is that variation in nasal harmony across languages bears out the implicational hierarchy outlined in (2). The study finds that if a segment blocks nasalization, all segments less compatible by the nasalization hierarchy will also block nasal spreading. Further, if a segment undergoes nasalization or behaves transparent, all segments more compatible with nasality will undergo nasal spreading. Importantly, transparency effects are limited to the class of obstruents, that is, only obstruents have ever been shown to surface as oral within a nasal harmony span; other segments become nasalized in this context. Obstruents are precisely the class for which there appears to be no example of nasalization of all segments, an unexpected gap under the assumption that all possible variants given by the implicational hierarchy actually occur. Filling this gap motivates the claim that transparent segments are ‘undergoers’ or targets of nasalization, so a language in which all segments are nasalized with the exception of some transparent obstruents corresponds to a language in which all segments undergo nasal harmony. We thereby derive a complete typology, in which all hierarchical variants are attested, and at the same time we explain the essentially complementary relationship between segments that become nasalized in nasal harmony and those that behave transparent. In addition, we derive the parallel implication in these two sets of segments whereby if a segment becomes nasalized or behaves transparent, all more compatible segments also undergo nasalization.

The cross-linguistic generalizations thus support the hierarchical view of variation and the proposal that transparent segments should be understood as targets of nasal

spreading. In chapter 3 I argue that transparency only occurs as the result of an opaque constraint interaction: one that arises to resolve a conflict between fully satisfying the nasal spreading constraint and avoiding violation of the constraint against nasalized obstruents. In the remainder of this chapter, I focus on the analysis of the undergoing and blocking behavior of segments

2.2 Analysis of the typology

The typology established by the database confirms that cross-linguistic variation in nasal harmony obeys the implicational hierarchy in (2). On the subject of transparent segments it shows that obstruents are the only segments to ever behave transparent to nasal harmony, and when they act transparent, all higher-ranked segments in the hierarchy undergo nasalization — they never block under these circumstances. This is explained by treating descriptively transparent segments as undergoers of nasal spreading. As undergoers, they are only expected to be targetted in nasal harmony when all higher-ranked segments are as well. This model of the typology yields one in which all variants given by the implicational hierarchy are attested. In this section, I develop an optimality-theoretic analysis of the hierarchical typology.

2.2.1 The constraints

To characterize the basic typology of nasal harmony, two kinds of constraints will be required: spreading constraints and nasal markedness constraints. I begin by examining the markedness constraints, arguing that they are arrayed in a hierarchy according to the compatibility of certain feature combinations with nasalization. I then go on to the formulation of the spreading constraint. Factorial ranking of the spreading constraint in relation to the nasal markedness hierarchy will derive the cross-linguistic variation. I defer discussion of faith constraints until section 2.3.

Drawing on a proposal initially made by Schourup (1972). I assume that all variation in the set of target segments in nasal harmony is based on the phonetically-grounded universal harmony scale of nasalized segments in (13), which corresponds to the implicational hierarchy in (2). (The notion of a ‘harmony scale’ is after Prince & Smolensky 1993. Hierarchical (in)compatibility is also discussed in Pulleyblank 1989; Piggott 1992; Cohn 1993a, c; Padgett 1995c; Walker 1995. See also Hume & Odden 1994 for a somewhat different yet related hierarchy based on impedance.)

(13) *Nasalized segment harmony scale*

- a. nasal sonorant stop > nasal vowel > nasal glide > nasal liquid >
nasal fricative > nasal obstruent stop
- b. A possible elaboration in featural terms:
nasal sonorant stop [+nas. +son. -cont] > nasal vowel [+nas. +approx.
-cons. +syll] > nasal glide [+nas. +approx. -cons. -syll] > nasal liquid
[+nas. +approx. +cons] > nasal fricative [+nas. +cont. -son] > nasal
obstruent stop [+nas. -cont. -son]

(13a) gives the harmony scale segregated by segmental class. In general nasal spreading appears to make class-based distinctions in the segments it targets. If it were necessary to make finer-grained distinctions by ranking nasalization of individual segments, this hierarchy could be made more detailed; however, this does not usually seem to be called for in nasal harmony. (13b) gives content to the segmental classes of (13a) in featural terms (the particular choice of features here is not crucial to what follows). It is important to note that in (13) [+nasal] is simply combined with the other feature specifications describing a

given class of sounds, for example, a nasalized liquid will be [+approximant] in the output and a nasalized obstruent will be [-sonorant].

The nasalized segment hierarchy reflects the fact that a sonorant stop is most compatible with nasality and is most widely attested across inventories (Ferguson 1963, 1975; Maddieson 1984; Pulleyblank 1989; Cohn 1993a). In fact, it is not clear whether sonorant stops (e.g. [n]) ever occur without nasalization (but see Piggott 1992 and Rice 1993 for some suggested instances; as noted in the database, Ewe may also provide a case). Vowels are the next most widely attested nasal segment and are the most susceptible to acquiring nasalization in nasal spreading. The relative harmony of nasalized segments decreases gradiently through the hierarchy, ending with nasalized obstruent stops. Notice that although the ranking in (13) closely resembles the sonority hierarchy (see e.g., Sievers 1881; Jespersen 1904; Hooper 1972, 1976; Hankamer and Aissen 1974; Basbøll 1977; Steriade 1982; Selkirk 1984; Levin 1985; Zec 1988; Clements 1990), it crucially differs in the ranking of nasal sonorant stops, and thus the two cannot be fully equated. However, Cohn (1993a) notes that sonority plays a role in determining the compatibility of nasalization with continuants. Also, in the nasal harmony database it was observed that there can be language-particular variability in the ranking of voiced stops and voiceless fricatives which seems to correspond to variability in the sonority hierarchy (this will be discussed in section 2.4). I suggest that this similarity stems from both the sonority hierarchy and the nasalization hierarchy having an overlapping basis in perceptibility. In the case of sonority, the basis of perceptibility is something like acoustic intensity. For the nasalization hierarchy the scale reflects nasal perceptibility (in addition to articulatory compatibility, as noted below). A nasal stop will be the best segment in conveying perceptible nasalization, since the acoustic properties of a nasal stop stem solely from nasal airflow. For continuant segments, nasal airflow is combined with oral airflow. Here it

seems that perceptibility of nasality is enhanced by greater sonority, hence the overlap in the two hierarchies.

Overall, it is both articulatory/aerodynamic and acoustic/perceptual factors that contribute to the basis for the nasalization hierarchy, as noted by Cohn (1993a). For example, it is difficult to produce an audibly nasalized fricative because such a sound segment has articulatory/aerodynamic and acoustic/perceptual demands that are hard to satisfy at the same time. The nasal property requires that the segment be produced with a lowered velum, and nasal airflow undermines the needed build-up of pressure behind the oral constriction to produce frication (Ohala and Ohala 1993; Cohn 1993a; Ohala, Solé, and Ying 1998). As a consequence, perceptible achievement of either nasality or frication generally suffers in the production of nasalized fricatives. In a nasal airflow study of Coatzacoapan Mixtec, Gerfen (1996) finds that nasal airflow can be maintained during a voiceless coronal fricative with strongly audible frication, but the acoustic cues for nasalization are weak — the fricative is typically perceived as oral. On the other hand, nasalized voiced fricatives in Guaraní are produced with clearly perceptible nasalization but they lose audible frication: Gregores and Suárez describe / \bar{v} , \bar{y} , \bar{y}^w / as ‘nasalized frictionless spirants’ (1967: 81-2).

With the harmony scale in (13), we can explain the variation in nasal harmony as variability in where languages make the cut between segments that are sufficiently compatible with [+nasal] to be undergoers and those that are not. Since Optimality Theory is based on the notion of ranked and violable constraints, it is well-suited to capturing this insight (Prince & Smolensky 1993, McCarthy & Prince 1993a). To implement this idea in Optimality Theory, we must recast the ranking of nasal (in)compatibility in terms of the nasalized segment constraint hierarchy in (14), where the less compatible a segment is with nasality, the higher ranked the constraint against it (following Walker 1995; see Prince &

Smolensky 1993 for similar derivations of constraint hierarchies from harmony scales). The approach of using feature cooccurrence constraints to achieve segmental blocking is one that builds on previous work by Kiparsky (1981), Pulleyblank (1989), and Archangeli and Pulleyblank (1994).

(14) *Nasalized segment constraint hierarchy:*

- a. *NASOBSSTOP » *NASFRICATIVE » *NASLIQUID » *NASGLIDE » *NASVOWEL » *NASSONSTOP
- b. A possible elaboration in featural terms:
 *NASOBSSTOP: * [+nas. -cont. -son] » *NASFRICATIVE: * [+nas. +cont. -son] » *NASLIQUID: * [+nas. +approx. +cons] » *NASGLIDE: * [+nas. +approx. -cons. -syll] » *NASVOWEL: * [+nas. +approx. -cons. +syll] » *NASSONSTOP: * [+nas. +son. -cont]

The feature cooccurrence constraints in this hierarchy may be stated in terms of features, as in (14b), but I will refer to the categories in (14a) for ease of exposition. Thus, *NASFRICATIVE, for example, refers to the constraint prohibiting the combination of features: [+nasal, +continuant, -sonorant]. Such constraints could be derived by conjunction of markedness constraints against individual features, i.e. * [+nas]&[-son]&[+cont] (conjunction after Smolensky 1995, 1997), although constraint conjunction need not be crucially assumed here. In section 2.4 it will be noted that there may need to be some limited variability in the ranking amongst constraints against nasalized obstruents.

The nasalized segment constraints will conflict with the constraint driving the spread of [+nasal]. In autosegmental representations it is generally assumed that spreading

produces an outcome in which a feature is *multiply-linked* across a span of segments, as schematically illustrated in (15). Importantly, spreading does not produce *copying* of a feature specification onto neighboring segments, producing separate occurrences of the feature specification, as shown in (16). The output representation in (16) is also to be avoided on the basis of OCP violations.

(15) The multiply-linked outcome of feature spreading:

INPUT S₁ S₂ S₃
 |
 [+F]

OUTPUT S₁ S₂ S₃
 \ | /
 [+F]

(16) Feature spreading is not satisfied by feature copying:

INPUT S₁ S₂ S₃
 |
 [+F]

* OUTPUT S₁ S₂ S₃ Spreading has failed for each feature occurrence
 | | |
 [+F] [+F] [+F]

To achieve the multiply-linked outcome of spreading, the spreading constraint needs to make reference not just to feature specifications but to individual *occurrences* of feature specifications. The output in (15) has one occurrence of the feature specification [+F], while the output in (16) has three occurrences of [+F]. The spreading constraint must demand that each feature occurrence be linked to every segment in some domain, such as the morpheme or Pwd (Padgett 1995b proposes a constraint modelled along these lines).

This distinguishes the required outcome in (15) from the undesired one in (16). I propose to formulate the general spreading constraint as in (17)⁶.

(17) SPREAD[F, D]

Let f be a variable ranging over occurrences of the feature specification F , and S be the ordered set of segments $s_1 \dots s_k$ in a domain D . Let $\text{Assoc}(f, s_i)$ mean that f is associated to s_i , where $s_i \in S$.

Then SPREAD[F, D] holds iff

- i. $(\forall s_i \in S) [[\exists f (\text{Assoc}(f, s_i))] \rightarrow [(\forall s_j \in S) [\text{Assoc}(f, s_j)]]]$.
- ii. For each feature occurrence f associated to some segment in D , a violation is incurred for every $s_j \in S$ for which (i) is false.

The spreading constraint in (17) expresses the requirement that for any segment linked to an occurrence of a feature specification F in some domain D , it must be the case that all other segments in D are also linked to the same occurrence of F . This constraint is satisfied in the output of (15) but is violated in (16). The statement in part (ii) of the constraint defines how violations are to be tallied (following Zoll 1996). For every occurrence of F , a violation is reckoned for each segment to which that occurrence is not linked. In (16), a total of six violations are accrued with respect to spreading: each of the three feature occurrences in the output incurs two violations, one for each segment to which a given feature occurrence is not linked. It should be noted that some analysts have formulated feature spreading constraints in terms of generalized alignment constraints (proposed by Kirchner 1993 with applications by Pulleyblank 1993, 1996; Akinlabi 1996, to appear; Itô and Mester 1994; Cole and Kisseberth 1994, 1995; Walker 1995; Beckman 1998; cf. Ringen and Vago 1997). This is an alternative way of formulating feature spreading and

⁶ I am grateful to Geoff Pullum for suggestions concerning the formal statement of this constraint.

for nasal harmony would not be crucially different from use of the spreading constraint expressed above and in what follows.

The specific kind of feature spreading we are concerned with is spreading of the feature specification, [+nasal]. An example of a nasal spreading constraint is given in (18). This constraint is formulated to spread nasal within the domain of the morpheme, a spreading constraint needed to obtain nasalization in morphemes in Tuyuca.

(18) SPREAD[+nasal, M]

Let f be a variable ranging over occurrences of the feature specification [+nasal], and S consist of the ordered set of segments $s_1 \dots s_k$ in a morpheme M . Let $\text{Assoc}(f, s_i)$ mean that f is associated to s_i , where $s_i \in S$.

Then SPREAD[+nasal, M] holds iff

- i. $(\forall s_i \in S) [(\exists f (\text{Assoc}(f, s_i)) \rightarrow [(\forall s_j \in S) [\text{Assoc}(f, s_j)])]]$.
- ii. For each feature occurrence f associated to some segment in M , a violation is incurred for every $s_j \in S$ for which (i) is false.

SPREAD[+nasal, M] requires that every occurrence of a [+nasal] feature on a segment in a morpheme be linked to all segments in that morpheme. It says nothing about feature occurrences on segments belonging to separate morphemes. Within a morpheme containing a nasal segment, violations with respect to spreading will be incurred for every oral segment in the output.

The formulation of the spreading constraint so far incorporates nothing explicit about the direction of spreading. For the bidirectional spreading of [+nasal] in Tuyuca morphemes, this is sufficient; the formulation of spreading in (18) correctly targets every segment in the morpheme. Further, as noted by Steriade (1995a), Padgett (1995b), and Beckman (1995, 1997, 1998), in many instances of spreading which appear to be

unidirectional, the direction of spreading can be derived by calling on constraints encoding positional prominence. This is the case, for example, in most systems of vowel harmony, where a feature spreads from a peripheral syllable in the word. However, in some patterns of nasal spreading it is necessary to incorporate directionality into the spreading constraint, so it appears that positional prominence does not always play a role in determining the direction of spreading. Examples occur in the nasal harmony of Sundanese, Malay, and Ijo (exhibited in section 2.1), where nasality spreads in a specific direction from a nasal segment anywhere in the word. The need for making reference to the direction of spreading is particularly clear from comparison of the nasalization patterns in Malay and Capanahua (Panoan, Peru; Loos 1969), which target the same groups of segments but differ in directionality. In (4), we saw that nasalization in Malay spreads progressively from a nasal stop to vowels, glides, and glottals. Capanahua nasalization permeates the same set of segments, but the direction is regressive from a nasal stop, whether from a syllable onset or a syllable coda. Examples are given in (19).⁷

- (19) Capanahua
- | | | |
|----|----------|----------------|
| a. | ṽōnāmpān | ‘I will learn’ |
| b. | pōjān | ‘arm’ |
| c. | bāwīn | ‘catfish’ |
| d. | warān | ‘squash’ |
| e. | bīmu | ‘fruit’ |
| f. | ṽīpōŋki | ‘downriver’ |

⁷ Word-final nasals in Capanahua are deleted but still trigger nasal spreading, so I have shown them in the transcription here. It should be noted that Capanahua also deletes nasals in clusters containing a continuant consonant, in which case it triggers bidirectional spreading. For analysis of this interesting phenomenon, see Loos (1969) and Trigo (1988).

- g. kajatānai? 'I went and jumped'
 h. kuīnt̪ap 'bowl'

To obtain the different direction of spreading in languages like Malay and Capanahua, it must be possible to encode directionality in the spreading constraint. I propose to formulate directional spreading as in (20).

(20) SPREAD-L/R[F, D]

Let f be a variable ranging over occurrences of a feature specification F , and S be the ordered set of segments $s_1 \dots s_k$ in a domain D . Let $\text{Assoc}(f, s_i)$ mean that f is associated to s_i , where $s_i \in S$.

SPREAD-R[F, D] holds iff

- i. $(\forall s_i \in S) [[\exists f (\text{Assoc}(f, s_i))] \rightarrow [(\forall s_j \in S) [j > i \rightarrow (\text{Assoc}(f, s_j))]]]$
 where $1 \leq i, j, \leq n$.
- ii. For each feature occurrence f associated to some segment in D , a violation is incurred for every $s_j \in S$ for which (i) is false.

SPREAD-L[F, D] holds iff

- iii. $(\forall s_i \in S) [[\exists f (\text{Assoc}(f, s_i))] \rightarrow [(\forall s_j \in S) [j < i \rightarrow (\text{Assoc}(f, s_j))]]]$
 where $1 \leq i, j, \leq n$.
- iv. For each feature occurrence f associated to some segment in D , a violation is incurred for every $s_j \in S$ for which (iii) is false.

The formulation of spreading in (20) adds directionality by making reference to the place of a segment within the sequence of segments in the domain. For any occurrence of a feature specification f linked to a segment s_i , SPREAD-R requires that the feature specification

occurrence be linked to any segment s_j which comes *after* s_i in the sequence of segments in the domain D. For s_j to succeed s_i in the sequence, j must be greater than i . SPREAD-L expresses a similar demand but requires that a feature occurrence on s_i be linked to any s_j coming *before* s_i in the sequence.

(21) gives the formulation of the rightward nasal spreading constraint that will be required for Malay.

(21) Spread-R[+nasal, Pwd]

Let f be a variable ranging over occurrences of the feature specification [+nasal], and S consist of the sequence of segments $s_1 \dots s_k$ in the prosodic word P . Let $\text{Assoc}(f, s_i)$ mean that f is associated to s_i , where $s_i \in S$.

Then SPREAD-R[+nasal, Pwd] holds iff

- i. $(\forall s_i \in S) [[\exists f (\text{Assoc}(f, s_i))] \rightarrow [(\forall s_j \in S) [j > i \rightarrow (\text{Assoc}(f, s_j))]]]$
where $1 \leq i, j, \leq n$.
- ii. For each feature occurrence f associated to some segment in P , a violation is incurred for every $s_j \in S$ for which (i) is false.

Let us consider the evaluation of the representations in (22) in relation to this constraint. The structures in (a) and (b) each perfectly satisfy SPREAD-R, because for any segment linked to [+nasal], all segments to the right of it are also linked to that same occurrence of the [+nasal] feature specification. On the other hand, (c) incurs one violation with respect to SPREAD-R, because one segment to the right of S_2 is not linked to [+nasal].

(22) Various feature linking structures

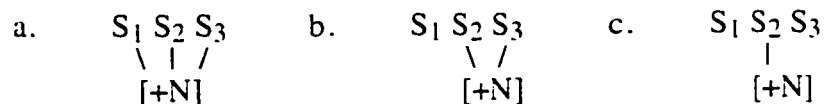

In cases of spreading where directionality need not be stated in the constraint, I will continue to use a simpler formulation like that in (17). Alternatively, this kind of spreading could be captured with two constraints, one spreading to the left and the other to the right.

Interaction of nasal spreading constraints and the nasalized segment constraint hierarchy will derive the hierarchical variation in the typology of nasal harmony. The spreading constraint and nasal markedness constraints conflict in the following way in a word with a nasal segment. Satisfying spreading requires selection of an output containing nasalized segments, violating the markedness constraint. On the other hand, optimizing with respect to markedness means avoiding forming nasalized segments, which forces violation of spreading. Before exhibiting these constraint interactions, however, it is necessary to address the issue of locality of feature spreading. Most phonological theories acknowledge that feature spreading is subject to some kind of locality condition. This is needed to rule out unattested long distance interactions, such as spreading of place features from one consonant to another across vowels. The view of locality that I adopt here is *strict segmental locality*, as termed by Ní Chiosáin and Padgett (1997). Strict segmental locality prevents multiple linking of a feature from skipping an intervening segment.

The motivation for a segmentally strict view of locality is reviewed and argued for in a paper by Ní Chiosain and Padgett (1997). Their work seeks to understand asymmetries in long-distance feature spreading, namely that while features (or gestures) like vowel-place, [nasal], and [aspiration] spread long-distance (i.e. across at least CVC or VCV sequences), others such as [voice] and consonantal major place do not. Focusing primarily on the asymmetry in major place spreading, they find explanation in a view of major place features as inherently specified in oral stricture degree (Browman and Goldstein 1986, 1989; Padgett 1994, 1995c). They show that an important consequence of this assumption is that spreading of consonant major place through vowels will produce

a ‘bottle-neck’ effect, that is, the consonantal stricture of the consonant will be imposed on the vowel, producing an ill-formed syllable nucleus. Combining this with a segmentally strict concept of spreading, they obtain the failure of major consonantal place to spread across vowels.⁸ In contrast, the spreading of vowel major place features through consonants is possible, since superimposing a vocalic degree of stricture on a consonant will still yield a consonant, as the consonantal stricture will be maintained along with a secondary vocalic constriction. This is supported by coarticulation studies which find that vocalic gestures normally overlap consonants (e.g. Öhman 1966). Ní Chiosáin and Padgett present a detailed examination of Turkish vowel harmony, arguing that the vowel place spreading does not skip any segments and permeates consonants as well as vowels. They demonstrate that the apparent ‘transparency’ of consonants to the vowel harmony can be understood from the perspective of segment realization and contrast, which they work out in the framework of Dispersion Theory (Flemming 1995a). This independently-motivated realizational explanation contributes to theoretical parsimony by eliminating any need for a transparency-specific segment skipping device.

At this point we may note that the cross-linguistic typology of nasal harmony is highly suggestive of the segmentally strict view of locality. It has shown us that nasality spreads from segment to segment. Importantly, apparent skipping of segments in nasal spreading does not occur as an alternative to *blocking* for non-undergoers, rather systems with descriptively transparent segments fill the slot where we expect to find all segments *undergoing* nasalization. The set of segments that may become nasalized and those that behave transparent are essentially in complementary distribution. This is explained if transparency occurs as a realization of a segment near the extreme of incompatibility with

⁸ Following Gafos (1996) and Flemming (1995b), Ní Chiosáin and Padgett point out that coronal consonant harmonies do not involve spreading of a major consonantal place, but rather features involving tongue shape or orientation (characterized by some analysts as [anterior] or [distributed]), which do not entail spreading of stricture as well.

nasalization when it undergoes nasal spreading. Positing ‘transparent’ segments as undergoers derives a typology in which all variants given by the implicational nasalization hierarchy are attested. It also explains why voiced stops always undergo nasalization rather than block when voiceless stops behave transparent.

The requirement of segmentally strict locality follows more generally from the claim that a ‘gapped configuration’ like that in (23) is universally ill-formed.

(23) The gapped configuration: universally ill-formed

$$\begin{array}{ccc} \alpha & \beta & \gamma \\ & \backslash & / \\ & [F] & \end{array} \quad \text{where } \alpha, \beta, \text{ and } \gamma \text{ are any segment}$$

In prohibiting a configuration like that in (23), which violates segmental adjacency in feature linking, I follow Ní Chiosáin and Padgett (1993, 1997), Padgett (1995a), and Walker (1996) (McCarthy 1994; Flemming 1995b; and Walker and Pullum 1997 provide foundation; cf. also Allen 1951; Stampe 1979; Gafos 1996). More generally for a call on the ill-formedness of gapping across anchors to constrain locality, see Kiparsky (1981), Levergood (1984), Archangeli and Pulleyblank (1994), and Pulleyblank (1993, 1996), among others. It should be noted that some previous conceptions of locality permit α , β , and γ to be defined as projected targets, allowing skipping of non-target segments (see, for example, Archangeli and Pulleyblank on ‘prosodic transparency’ 1994: 358-9, also feature-geometric approaches make use of elaborated structure below the segment; Piggott 1992); however, under segmentally strict locality, α , β , and γ are interpreted as any segment, so spreading and linking must be between adjacent segments. Building on the insights of Articulatory Phonology (Browman and Goldstein 1986, 1989, 1990), segmental locality corresponds to understanding each instance of a feature specification as representing a continuous occurrence of some property or gesture. If a single instance of a feature

specification is linked to separate segments, then the featural gesture must carry on uninterrupted between each of those segments to which it is linked.⁹

In describing the gapped configuration as universally ill-formed, I mean that it represents a structural configuration that may never be violated in the candidate set: it is not a structure that Gen is capable of producing (following Ní Chiosáin and Padgett 1997, see also Gafos 1996 for a similar result in the model of 'Articulatory Locality'). Ní Chiosáin and Padgett characterize the ill-formedness of gapping in terms of its failure to be *convex*. Their definition of a convex featural event is given in (24) (1997: 4; adapted from the definition of convex phonological event by Bird and Klein 1990).

(24) A featural event F is convex iff it satisfies the following condition:

For all segments, α , β , γ , if α precedes β , β precedes γ , α overlaps F and γ overlaps F, then β overlaps F.

As Ní Chiosáin and Padgett suggest, it is reasonable to assume that convexity holds of phonological representations without exception.¹⁰ The ill-formedness of the gapped configuration in (23) may thus be understood in these terms: the gapped configuration is not a possible phonological representation because it is not a convex featural event.

The consequence of segmentally strict locality for the analysis of nasal harmony is this: spreading of [+nasal] may never skip a segment by linking across it. If nasalization of a particular segment is not possible because of nasalization markedness constraints outranking spreading, the only outcome that may occur is that the segment block spreading.

⁹ An alternative approach adopting a violable notion of gapping is considered and rejected in chapter 5.

¹⁰ Archangeli and Pulleyblank (1994: 38) also argue that the gapped configuration can be ruled out on a formal basis in terms of precedence: however, they relativize this to skipping of anchors. Thus if spreading were to target moras (as they suggest for vowel harmony), non-moraic segments may be skipped.

2.2.2 A factorial ranking typology

Prince and Smolensky (1993) hypothesize that typologies are derived by factorial constraint ranking, that is, the set of possible languages will be given by the grammars produced by all of the different possible constraint rankings. The previous section established two kinds of constraints: the spreading imperative and the nasalized segment constraints. Under the factorial ranking hypothesis then, a typology should be derived by all of the possible rankings of these constraints. It has been determined that the nasalized segment constraints are intrinsically-ranked with respect to each other. This leaves all of the different rankings of the spreading constraint in relation to the nasal markedness hierarchy.

The complete set of possible rankings are given in (25). These rankings match perfectly with the hierarchical variation observed in the sets of undergoing and blocking segments in nasal harmony (in (12)). Because of the locality condition, [+nasal] can never skip associating to a segment in the attempt to achieve nasal spreading. Since skipping segments is not an option in spreading, any nasalized segment constraints which dominate spreading will produce blocking effects, as it would be worse to form these nasalized segments than violate spreading. In contrast, nasalized segment constraints outranked by spreading will correspond to participating segments, as it is better to violate these constraints by forming the nasalized segments, than it is to violate spreading instead.

(25) Hierarchical variation through constraint ranking:

① *Spanish:*

*NASOBSSTOP » *NASFRIC » *NASLIQUID » *NASGLIDE » *NASV » SPREAD[+nas]

② *Sundanese:*

*NASOBSSTOP » *NASFRIC » *NASLIQUID » *NASGLIDE » SPREAD[+nas] » *NASV

③ *Malay (Johore):*

*NASOBSSTOP » *NASFRIC » *NASLIQUID » **SPREAD[+nas]** » *NASGLIDE » *NASV

④ *Ijo (Kolokuma):*

*NASOBSSTOP » *NASFRIC » **SPREAD[+nas]** » *NASLIQUID » *NASGLIDE » *NASV

⑤ *Scottish Gaelic (Applecross):*

*NASOBSSTOP » **SPREAD[+nas]** » *NASFRIC » *NASLIQUID » *NASGLIDE » *NASV

⑥ *Tuyuca:*

SPREAD[+nas] » *NASOBSSTOP » *NASFRIC » *NASLIQUID » *NASGLIDE » *NASV

For case ① (Spanish), which exhibits no nasal harmony, SPREAD[+nas] is ranked below all nasalization constraints, as it fails to force violations of any of these constraints. For ② (Sundanese), where only vowels undergo nasal harmony, SPREAD[+nas] dominates just the constraint against nasalized vowels; other nasalization constraints are ranked above SPREAD[+nas], since they remain unviolated. ③ (Malay) maintains the same ranking of the nasalization constraints with respect to each other but moves SPREAD[+nas] over the nasalized glide constraint as well. ④ (Ijo) moves SPREAD[+nas] up one more to dominate the constraint against nasalized liquids, and for ⑤ (Applecross Gaelic) SPREAD[+nas] moves one more again so that fricatives also undergo. Finally for ⑥ (Tuyuca), SPREAD[+nas] dominates all nasalization constraints, giving a pattern in which all segments undergo harmony. The *NASSONSTOP constraint is not shown here, because all of the underlying sonorant stops are already nasal, so this constraint will not conflict with satisfaction of SPREAD[+nas].

The overall ranking that has been established for the typology of nasal harmony is given in (26). A crucial feature of this pattern is that the ranking of nasalization constraints

with respect to each other remains constant according to the intrinsically-ranked hierarchy in (14).

(26) Summary of constraint ranking:

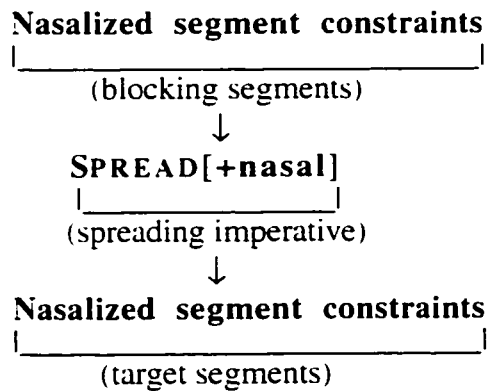

The ranking pattern is exemplified in (27-29). The tableau in (27) illustrates the pattern for Sundanese, with rightward spreading.¹¹ In this variation, only vowels undergo harmony, so the spreading constraint dominates the nasalized segment constraints only up to the constraint against nasalized vowels. The other nasalization constraints dominate spreading. Nasalization in candidates is marked with a tilde and brackets are used to delimit spans of an occurrence of a [+nasal] feature, i.e. [nã] implies that one nasal feature is linked to two segments and [n][ã] signifies that there is a separate nasal specification for each segment. In the optimal output, in (a), spreading extends only as far as the adjacent vowel, since extending any farther would violate a high-ranking nasalization constraint. In (b), [+nasal] links to every segment, satisfying spreading; however, this candidate loses, because it violates the higher-ranked constraints against nasalized glides and obstruents. Candidate (c) shows a similar problem in spreading up to the obstruent stop. Candidate (d)

¹¹ The following tableaux show the evaluation of candidates for a plausible input form. The input that corresponds to the actual underlying representation is determined by Lexicon Optimization discussed in section 1.3.3.

nasalizes every vowel in the word, but it fails on the basis of spreading because it does not derive nasalization of the second vowel by multiple-linking. In (e), no spreading takes place, and this too loses on an extra spreading violation.

(27) Sundanese

	ŋajak	*NAS OBSSTOP	*NAS FRIC	*NAS LIQ	*NAS GL	SPREAD-R ([+nas], Pwd)	*NAS V	*NAS SONSTOP
☞	a. [ŋā]jak					***	*	*
	b. [ŋājāk̄]	*!			*		**	*
	c. [ŋājā]k				*!		**	*
	d. [ŋā]j[ā]k					****!	**	*
	e. [ŋ]ajak					****!		*

The variations in nasal harmony will differ from Sundanese only in the ranking of the spreading constraint. (28) illustrates the case of Ijo, where vowels, glides, and liquids undergo nasalization. For this pattern, a leftward spreading constraint is situated between the constraint against nasalized fricatives and the constraint against nasalized liquids.

(28) Ijo

	sɔrɔ̃	*NAS OBSSTOP	*NAS FRIC	SPREAD-L ([+nas], Pwd)	*NAS LIQ	*NAS GL	*NAS V	*NAS SONSTOP
☞	a. s[ɔ̃rɔ̃]			*	*		**	
	b. [s̃ɔ̃rɔ̃]		*!		*		**	
	c. sɔr[ɔ̃]			**!*			*	

When the spreading constraint dominates all of the nasalized segment constraints, all segments will participate in nasal harmony. This is how I propose to treat Tuyuca:

(29) Tuyuca

	wāti	SPREAD ([+nas], M)	*NAS OBSSTOP	*NAS FRIC	*NAS LIQ	*NAS GL	*NAS V	*NAS SONSTOP
☞	a. [wā̃tī̃]		*			*	**	
	b. [wā]ti	*!*				*	*	
	c. w[ā̃]ti	*!***					*	
	d. [wā̃]t[ī̃]	*!****				*	**	

The optimal output selected on the basis of this ranking is the one in (a), in which all segments are nasalized, including the voiceless obstruent stop. This segment is described as oral, corresponding to a representation like that in (d), with a separate nasal feature on either side of the stop. However, since candidate (d) incurs a superset of the spreading and markedness constraint violations that (b) does, where the stop blocks spreading, (d) can never be optimal under any ranking of these constraints. A candidate like (a), with spreading to all segments, is the only one for which spreading can drive nasalization of the vowel following the stop. A grammar with this outcome is predicted by the factorial ranking hypothesis. Accordingly, I posit this as the basic analysis for languages with transparent segments in nasal harmony, and in chapter 3 I explore how the optimal candidate in (a) is mapped to the outcome in (d) in an opaque constraint interaction.

We have now seen that factorial constraint ranking of the spreading constraint in relation to the hierarchy of nasalized segment constraints derives precisely the hierarchical variation observed across languages. A claim underlying this typology is that descriptively transparent segments should be regarded as undergoing nasal spreading themselves, which has a more general grounding in the claim that spreading is segmentally strictly local. The analysis of 'transparent' segments as undergoers is supported by the observations of cross-linguistic variation on three fronts. First, the class of segments which may behave transparent are basically in complementary distribution with those that may become

nasalized in nasal harmony. Second, a system in which all segments, including obstruents, undergo nasalization is predicted under the factorial ranking hypothesis: positing transparent segments as undergoers fills this slot given by the hierarchy. Third, this analysis explains the generalization that whenever a segment behaves transparent to nasal spreading, all segments more compatible with nasalization undergo spreading. As noted earlier, there is also external evidence for strict locality from the work of researchers on other spreading phenomena. Chapter 3 focuses on a means of deriving the surface orality of ‘transparent’ segments while maintaining the assumption of strict locality. There it is demonstrated that transparent segments can be captured under the ‘sympathy’ approach to opaque constraint interaction (McCarthy 1997, with developments by Itô and Mester 1997a, b), a mechanism with independent motivation in the theory.

2.2.3 The status of ‘transparent’ glottals

A brief word about the status of glottals (e.g. [h, ʔ]) in nasal harmony is required. In the transcription of these segments within nasal harmony spans, I have marked them as nasalized. Interpreting the articulatory correlate of [+nasal] as a lowered velum and not necessarily nasal airflow (Howard 1973; Cohn 1993a; Walker and Pullum 1997), the phonetic nasalization of glottal segments within nasal spans is uncontroversial (Howard 1973; Cohn 1990, 1993a; Ohala 1990; Durie 1985; Ladefoged and Maddieson 1996; Walker and Pullum 1997). Yet the phonological nasalization of these segments has been called into question by Cohn (1990, 1993a). Walker and Pullum (1997), on the other hand, argue that glottals can be nasalized in the phonology of a language.

Working in a feature-geometric framework, Cohn tentatively suggests that the feature [nasal] is not phonologically relevant for glottal segments. To implement this proposal, she proposes that [nasal] is a dependent of the supralaryngeal node in segment

structure, a node that is absent in glottals and present in all supralaryngeal segments, as illustrated in (30) (from Cohn 1993a: 349).

(30) Feature-geometric structure with [nasal] dependent on Supralaryngeal node

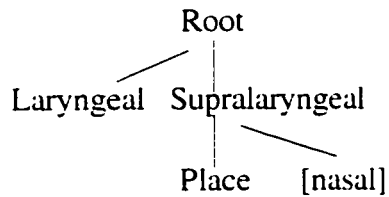

With this model of segmental structure, spreading of [+nasal] will target only supralaryngeal segments (i.e. those with a supralaryngeal node), and glottal segments will be skipped. The locality assumed here, where adjacency is relativized to tiers, is standard for feature-geometric accounts. Under this view, gapping of [+nasal] feature linkage is allowed across a glottal segment provided the feature is associated to adjacent supralaryngeal nodes. Cohn's proposal achieves the outcome that glottals will not block nasal spreading, as is generally true of nasal harmony patterns (although a few languages with blocking by glottals are discussed in section 2.4). To produce the phonetic nasalization of glottal segments in nasal harmony spans, she draws on a separate level of phonetic implementation.

Walker and Pullum (1997) argue for a different view in which glottal segments can be nasalized in phonological representations. Walker and Pullum note that strong evidence for the possibility of phonologically nasalized glottals is provided by instances of languages with a phonemic nasal glottal continuant ([\tilde{h}] in Kwangali, Arabela).¹² Further support comes from the finding that nasal spreading is strictly local, as noted by Walker (1996) and

¹² On the possibility of a phonemic nasal glottal stop see Walker and Pullum (1997); Ní Chiosáin and Padgett (1997) also provide insightful discussion on this issue.

argued for in this chapter. The skipping approach suggested by Cohn would seem to undermine this claim concerning locality; however, Walker and Pullum observe that there is no reason to posit glottals as skipped. The existence of phonemic nasal glottals shows that [nasal] must be allowed in the phonological representation of the class of glottal segments, and consequently, they neither can nor should be excluded from the set of possible targets of nasalization. The present account does not seek to achieve explanation through feature-geometric structures, the representational assumptions are rather that [nasal] may be linked to any segment: skipping is not an option, and if a segment fails to be permeated in nasal spreading, its only alternative is to block, as driven by feature cooccurrence constraints. We may thus conclude that glottal segments fully participate in nasal spreading in languages where they do not block. The cross-linguistic patterning of glottals in nasal harmony is discussed in the review of the database findings in section 2.4. There it is noted that glottal segments are typically grouped with the vocoids in terms of their compatibility with nasalization; however, their blocking behavior in a few languages suggests that in some cases they may be phonologically classified as obstruents. The role of perceptibility of nasalization in some instances of glottal blocking is also discussed.

Finally, it is worth pointing out that glottal stops in nasal harmony provide an interesting example where a segment undergoes nasal spreading even though there is no perceptual cue to the nasalization on the segment itself. In this case, the absence of perceptible nasalization does not mean that [+nasal] has failed to be realized during the segment: the property of having a lowered velum simply has no acoustic effect when there is a complete closure at the glottis. This kind of transparency is thus one where carrying a feature through a segment has no acoustic consequences, although the spreading feature is highly compatible from an articulatory perspective with the target segment. This kind of *false* transparency can be distinguished from cases of *true* transparency, where a segment

that is highly incompatible with a spreading feature behaves transparent, i.e. the case of transparent obstruents in nasal harmony. These different kinds of transparency will be discussed further in chapter 3.

2.3 Interaction of the hierarchy with multiple constraints

In section 2.2.2, cross-linguistic evidence for the nasalization constraint hierarchy was presented. It was demonstrated that the nasal spreading constraint could occur ranked at different points in the hierarchy in different languages. The fixed ranking of the constraints in the nasalization hierarchy also makes the prediction that different constraints may be ranked at separate points in the hierarchy in the same language. I will now briefly examine two such cases.

The first example is found in Epena Pedee, a Choco language spoken in Colombia described by Harms (1985, 1994). Epena Pedee has two separate nasal harmony phenomena. It exhibits a rightward spreading triggered by a nasal vowel. This rightward spreading nasalizes vowels, glottals, glides, and liquids. It is blocked by voiced and voiceless stops, fricatives, and the trill. In addition to this rightward spreading, there is a regressive nasal spreading within the syllable that nasalizes the onset to a nasal vowel (all syllables in Epena Pedee are open). This produces nasalization of all segments except voiceless stops. Voiced stops in onsets nasalize to become fully nasal stops. Harms points out that Epena Pedee has three distinctive series of stops: voiced, voiceless unaspirated, and voiceless aspirated. Voiced oral and nasal stops both occur in the outputs of the languages but in a non-contrastive distribution: nasal stops occur only in the onset to a nasal vowel and voiced oral stops occur elsewhere. The nasal spreading is illustrated in (31). Note that obstruents at the edge of a nasal span are prenasalized. Underlying forms shown here follow Harms (1985).

(31) Epena Pedee

a.	/perōra/	[peṛōṛā]	‘guagua (a groundhog-like animal)’
b.	/ūbuisi/	[ʔū ^m buisi]	‘neck’
c.	/bēdewe/	[mē ⁿ dewe]	‘blind snake’
d.	/wāhida/	[wā ^h ī ⁿ da]	‘they went’ (go+past+plural)
e.	/k ^h isia/	[k ^h ī ⁿ siə]	‘think’
f.	/hōp ^h e/	[hō ^m p ^h e]	‘a species of fish’
g.	/wāit ^h ee/	[wā ⁱ ī ⁿ t ^h ee]	‘go’ (future)
h.	/dāwe/	[nāwē]	‘mother’
i.	/bībīajaa/	[mīmīānāā]	‘work a lot’
j.	/k ^h uruidā/	[k ^h ur ^u nā]	‘eel’
k.	/hebēdē/	[hemēnē]	‘to play’
l.	/hēsaā/	[hēsāā]	‘stinging ant’

Interestingly, the two nasal harmony phenomena of Epena Pedee differ in their degree of strength. The rightward nasal spreading nasalizes sonorants but is blocked by obstruents, while the (leftward) nasalization within the syllable nasalizes sonorants and obstruents. This indicates that two nasal spreading constraints are active in Epena Pedee, one demanding nasalization within the domain of the syllable, and the other requiring rightward spreading in the word. To realize their different strengths, these constraints will be ranked at separate points in the nasalization hierarchy. The syllable spreading constraint must outrank all nasalization constraints, while the rightward nasal spreading constraint will be dominated by constraints against nasalized obstruents. The outcome is illustrated in (32-33).

(32) Blocking of right spreading by an obstruent

wahida	SPREAD ([+n], σ)	*NAS OBSST	*NAS FR	SPREAD-R ([+n], Pwd)	*NAS LIQ	*NAS GL	*NAS V	*NAS SONST
a. [wāhī̃]da				**		*	**	
b. [wāhī̃dā]		*!				*	***	
c. [wā]hida				***!*		*	*	
d. w[ā]hida	*!			****			*	

(33) Nasalization of an obstruent in syllable-domain spreading

hēsaā	SPREAD ([+n], σ)	*NAS OBSST	*NAS FR	SPREAD-R ([+n], Pwd)	*NAS LIQ	*NAS GL	*NAS V	*NAS SONST
a. [hē̃saā]			*				***	
b. [hē̃s]s[āā]	*!						***	
c. h[ē̃]s[āā]	*!*						***	

The second example of constraints ranked at separate points in relation to the nasalization hierarchy comes from Ijo (Williamson 1965, 1969b, 1987). The nasal harmony pattern of Ijo was discussed in section 2.1: a nasal stop or nasal vowel triggers leftward spread through vowels, glides, and liquids; obstruents block nasal spreading. We have established that this spreading pattern comes about by ranking a leftward nasal spreading constraint between *NASFRICATIVE and *NASLIQUID in the nasalization hierarchy. Another break in the hierarchy is needed to obtain nasality as a phonemic property of nasal stops and vowels. This is achieved by ranking IDENT-IO[+nasal] over *NASVOWEL and *NASSONSTOP (see section 1.3.3 for background on this approach). This produces an outcome in which only vowels and nasal stops may trigger nasal spreading. An example of nasalization triggered by a nasal vowel is shown in (34). After McCarthy and Prince (1995: 280), I use F*[nas] to indicate the class of constraints that

dispose of other possible ways of satisfying nasal spreading, for example through deletion or denasalization of the nasal trigger segment.¹³

(34) Nasal vowel triggers in Ijo

	sɔrɔ̃	*NAS OBSST	*NAS FR	F' [nas]	SPREAD-L ([+n], Pwd)	*NAS LIQ	*NAS GL	ID-IO [+nas]	*NAS V	*NAS SONST
☞	a. s[ɔ̃rɔ̃]				*	*			**	
	b. [sɔ̃rɔ̃]		*!			*			**	
	c. sɔr[ɔ̃]				**!*				*	
	d. sɔrɔ			*!				*		

The tableau in (35) shows the operation of the constraint hierarchy on an input with a nasalized liquid. Here, the ranking of IDENT-IO[+nasal] below *NASLIQUID will cause the liquid to surface as oral.

(35) No 'phonemic' nasal liquids in Ijo

	ɾa	*NAS OBSST	*NAS FR	F' [nas]	SPREAD-L ([+n], Pwd)	*NAS LIQ	*NAS GL	ID-IO [+nas]	*NAS V	*NAS SONST
☞	a. ɾa					*!				
	b. ra							*		

More generally on the subject of inventories, the nasalization hierarchy predicts that inventories will exhibit the same kinds of implications as spreading, that is, if a nasalized segment occurs in the inventory of a language, all more compatible segments will also have nasal counterparts in the inventory and if a segment has no nasal counterpart in an inventory, all less compatible segments will also occur only oral in the inventory. This

¹³ Given that spreading outranks IDENT-IO[+nasal], I assume here that denasalization of the nasal trigger must always violate something other than just IDENT-IO[+nasal]. This is part of a general question of why spreading can never be satisfied by simply deleting the feature to be spread. The matter is one that I will leave for further research.

may be modulated, however, by the demands of contrast (as will be discussed in 2.4). For the most part, inventories of the languages of the world bear out this prediction (see discussion in Pulleyblank 1989; Cohn 1993a; Ferguson 1963, 1975 provides foundation). Almost every language of the world has nasal stops as part of its inventory (97%; UPSID; Maddieson 1984). Distinctively nasal vowels occur considerably less frequently (in less than 25% of the languages in UPSID). Nasalized continuant consonants are contrastive in the inventories of languages only rarely. In those inventories with nasalized continuants, it is generally the case that the implications given by the nasalization hierarchy holds. The implication that the presence of nasal vowels will imply nasal stops was first noted by Ferguson (1963). Ijo provides an example of a language which has distinctively nasalized vowels in its inventory as well as nasal stops.¹⁴ UMBundu, a Benue-Congo language of Angola, is a more extreme case. UMBundu is noted by Schadeberg (1982) to have a contrastively nasalized voiced fricative /ṽ/. In addition to this, the inventory of this language has nasal stops, nasal vowels, a nasal glottal, nasal glide, and nasal liquid.¹⁵ In a survey of the status of nasalized continuants, Cohn (1993a) notes that the languages with nasalized continuant consonants (including nasalized glides) do not always have nasal vowels. Cohn points out that some of these nasalized segments emerge through historical or synchronic weakening of other nasalized segments, such as palatal or velar nasals, recalling patterns discussed by Trigo (1988). This is a promising direction for pursuing an understanding of inventory asymmetries in the case of nasalized continuant consonants.

¹⁴ For several Amazonian languages, it has been observed by various researchers that a phonemic analysis of the language need only posit nasality as 'underlying' on vowels. However, all of these languages still admit nasal stops in the output inventory, and it appears that only economy of phonemes excludes nasal stops from the 'underlying' inventory (as argued for Tuyuca, voiced obstruent stops must be included in the inventory). This issue becomes less important in the view of inventories under OT, as will be seen in chapter 3.

¹⁵ This concept of the UMBundu inventory is that proposed by Schadeberg (1982). Cohn (1993a: 332) suggests an alternative interpretation in which nasality is a lexical property of the last syllable of the stem and nasalized continuants are derived.

2.4 Appendix: The nasal harmony database

2.4.1 Summary and discussion

In this section I present a condensed version of the database of nasal harmony patterns. This database contains entries for over 75 languages. An important result of this comprehensive survey is that it shows that cross-linguistic variation obeys the hierarchical typology of nasal harmony in (12). There also proves to be some interesting variability in the ranking of glottals and voiced stops versus voiceless fricatives, which is discussed below.

The database assembles substantial information about each language, including the language name, family, and location, the inventory of segments, the segments triggering nasal spread, blocking segments, descriptively transparent segments, nasalizable segments, prosodic conditions on blocking or triggering segments, direction of spreading, domain of spreading, occurrence of prenasalization, whether nasalization functions as a morpheme, references, and any further related facts. A condensed version of the database is appended at the end of this section. Information included in these entries is as follows (organized by columns in data presentation):

1. Language: Language name, dialect, language family, and where spoken.
2. Triggers: Segments initiating nasal spreading.
3. Through: Segments propagating nasalization, i.e. those that are nasalized or descriptively transparent.
4. Direction: Direction of nasal spreading.
5. Comments: Details related to nasal harmony in the language.
6. Selected references.

Nasal spreading patterns included here are those in which nasality spreads across syllables or nasalization targets nonvocalic segments in the syllable.¹⁶ The information is based on my own examination of primary source descriptions (wherever possible). In addition, three secondary sources provided significant foundational background to this research. These are Cohn's (1993c) survey of the status of the feature [+nasal] across a wide range of languages and the surveys of nasal spreading reported in Schourup (1972, 1973) and Piggott (1992). Other important secondary sources include Court (1970), papers in Ferguson, Hyman, and Ohala, eds., (1975), Anderson (1976), Hart (1981), van der Hulst and Smith (1982), Beddor (1983), Bivin (1986), Kawasaki (1986), Pulleyblank (1989), and papers in Huffman and Krakow, eds., (1993).

The central finding of the survey is that variation in nasal harmony across languages verifies the implicational hierarchy outlined in section 2.1. The study finds that if a segment blocks nasalization, all segments less compatible by the nasalization hierarchy will also block nasal spreading, and if a segment undergoes nasalization or behaves transparent, all segments more compatible with nasality will undergo nasal spreading. Transparency effects are limited to the class of obstruents, that is, only obstruents have ever been shown to surface as oral within a nasal harmony span; other segments become nasalized in this context. Obstruents are also the class for which there is no example of nasalization of all segments. Filling this gap motivates the claim that transparent segments should be understood as targets of nasal spreading, so that a language with nasalization of all segments except some transparent obstruents actually corresponds to a language in which all segments undergo nasal harmony. We thereby derive a complete typology in which all variants are attested.

¹⁶ A long-distance nasalization pattern occurring in certain Bantu languages (Ao 1991, Odden 1994, Hyman 1995, Piggott 1996) is discussed in chapter 6. I argue that these alternations are examples of cooccurrence effects, not nasal spreading.

The implicational hierarchy defined five basic patterns of nasalization, corresponding to each step in the hierarchy of segmental classes (excluding patterns in which no segments undergo nasal spreading). A summary of the languages in the database corresponding to each of these variants is given in (36) below with shaded portions of the hierarchy identifying classes of segments which block nasal spread. Portions of the hierarchy which are not shaded identify classes of segments which nasalization spreads through. These segments either become nasalized or behave transparent. Note that the glottals category has been added here between the classes of vowels and glides. In the majority of languages in which vocoids undergo nasalization, glottals do not inhibit nasal spreading. However, the glottals category is enclosed in parentheses because some descriptions are not explicit on the behavior of glottals in nasal harmony, and there is at least one instance in which glottals block when glides undergo. This signals some variability in the cross-linguistic compatibility of glottals with nasalization.

(36) Summary of languages in the five main patterns of nasal harmony

i. Vowels (Glottals) Glides Liquids Fricatives Obstruent stops

9 examples in database:

Language	Dialect	Family	Location
Barasano	Northern	Tucanoan	Colombia
Guahibo		Guahibo-Pamaguan	Colombia, Brazil
Mixtec	Ayutla	Mixtecan	Mexico
Mixtec	Mixtepec	Mixtecan	Mexico
Mixtec	Molinos	Mixtecan	Mexico
Mixtec	Silacayoapan	Mixtecan	Mexico

Otomi	Pame	Otopamean	Mexico
Sundanese		Hesperonesian	Indonesia
Tinrin		Melanesian	

ii. Vowels (Glottals) Glides Liquids Fricatives Obstruent stops

28 examples in database:

Language	Dialect	Family	Location
Acehnese		Hesperonesian	Indonesia
Aguaruna		Jivaroan	Peru
Arabela		Zaparoan	Peru
Bariba		Voltaic	Nigeria
Breton		Celtic	France
Capanahua		Panoan	Peru
Chinantec	Tepetotutla	Chinantecan	Mexico
Dayak	Kendayan	Indonesian	Borneo
Dayak	Land, Bukar Sadong	Hesperonesian	Indonesia
Dayak	Land, Měntu	Indonesian	Sarawak
Dayak	Sea	Indonesian	Sarawak
Konkani		Indo-Iranian	India
Lamani		Indo-Aryan	India
Madurese		Malayo-Polynesian	Indonesia
Malay	Johore	Indonesian	Malaysia
Malay	Ulu Muar	Indonesian	Malaysia
Marathi		Indo-Aryan	India
Maxakali		(isolate)	Brazil

Melanau	Mukah	Austronesian	Sarawak
Orejon	(after Velie & Velie)	Tucanoan	Peru
Oriya	Colloquial variety	Indo-Aryan	India
Rejang		Austronesian	South Sumatra
Saramaccan		(creole)	Surinam
Seneca		Iroquoian	Canada, USA
Terena/o		Arawakan	Brazil
Warao		(isolate)	Venezuela, Guyana
Urak Lawoi'		Hesperonesian	Thailand, Malaysia
Urdu		Indo-Iranian	Pakistan, India

iii. Vowels (Glottals) Glides Liquids Fricatives Obstruent stops

15 examples in database:

Language	Dialect	Family	Location
Edo		Kwa	Nigeria
English	Midwestern	Germanic	USA
Epena Pedee		Choco	Colombia (R spreading)
Epera		Choco	Panama (cross-morph.)
Ewe/Gbe		Kwa	Ghana, Togo, Bénin, Nigeria
Hindi		Indo-Iranian	India, Pakistan
Ijo	Kolokuma	Kwa	Nigeria
Isoko	Ozoro	Kwa	Nigeria
Kayan	Uma Juman	Austronesian	Sarawak
Kpelle		Mande	Liberia, Guinea
Mandan		Siouan	USA

Tucano	Tucanoan	Colombia (cross-morph.)
Tuyuca	Tucanoan	Colombia. Brazil (cross-mor.)
Urhobo	Kwa	Nigeria
Yoruba	Kwa	Nigeria

iv. Vowels (Glottals) Glides Liquids Fricatives Obstruent stops

4 examples in database:

Language	Dialect	Family	Location
Ennemor		Semitic	Ethiopia
Itsekeri		Kwa	Nigeria
Scottish Gaelic	Applecross	Celtic	Scotland
UMbundu		Benue-Congo	Angola

v. Vowels (Glottals) Glides Liquids Fricatives Obstruent stops

29 examples in database:

Language	Dialect	Family	Location
Apinayé		Ge	Brazil
Barasano	Northern	Tucanoan	Colombia (L spreading)
Barasano	Southern	Tucanoan	Colombia
Bribri		Chibchan	Costa Rica
Cabécar	Southern	Chibchan	
Cabécar	Northern	Chibchan	
Cayuvava			Bolivia
Cubeo		Tucanoan	Colombia

Desano		Tucanoan	Colombia, Brazil
Epena Pedee		Choco	Colombia (L spreading)
Epera		Choco	Panama (domain: morph.)
Gbeya		Adamawa-Eastern	Central African Republic
Gokana		Benue-Congo	Nigeria
Guanano		Tucanoan	Colombia
Guaraní		Tupí	Paraguay, Brazil, Colombia
Guaymi			Panama
Igbo	Ohuhu	Igbo	Nigeria
Icua Tupí		Tupí-Guaraní	Brazil
Kaiwá		Tupí-Guaraní	Brazil
Mixtec	Atatlahuca	Mixtecan	Mexico
Mixtec	Coatzospan	Mixtecan	Mexico
Mixtec	Ocotepec	Mixtecan	Mexico
Orejon	(after Armaiz)	Tucanoan	Peru
Parintintin		Tupí-Guaraní	Brazil
Shiriana		Shirianian	Venezuela, Brazil
Siriano		Tucanoan	Colombia, Brazil
Tatuyo		Tucanoan	Colombia
Tucano		Tucanoan	Colombia (domain: morph.)
Tuyuca		Tucanoan	Colombia, Brazil (dom: mor.)

The above summary shows that all of the cases of nasal harmony examined can be classified according to the hierarchical typology. It also indicates that some patterns are more widespread than others. Nasalization of vocoids (and glottals) is one of the most common patterns, with concentrations of languages in the Pacific (Austronesian family).

India (Indo-Iranian family), and Central and South America. A second common pattern spreads nasalization through all classes of segments. This pattern is frequent in the indigenous languages of South and Central America, especially in the Tucanoan and Tupí-Guaraní branches of the Amazonian language family. Nasalization of just the class of sonorants is somewhat less common but is nevertheless well-attested in the Kwa languages of Nigeria and in the cross-morpheme spreading pattern of some South/Central American languages, as well as in a scattering of other languages. The category with the least members is the one in which nasalization spreads through sonorants and fricatives but is blocked by obstruent stops. This suggests that if the demand of nasal harmony is strong enough to spread through fricatives, it generally is strong enough to target stops as well.

The reports of nasalized fricatives deserve some comment. The data in (6) showed nasalization of voiced and voiceless fricatives in the Applecross dialect of Scottish Gaelic, following Ternes's own reports on the basis of contact with Gaelic speakers. In a survey of occurrences of nasalized continuants, Cohn (1993a) cites three other languages reported to have nasalized fricatives: Waffa (Papuan, Papua New Guinea; Stringer and Hotz 1973), UMBundu (Niger-Kordofanian, Angola; Schadeberg 1982) and Igbo (Niger-Kordofanian, Nigeria; Green and Igwe 1963). Some other examples we may add include Epena Pedee (Harms 1985), Ennemor (Hetzron and Marcos 1966), and Icelandic (Pétursson 1973 and Einarsson 1940 cited by Padgett 1995c: 51 n. 32). Yet Ohala and Ohala (1993) have questioned the possibility of nasalizing fricatives articulated forward of the velum. They suggest that it is impossible for such sounds to be produced with a lowered velum, because the open nasal airway will prevent the build-up of air pressure in the oral cavity needed to produce the characteristic fricative turbulence (1993: 227-8; see also J. Ohala 1975 for this claim concerning voiced fricatives). Certainly, there is a tendency for so-called 'voiced fricatives' to be produced as frictionless continuants under nasalization (Ohala 1983; Pickett 1980). However, there is good support for the occurrence of nasalized fricatives in some

languages. Descriptions of Epena Pedee and Icelandic are explicit in claiming that nasal airflow is maintained during the fricative. Ladefoged and Maddieson's review of the topic finds that 'there is good evidence that a nasalized fricative occurs in UMBundu' (1996: 134). This segment is described by Schadeberg as a 'voiced nasalized labial continuant,' transcribed as [ṽ], and after explicitly remarking on Ohala's claim that such segments are impossible. Schadeberg notes that this segment contrasts with a nasalized labial approximant [w̃] (1982: 127). Evidence for a voiceless nasalized fricative comes from Gerfen's (1996) instrumental investigation of Coatzospan Mixtec (Mixtecan, Mexico), where he finds that nasal airflow persists through a so-called 'transparent' voiceless coronal fricative [ʃ]. It should be noted that while Gerfen's results are strongly suggestive that it is possible to produce a voiceless fricative with a lowered velum, his technique gauged velum position indirectly through airflow measurements. For absolute certainty on this issue, a direct measurement of velum position is needed.

Recent work by Ohala, Solé, and Ying (1998) investigated the matter of nasalized fricatives by creating a pseudo-velopharyngeal valve. They created the valve by inserting catheters of various sizes into the oral cavity (via the buccal sulcus and the gap behind the upper molars) and intermittently opening and closing the outer openings. Catheters of different sizes simulated differences in velo-pharyngeal opening; although as Ohala, Solé, and Ying note, the size of catheter aperture may not correspond precisely to the impedance produced by the same velo-pharyngeal opening, because the length of the catheters was greater than the length of the nasal passage. They discovered that for the smallest catheter, 7.9 mm², there was no significant effect on the level of pharyngeal pressure (i.e. pressure behind the constriction for the buccal fricative) and no detectable effect on the quality of the fricative. For catheters with areas of 17.9 mm² and above they found that pharyngeal pressure dropped considerably, especially for voiced fricatives. The pressure drop was

weaker in voiceless fricatives because the open glottis in these segments allowed greater airflow up from the lungs to combat a drop in pressure. Because of the pressure drop from the catheter, voiced fricatives became frictionless continuants and aperiodic acoustic energy was reduced in voiceless fricatives in the higher frequencies. The findings of this study clearly support that claim that nasalization is antagonistic to fricative sounds; however, this antagonism appears gradient such that the greater the velo-pharyngeal aperture, the greater the reduction in friction, and conversely, the smaller the velo-pharyngeal aperture, the less perceptible the nasalization. Balancing this gradient with the findings of various researchers supporting the existence of nasalized fricatives, I assume that they do occur in some languages, although typically either degree of friction or perceptibility of nasalization will suffer in the production of these segments.

Examination of the languages in which nasalization spreads through some obstruents suggests that there is cross-linguistic variability in the ranking of voiceless fricatives and voiced stops in the nasalization hierarchy. In the class of obstruents it is always the case that voiced fricatives are the most compatible with nasalization and voiceless stops are the least compatible. Continuancy and voicing thus are qualities favoring nasalization of obstruents. For segments with just one of these qualities, languages appear to vary in whether continuancy or voicing is more compatible with nasalization. This is illustrated by comparison of the patterns in (37).

(37) Cross-linguistic variation in nasalization of obstruents

Through		Blocking		
Vcd. fricatives	Vcls. fricatives	Vcd. stops	Vcls. stops	<i>e.g. Itsekeri, Ennemor</i>
Vcd. fricatives	Vcls. fricatives	Vcd. stops	Vcls. stops	<i>e.g. Scottish Gaelic (Applecross)</i>
Vcd. fricatives	Vcd. stops	Vcls. fricatives	Vcls. stops	<i>e.g. Epera, Orejon, Parintintin</i>
Vcd. fricatives	Vcls. fricatives	Vcd. stops	Vcls. stops	<i>e.g. Tuyuca, Tucano, Barasano.</i>

So far the hierarchy has segregated obstruents according to their continuancy, but the nasalization pattern in languages such as Epera, Orejon (dialect described by Arnaiz), and Parintintin indicates that separation by voicing is also a useful segregation. For languages such as these, the lower end of the compatibility hierarchy can be modified to rank voiced obstruents over voiceless ones. This mirrors variability across languages in the ranking of these classes of segments in the sonority hierarchy (cf. Hooper 1972, 1976 versus Steriade 1982). The source for parallels between the nasalization hierarchy and the sonority hierarchy was discussed in 2.2.1. Note that the occurrence of a pattern targetting just voiced fricatives (in Itsekeri and Ennemor) shows that languages may make finer-grained distinctions than those precisely matching the five major classes of segments. The five-way classification is thus useful for a general typology, but we might recognize that within these classes themselves, subclasses or even individual segments may be scaled according to their compatibility with nasalization.

Another cross-linguistic variability concerns the ranking of glottals in the implicational hierarchy. In the database we find that in the majority of nasal harmony patterns, nasalization spreads through any glottal segments in the language, i.e. the segments [h, ʔ] (although sometimes the behavior of glottals in nasalization is not discussed in the source). This tendency for glottals to undergo nasal spreading can be

explained in terms of the articulatory compatibility of these segments with nasalization, since producing these segments with a lowered velum does not in any way interfere with the glottal articulation (see Walker and Pullum 1997 and references therein; also discussion in 2.2.3; cf. Cohn 1993a). Further, as noted in discussion of the ‘rhinoglottophilia’ phenomenon (Matisoff 1975; J. Ohala 1975), the acoustic effect of a glottal continuant on a neighboring vowel can resemble that of a lowered velum, actually favoring the interpretation of vowels as nasal when adjacent to [h]. On the other hand, the patterning of glottal segments in some languages suggests that they can sometimes be phonologically classified as obstruents, i.e. as [-sonorant] segments that are incompatible with nasalization. A possible case of blocking by glottal fricatives occurs in Terena, an Arawakan language of Brazil. Terena marks first person forms with nasalization of a morpheme from left to right, and [h] and [hʲ] pattern with the obstruents in blocking nasal spread. Bendor-Samuel (1960: 349) analyzes these segments as true fricatives (rather than glides, for example), noting that [hʲ] is actually produced with an alveolar constriction and that both [h] and [hʲ] function phonologically in the same way as [s] and [ʃ].

For glottal stop, blocking occurs in the Austronesian language, Rejang, spoken in South Sumatra. McGinn (1979: 187) observes that glottal stop patterns with the obstruents in blocking the rightward spread of nasality from a nasal stop, e.g. [mãʔaʔ] ‘approach’: cf. [nĩjõwã] ‘coconut’. Harrison and Taylor (1971: 17) note that in Kaiwá, a Tupí-Guaraní language of Brazil, nasalization spreads through glottal stop in normal speech, but in slow speech [ʔ] blocks nasal spreading. It is also conceivable that the dispreference in some languages for a nasalized glottal stop has an acoustic/perceptual basis. Ní Chiosáin and Padgett (1997) have pointed out that nasalization of glottal stop is poor in achieving perceptible nasalization on the individual segment (see also discussion in Walker and Pullum 1997). The perceptibility problem is quite clear: because there is full stoppage of

air behind the velum at the glottis, there can be no nasal airflow during a glottal stop. Thus, even though glottal stop can be ‘nasalized’ by being produced with a lowered velum, there will be no acoustic cue during the stop itself to signal the nasalization. The above cases suggest that while glottals most commonly pattern with the vocoidal segments in terms of their tendency to undergo nasalization, other factors can come into play, such as the phonological classification of these segments with obstruents rather than glides or perhaps the perceptibility of nasalization.

The implicational hierarchy is a good predictor of the likelihood of segments to undergo nasalization, but the nasal harmony database finds that other factors can also contribute to patterns of nasalization. One such factor is the demand of maintaining perceptible contrasts. It is well-known that nasalization tends to obscure the perceptibility of vowel height contrasts, evidenced, for example, by the universal generalization that the number of nasal vowels in a language never exceeds the number of oral vowels (Ruhlen 1975; Beddor 1983; Wright 1986; Padgett 1997, among others). The demand to preserve vowel height contrasts can contribute to blocking effects in nasal spreading. An example of this occurs in the Applecross dialect of Scottish Gaelic. Scottish Gaelic has four vowel heights in its oral vowels (high, mid-high, mid-low, low) and three vowel heights in its nasal vowels (high, mid-low, low); thus, the oral mid-high vowels [e, ə, o] are missing phonemic nasal counterparts. This contrast-driven gap in the nasal vowel inventory is also apparent in nasal spreading: the oral mid-high vowels always block nasalization from an adjacent syllable, but vowels of other heights become nasalized. Here the demand to maintain perceptible vowel height contrasts outranks the demand of nasal spreading, producing blocking by a specific vowel height. More generally, in the very common phenomenon of nasalization of vowels by tautosyllabic nasal consonants, it is often the case that nasalization is restricted to certain vowel heights (see surveys in Schourup 1972,

1973; Beddor 1983). Further, degree of nasalization may sometimes vary with vowel height. In Yoruba, for example, progressive nasalization of vowels after a tautosyllabic nasal consonant is reported to produce heavy nasalization of high and low vowels, but light nasalization in the mid vowels [e, ε, o, ɔ] (Ward 1952: 13).¹⁷

Vowel backness also appears to interact with blocking in some cases. In Guaymi, spoken in Panama, the left-to-right nasalization which marks a near past completed action in class II verbs is blocked by back vowels but targets front vowels and voiced consonants (Bivin 1986 citing Kopesec and Kopesec 1975). In addition, Schourup (1973: 192) notes that vowel nasalization affects only front vowels in Sora (Munda; India; Schourup 1973 citing personal communication with Stampe) and Island Carib (Arawakan; Dominica; Taylor 1951). As a factor in perceptible degree of nasalization, Williamson (1965: 17) reports that in Ijo, back vowels are perceived as more nasalized than front ones (although kymograph records do not show a significant difference in the actual degree of nasalization in this environment). Yet Beddor (1993) notes that the acoustic consequences of nasalization for the perception of vowel backness is not entirely clear. Perhaps the strongest evidence for an interaction comes from Wright (1986), who found that nasalization caused front vowels to be perceived as more back than their oral counterparts. However, findings for the back vowels were less uniform with [ō] perceived as more front than [o] and high back nasal vowels perceived as slightly farther back than their oral versions. Wright's study suggests that nasalization may have some neutralizing effect on the perception of vowel backness. However, it is conceivable that the blocking behavior of back vowels could be another instance of the vowel height effect. Drawing on the findings of Hardcastle (1970) and K. Stevens (1968), Lindblom (1986) notes three sets of facts concerning a front/back asymmetry in the vocal tract: (i) articulators have increased mobility

¹⁷ [ɔ] is sometimes an exception to this generalization. Ward reports two words, [ɔmɔ] 'child' and [mɔ] in which [ɔ] has strong nasalization.

at anterior locations (ii) there is a greater supply of structures for sensory control towards the front of the mouth, and (iii) acoustic-perceptual effects appear to be stronger at the front than at the back. Combining these observations, Lindblom speculates that the front/back asymmetry may produce a richer range for contrast in vowels produced in the front versus the back of the mouth. If this is so, then we may expect vowels in the back region to be more resistant to nasalization, because of the blurring effect of nasalization on height contrasts. For a firmer grasp of the factors involved in this phenomenon, more investigation is needed.

Rate of speech and stress may effect patterns of nasalization. Two languages in the study report that nasalization spreads through more segments in faster speech. In Kaiwá, glottal stop blocks nasal spreading only in slow speech. In Epera, a Choco language of Panama, voiceless stops normally block the spreading of nasalization, but in 'allegro' or fast speech, nasalization spreads through these segments, leaving them voiceless and prenasalized (Bivin 1986: 102). Stress may affect triggers or blockers of stress: it plays a particularly notable role in the Tupí-Guaraní languages. For example, in Guaraní, a Tupí language of Paraguay, nasal spreading originates from nasal stressed syllables and is blocked by oral stressed syllables. Other languages in which nasal spreading is triggered by a stressed vowel include Ulu Muar Malay (Hendon 1966) and Applecross Gaelic. In the Midwestern variety of American English, nasalization spreads up to and including a stressed syllable but not beyond (Schourup 1973 citing personal communication with Stampe). In Kaiwá, stress affects the degree of nasalization. Bridgeman (1961) notes that in nasal morphemes, nasalization is strongest in stressed syllables and considerably weaker in unstressed positions.

Finally it may be observed that a variable in nasal harmony is the direction of nasal spread. This may be rightward (progressive), leftward (anticipatory) or bidirectional.

Each of these is well-attested; however, when spreading is unidirectional, rightward nasalization across syllables is much more common than nasalization to the left. In spite of this difference in frequency, the direction of spreading is not predictable and must be independently stated.¹⁸

¹⁸ But see Cohn (1993c) for discussion of a general correlation between deletion or effacement of the nasal trigger and directionality of spreading.

2.4.2 The nasal harmony database (condensed version)

i. Vowels (Glottals) Glides Liquids Fricatives Obstruent stops

Language:	Triggers:	Thru:	Dir:	Comments:	Selected Refs:
Barasano (Northern dialect: Tucanoan, Colombia)	Nasal vowels (nasal stops if posited in UR)	V, h	Right	This restrictive right-spreading pattern is quite different from full spreading in the Southern dialect and should be reverified.	Stolte & Stolte 1971; Steriade 1993a
Guahibo (Guahib- Pamaguan: Colombia, Venezuela)	Nasal stops, Nasal vowels	V, h	Right		Kondo & Kondo 1967
Mixtec (Ayutla dialect: Mixtecan: Mexico)	Nasal stops	V, ?	Right	The glottal fricative is rare in this dialect.	Pankratz & Pike 1967
Mixtec (Mixtepec dialect: Mixtecan: Mexico)	Nasal stops	V, ?	Right	There is no [h] in the language.	Pike & Ibach 1978
Mixtec (Molinos dialect: Mixtecan: Mexico)	Nasal stops	V, h, ?	Bidir.	Nasalization is limited to a domain of a disyllabic couplet which forms the nucleus of the phonological word.	Hunter & Pike 1969
Mixtec (Silacayoapan dialect: Mixtecan: Mexico)	Nasal stops, Nasal vowels	V, ?	Bidir.	Nasal harmony is limited to domain of a disyllabic couplet which forms the nucleus of the phonological word.	North & Shields 1977

Language:	Triggers:	Thru:	Dir:	Comments:	Selected Refs:
Pame Otomi (Otopamean; Mexico)	Nasal vowels	V, h, ?	Right	Gibson's description suggests that nasality spreads through more segments, but examples only show spreading through vowels, glottals (as noted by Schourup).	Gibson 1956; Schourup 1973
Sundanese (Hesperonesian; Indonesia)	Nasal stops	V, h, ?	Right	[ʔ] is not phonemic.	Robins 1953, 1957; Howard 1973; Condax et al. 1974; Hart 1981; van der Hulst & Smith 1982; Cohn 1990, 1993a, b, Piggott 1992, Benua 1997; Walker & Pullum 1997
Tinrin (Melanesian)	Nasal stops; Prenasalized stops; Nasal vowels	V	Left	Glottals [h, hw], behave in some ways like voiceless velar continuants.	Osumi 1995

ii. Vowels (Glottals) Glides Liquids Fricatives Obstruent stops

Language:	Triggers:	Thru:	Dir:	Comments:	Selected Refs:
Acehnese (Hesperonesian; Indonesia)	Nasal stop (Nasal V?)	V, j, w, h, ?	Right	Triggering segment in penultimate syllable.	Durie 1985
Aguaruna (Jivaroan; Peru)	h̃, placeless coda nasal	V, j, w	Bidir.	[h̃] is in complementary distribution with a velar nasal.	Payne 1974; Bivin 1986; Trigo 1988

Language:	Triggers:	Thru:	Dir:	Comments:	Selected Refs:
Arabela (Zaparoan: Peru)	Nasal stops. h̃	V, j, w	Right	Glottal fricative is nasal in all environments.	Rich 1963
Bariba (Voltaic: Nigeria)	Nasal stops, nasal vowels	V, j	Left	Spreading seems to be restricted to the syllable.	Welmers 1952
Breton (Celtic: France)	Nasal vowels	V, w	Left	No glottals in the language.	Ternes 1970: Dressler 1972: Schourup 1973: Walker & Pullum 1997
Capanahua (Panoan: Peru)	Nasal stop	V, j, w, h, ?	see note:	Nasality spreads to left, but if nasal C is deleted, spreading is bidirectional.	Loos 1969: Safir 1982: Piggott 1987, 1992: Trigo 1988
Chinantec (Tepetotutla dialect; Chiantecan: Mexico)	Nasal stops, Nasal vowels	V, j, w, weak velar (semi)- cons.	Left	Spreading is syllable-bound.	Westley 1971
Dayak (Kendayan dialect; Indonesian: Borneo)	Nasal stops (?)	V, glots., glides	Right	Description from Court (1970) citing Dunselman.	Dunselman 1949; Court 1970
Dayak (Land - Bukar Sadong dialect; Hesperonesian: Indonesia)	Nasal stops	V, j, w, h, ?	Right	Glottal stop is described by Scott as a 'junction feature'. Glides/glottals block in some words.	Scott 1964: Court 1970
Dayak (Land - Měntu dialect: Indonesian; Sarawak)	Nasal stops	V, j, w, h, ?	Right	Glides/glottals block in some words.	Court 1970

Language:	Triggers:	Thru:	Dir:	Comments:	Selected Refs:
Dayak (Sea dialect; Indonesian; Sarawak)	Nasal stops	V, j, w, glottals (?)	Right		Scott 1957
Konkani (Indo-Iranian; India)	Nasal stops; Nasal vowels	V, j	Left (see note:)	Spreading also to right but just to word-final segments.	Fellbaum 1981; Ghatage 1963; Walker & Pullum 1997
Lamani (Indo-Aryan; Gulbarga District, India)	Nasal vowels	V, j, w	Right	Trail is not explicit about the behavior of [h] in nasalization.	Trail 1970
Madurese (Malayo- Polynesian; Indonesia)	Nasal stops	V, j, w, h, ?	Right	Glides spread through are not phonemic; phonemic glides are rare.	A. Stevens 1968, 1985
Malay (Johore dialect; Indonesian; Malaysia)	Nasal stops	V, j, w, h, ?	Right	Glottal stop is not phonemic.	Dyen 1945; Court 1970; Onn 1980
Malay (Ulu Muar dialect; Indonesian; Malaysia)	Nasal vowels	V, j, w, h, ?	Left	Nasal vowels occur phonemically only in stressed syllables.	Scott 1964; Hendon 1966; Pulleyblank 1989
Marathi (Indo-Aryan; India)	Nasal stops	V, j, w	Left	Nasalization is limited to the syllable. There is no glottal stop. [h] is described as voiced. Whether [h] can be nasalized is unclear.	Pandharipande 1997
Maxakali (Isolate; Brazil)	Nasal stops	V, j, w, h, ?	Bidir.		Gudschinsky et al. 1970; Anderson 1976; Walker & Pullum 1997

Language:	Triggers:	Thru:	Dir:	Comments:	Selected Refs:
Melanau (Mukah dialect; Austronesian; Sarawak)	Nasal stops	V, j, w, h, ?	Right		Blust 1988
Orejon (dialect described by Velie & Velie; Tucanoan; Peru)	Nasal vowels	V, j, h	Right	Nasalization is contrastive only in initial syllable. Behavior of glottal stop is unclear.	Velie & Velie 1981; Cole & Kisseberth 1995
Oriya (Colloquial variety; Indo- Aryan; India)	Nasal stops	V, j, w	Bidir.	Nasalization of vocoids occurs under deletion of a nasal stop in colloquial speech.	Patnaik 1984; Piggott 1987
Rejang (Austronesian; South Sumatra)	Nasal stops	V, j, w	Right	Glottal stop blocks nasal spread. Patterning of [h] is unclear.	McGinn 1979; Coady & McGinn 1982
Saramaccan (Surinam)	Nasal stops	V, j, ɲ	Right	Nasality in syllable rhyme spreads across laminal (palatal) sonorants.	Rountree 1972
Seneca (Iroquoian; Canada, USA)	Nasal stops. Nasal vowels	V, glides, glottals	Bidir.	Chafe reports that [sw] does not block spreading. Some complications in left spreading.	Holmer 1952; Chafe 1967
Terena/o (Arawakan; Brazil)	First person morpheme	V, j, w, ?	Right	Nasalization is morphemic (marks 1st pers). [h, hʲ] pattern as fricatives, not glottals. It is not clear whether /l, r/ block or undergo.	Bendor-Samuel 1960; Leben 1973; Hart 1981; Bivin 1986; Piggott 1987
Warao (Isolate; Venezuela; Guyana)	Nasal stops, Nasal vowels	V, j, w, h	Right	There is no phonemic glottal stop in the language.	Osborn 1966; Piggott 1987; Piggott 1992

Language:	Triggers:	Thru:	Dir:	Comments:	Selected Refs:
Urak Lawoi' (Hesperonesian; Thailand, Malaysia)	Nasal stops	V, j, w	Right	Trigger must be in the penultimate syllable (stressed). Behavior of [h. ?] is not discussed.	Hogan 1988
Urdu (Indo-Iranian; Pakistan, India)	Nasal stops, Nasal vowels	V, j, w, h	Bidir.	There is no phonemic glottal stop in the language.	Hoenigswald 1948; Poser 1982

iii. Vowels (Glottals) Glides Liquids Fricatives Obstruent stops

Language:	Triggers:	Thru:	Dir:	Comments:	Selected Refs:
Edo (Kwa, Nigeria)	Nasal vowels	V, l, r ([+son])	Right	Nasal spreading targets sonorants in suffixes after a nasal stem vowel (glides/ glottals do not occur in relevant affixes).	Aikhionbare 1989
English (Midwestern dialect; Germanic; USA)	Nasal stops	V, j, w, h, l, r	Left	Description from Schourup (1972, 1973) citing Stampe (p.c.). Nasalization spreads only up to a stressed syllable.	Schourup 1972, 1973
Epena Pedee (Saija; Choco; Colombia)	Nasal vowels (nasal stops if posited in UR)	V, j, w, h, r	Right	The flap undergoes nasalization but the trill blocks. Patterning of glottal stop is unclear.	Harms 1985; Bivin 1986
Epera (Choco; Panama)	Nasal morpheme	V, glides, glots., liquids	Right	This describes cross-morpheme spreading. Patterning of voiced fricatives is unclear.	Morris 1977; Bivin 1986

Language:	Triggers:	Thru:	Dir:	Comments:	Selected Refs:
Ewe/Gbe (Kwa; Ghana, Togo, Bénin, Nigeria)	Nasal vowels	j, w, ɥ, l, r, r, ʏ, b	Left	There are no glottals. Spreading is in the syllable. [ɥ, b] alternate with [ŋ, m] and might be treated as sonorants.	Capo 1981
Hindi (Indo-Iranian; India, Pakistan)	Nasal vowels	ʋ, j, w, h, ɽ	Left (bi- dir?)	Nasalization of consonants is supported by nasograph data (M. Ohala 1975).	M. Ohala 1975
Ijo (Kolokuma dialect; Kwa; Nigeria)	Nasal stops. Nasal vowels	ʋ, j, w, r	Left	Williamson (1969) reports a similar pattern in Kalabari and Nembe dialects. Patterning of [h] is unclear.	Williamson 1965, 1969b, 1987; Piggott 1992
Isoko (Ozoro dialect; Kwa; Nigeria)	Nasal vowels	j, w, r, ɽ	Left	Spreading appears to be syllable-bound. Patterning of [h] is unclear.	Mafeni 1969
Kayan (Uma Juman dialect; Austronesian; Sarawak)	Nasal stops	ʋ, j, w, h, ʔ, l	Right	Blust notes that it could not be determined whether /r/ permits carry-over of nasalization.	Blust 1977, 1996
Kpelle (Mande; Liberia, Guinea)	Nasal vowels	ʋ, j, l, ɣ	Right	[ɣ] represents a velar resonant.	Welmers 1962
Mandan (Siouan, USA)		ʋ, w, h, r		Description from Schourup (1972) citing Hollow (1970)	Schourup 1972 (citing Hollow 1970)
Tucano (Tucanoan; Colombia)	Nasal morpheme	ʋ, j, w, h, ʔ, r	Right	This pattern occurs in spreading across morphemes (to alternating affixes). [g] also does not block spreading.	West & Welch 1967, 1972; West 1980; Bivin 1986; Trigo 1988, Noske 1995

Language:	Triggers:	Thru:	Dir:	Comments:	Selected Refs:
Tuyuca (Tucanoan; Colombia, Brazil)	Nasal morpheme	V, j, w, h, r	Right	This pattern occurs in spreading across morphemes (to alternating affixes). [g] also does not block spreading.	Barnes & Takagi de Silzer 1976; Bivin 1986; Barnes 1996
Urhobo (Kwa, Nigeria)	Nasal vowels, Nasal stops?	V, j, w, β, r	Left	[β] represents a bilabial frictionless continuant. There are no glottals in the language.	Kelly 1969; Piggott 1992
Yoruba (Kwa; Nigeria)	Nasal vowels	V, j, w, r, l	Left	/l/ becomes [n] before nasal vowels. Nasal spreading appears to be syllable-bound.	Ward 1952; Bamgbose 1966b, 1969; Pulleyblank 1989

iv. Vowels (Glottals) Glides Liquids Fricatives Obstruent stops

Language:	Triggers:	Thru:	Dir:	Comments:	Selected Refs:
Ennemor (Semitic; Ethiopia)	Unclear	V, j, w, ?, r, β, ʒ	?		Hetzron & Marcos 1966
Itsekeri (Kwa; Nigeria)	Nasal vowels	j, w, r, ʔ	Left	Voiceless fricatives do not undergo. Spreading appears to be syllable bound. There are no glottals in the language	Opubor 1969

Language:	Triggers:	Thru:	Dir:	Comments:	Selected Refs:
Scottish Gaelic (Applecross dialect; Celtic; Scotland)	Nasal vowels (in a stressed syllable)	V, glides, glots., liqs., frics.	Right (see note:)	Nasalization also extends to onset of the stressed syllable. Mid-high vowels are never nasalized and block spreading.	Ternes 1973. van der Hulst & Smith 1982; Piggott 1992
UMbundu (Benue-Congo; Angola)	Nasal continuant consonants. Nasal vowels	V, j, w, h, l, v	Bidir.	In addition to nasal stops and vowels, Umbundu has /ṽ, ĩ, ĵ, ĥ/. Domain of spreading is complicated — see Schadeberg (1982).	Schadeberg 1982

v. Vowels (Glottals) Glides Liquids Fricatives Obstruent stops

Language:	Triggers:	Thru:	Dir:	Comments:	Selected Refs:
Apinayé (Ge: Brazil)	Nasal vowels	j, r, v, nasal or voiced stops	Bidir.	Spreading is limited to syllable. /j, r, v/ each range between glide, liquid, and fricative constriction. Nasal/voiced stops are fully nasal in nasal syllables; otherwise they are pre/post-nasalized.	Burgess & Ham 1968; Steriade 1993a
Barasano (Northern dialect; Tucanoan, Colombia)	Nasal vowels	All classes of segs	Left	Nasal spreading to left is syllable-bound. Voiceless stops remain oral.	Stolte & Stolte 1971; Steriade 1993a

Language:	Triggers:	Thru:	Dir:	Comments:	Selected Refs:
Barasano (Southern dialect; Tucanoan, Colombia)	Morpheme-level property (or nasal vowel/ stop)	All segs	Bidir.	Voiceless segments behave transparent.	Smith & Smith 1971; Jones & Jones 1991; Piggott 1992. Rice 1993; Steriade 1993a
Bribri (Chibchan; Costa Rica)	Nasal vowel in a tonic syllable.	All classes of segs	Left	Voiceless obstruents block spreading. Spreading targets atonic syllables.	Constenla 1985
Cabécar (Southern dialect; Chibchan)	Nasal vowels	All classes of segs	Left	Voiceless obstruents block spreading.	Constenla 1985
Cabécar (Northern dialect; Chibchan)	Nasal vowels	All classes of segs	Left	Voiceless obstruents behave transparent to spreading.	Constenla 1985
Cayuvava (Bolivia)	Nasal stops, nasal vowels	All classes of segs	Bidir.	Voiceless obstruents behave transparent. Description is vague concerning domain and nasalization of some intervening consonants.	Key 1961, 1967
Cubeo (Tucanoan; Colombia)	Nasal vowels	All classes of segs	Left	Voiceless stops remain oral. Salser describes this as spreading to onsets: it is unclear whether spreading across syllables takes place.	Salser 1971
Desano (Tucanoan; Colombia, Brazil)	Morpheme-level property (or nasal vowel/ stop)	All segs	Bidir.	Voiceless segments behave transparent.	Kaye 1971; Leben 1973; Miller 1976; Bivin 1986; Steriade 1993a

Language:	Triggers:	Thru:	Dir:	Comments:	Selected Refs:
Epena Pedee (Saija; Choco; Colombia)	Nasal vowels (nasal stops if posited in UR)	All classes of segs	Left	Voiceless stops remain oral; voiceless fricatives are reportedly nasalized. Left spreading is restricted to syllable.	Harms 1985. 1994; Bivin 1986
Epera (Choco; Panama)	Nasal vowels (?)	All classes of segs	Right	This for morpheme- internal spreading. Voiceless obstruents block in 'normal' speech; but they behave transparent in fast speech.	Morris 1977; Bivin 1986
Gbeya (Adamawa- Eastern; Central African Republic)	Nasal vowels	All classes of segs	Right	Voiceless stops remain oral. Behavior of fricatives and voiced stops is unclear.	Samarin 1966; Steriade 1993a
Gokana (Benue-Congo; Nigeria)	Nasal stops, nasal vowels	All classes of segs	Right	Voiceless segments do not occur in the environment for nasalization (they occur only initially). There are no glottals.	Hyman 1982; Piggott 1987; Steriade 1993a
Guanano (Tucanoan; Colombia)	Morpheme- level property (or nasal vowel/ stop)	All segs	Bidir.	Voiceless segments behave transparent.	Waltz & Waltz 1967, 1972; Bivin 1986
Guaraní (Tupí; Paraguay, Brazil, Argentina)	Nasal vowel in a stressed syllable	All segs	Bidir.	Voiceless segments behave transparent. Stressed syllables containing an oral vowel block spreading.	Gregores & Suárez 1967; Rivas 1974, 1975 (for others see chapter 4)

Language:	Triggers:	Thru:	Dir:	Comments:	Selected Refs:
Guaymi (Panama)	Near past completed action morpheme	All classes of segs	Right	Nasalization marks near past completed action in class II verbs. Voiceless consonants and back vowels block. Voiced obstruents are variable in their behavior.	Kopesecc & Kopesecc 1974, 1975; Bivin 1986
Igbo (Central. Ohuhu dialect; Igbo; Nigeria)	Syllable-level property (or nasal stops and nasal vowels)	All classes of segs	Bidir.	With the exception of voiceless stops, all segments are reported to have nasal alternants, including fricatives.	Green & Igwe 1963 Williamson 1969a; Clark 1990:
Icua Tupí (Tupí-Guaraní; Brazil)	Morpheme-level property (or nasal vowel)	All classes of segs	Bidir.	Description is only tentative: based on speakers. Realization of /h/ and /r/ in a nasal context is unclear.	Abrahamson 1968; Bivin 1986
Kaiwá (Tupí-Guaraní; Brazil)	Morpheme-level property (or nasal vowel/ stop)	V, glides, glots., liqs., frics., stops	Bidir.	Glottal stops block nasal spread in slow speech. Realization of glides, liquids, and fricatives in nasal contexts is unclear. Voiceless stops are transparent.	Bridgeman 1961; Harrison & Taylor 1971
Mixtec (Atatlahuca dialect; Mixtecan; Mexico)	Morpheme level property or last vowel	All classes of segs	Left	Voiceless obstruents block spreading. Voiced segments become nasalized.	Alexander 1980; Marlett 1992
Mixtec (Coatzospan dialect; Mixtecan; Mexico)	Second person familiar morpheme	All classes of segs	Left	Voiceless obstruents generally block spreading. Voiced obstruents behave transparent.	Pike & Small 1974; Piggott 1992; Gerfen 1996

Language:	Triggers:	Thru:	Dir:	Comments:	Selected Refs:
Mixtec (Ocatepec dialect; Mixtecan; Mexico)	Morpheme level property or last vowel	All classes of segs	Left	Voiceless obstruents behave transparent to spreading. Voiced segments become nasalized	Marlett 1992
Orejon (dialect described by Arnaiz; Tucanoan; Peru)	Morpheme-level property or first syllable	All classes of segs	Right	Description from Pulleyblank citing Arnaiz. Voiceless obstruents block spreading. Voiced obstruents are nasalized.	Arnaiz 1988; Pulleyblank 1989
Parintintin (Tupí-Guaraní; Brazil)	Nasal vowels (or morpheme-level property)	All classes of segs	?	Voiceless obstruents block spreading. Voiced obstruents are nasalized.	Pease & Betts 1971; Bivin 1986
Shiriana (Shirianan; Venezuela. Brazil)	Nasal vowel (or foot-level property)	All classes of segs	Bidir.	Nasal spreading is bounded by the foot. It is unclear whether all obstruents behave transparent or whether some become nasalized.	Migliazza & Grimes 1961
Siriano (Tucanoan. Colombia, Brazil)	Morpheme-level property (or nasal vowel/ stop)	All segs	Bidir.	Voiceless segments behave transparent.	Bivin 1986 (citing Malone et al. 1985)
Tatuyo (Tucanoan; Colombia)	Morpheme-level property (or nasal vowel/ stop)	All segs	Bidir.	Voiceless segments behave transparent.	Gomez-Imbert 1980; Steriade 1993a
Tucano (Tucanoan; Colombia)	Morpheme-level property (or nasal vowel/ stop)	All segs	Bidir.	Voiceless segments behave transparent. This pattern occurs in morpheme-internal spreading.	West & Welch 1967, 1972; West 1980; Bivin 1986; Trigo 1988. Noske 1995

Language:	Triggers:	Thru:	Dir:	Comments:	Selected Refs:
Tuyuca (Tucanoan: Colombia, Brazil)	Morpheme- level property (or nasal vowel/ stop)	All segs	Bidir.	Voiceless segments behave transparent. This pattern occurs in morpheme- internal spreading.	Barnes & Takagi de Silzer 1976; Bivin 1986; Barnes & Malone 1988; Barnes 1996

Chapter 3

SEGMENTAL TRANSPARENCY AS AN OPACITY EFFECT

This chapter examines the analysis of transparent segments in nasal harmony, that is, segments which are produced with a raised velum within a nasal span. This realization of a truly oral segment within a nasal spreading domain is problematic because it presents a case which appears to deny the claim that feature spreading is segmentally strictly local. Chapter two maintained that a spreading nasal feature propagates only between immediately adjacent segments; skipping a segment is not a possible outcome in spreading. This result follows from the well-motivated assumption that the gapped configuration is universally ill-formed: a representational consequence of interpreting a multiply-linked feature as a continuous property or gesture. In the previous chapter, evidence was adduced from the typology of nasal harmony in support of the claim that descriptively transparent segments should be analytically grouped with undergoers of nasal spreading. Some antecedent derivational or sequential multi-level accounts of truly transparent segments have maintained the strict locality of spreading by positing a level of representation at which the transparent segment undergoes spreading (e.g. Clements 1976; Vago 1976; Walker 1996; Ní Chiosáin and Padgett 1997). A subsequent rule or constraint then applies to this representation to change the feature specification on the transparent segment to realize its surface transparency. More generally, this kind of approach analyzes true transparency as an instance of a 'derivational opacity effect' (Kiparsky 1971, 1973), in the sense of an outcome that is derived through an opaque interaction of rules or constraints. For transparent segments in nasal harmony, I follow this core idea by analyzing transparency as the outcome of an opaque interaction of optimality-theoretic constraints.

In Optimality Theory, it has recently been proposed that derivational opacity effects can be achieved by calling on a correspondence relation that enforces faith between co-

candidates in the evaluation set: the output candidate and a designated ‘sympathy’ candidate (McCarthy 1997, with developments proposed by Itô and Mester 1997a, b). The sympathy approach to opacity effects is capable of producing transparent segments in spreading without producing gapped configurations, and it is independently motivated by other derivational opacity effects known to occur in language. This chapter develops a version of Sympathy theory in which opacity effects arise from the organization of the phonological constraint hierarchy into contiguous subgroups. Within this organizational structure, sympathetic faith is utilized to produce opaque constraint interactions, including transparency in nasal harmony. This is the *harmonic sympathy* model of opacity in grammar.

This chapter is organized as follows. First, in section 3.1 I review the arguments that some kinds of transparent segments truly are surface-transparent to a spreading feature and I preview the sympathy-based analysis of transparency in Tuyuca. Section 3.2 then establishes the harmonic sympathy model of the grammar, with exemplification from a derivational opacity effect in Tiberian Hebrew. In section 3.3 I develop the full analysis of transparency in Tuyuca as well as the blocking effects in spreading to suffixes. Section 3.4 presents some points of comparison between the harmonic sympathy model and the ‘constraint-based’ model of sympathy introduced by McCarthy (1997) with modifications proposed by Itô and Mester (1997a, b). It is argued that harmonic sympathy brings a firmer understanding to what brings about opaque constraint interactions and the evaluative mechanisms involved in selection of the sympathy candidate. Section 3.5 then applies the harmonic sympathy framework to Finnish, analyzing the transparent behavior of certain vowels in vowel harmony as a (derivational) opacity effect. Section 3.6 discusses an evaluation metric for derivational opacity in a grammar. And finally, an appendix in section 3.7 presents a possible account of German truncation under harmonic sympathy, reworking a recent analysis of these facts in the constraint-based model proposed by Itô

and Mester (1997a). A drawback for harmonic sympathy is discussed and a revision is proposed which better incorporates the strengths of constraint-based model.

3.1 Antagonistic transparency

A few different proposals have been made to preserve the segmentally strict locality of spreading in cases where there appears to be transparency, that is, where it appears that feature spreading has skipped a segment. These proposals fall into two main analytical directions. One line of research has argued that in certain kinds of so-called 'transparency', the relevant gesture is actually carried through a segment. I call this kind of transparency, *false transparency*. Ní Chiosáin and Padgett (1997) take this approach for 'transparent' consonants in vowel harmonies, arguing that consonants actually undergo the feature spreading but may be perceived as transparent because the consequences of the spreading property are small in terms of contrast potential for these segments. Gafos (1996) also claims that transparent segments in coronal consonant harmonies are falsely transparent. He too argues that all segments undergo the harmony, but perceived transparency arises when the spreading gesture does not produce acoustic/perceptual consequences in a given segment. Flemming (1995b) makes the same point in his analysis of the coronal harmony facts. Building on Walker (1996), Walker and Pullum (1997) take a similar line for 'transparent' glottal stops in nasal harmony (see discussion in section 2.2.3). In work with a somewhat different rhetorical focus, it has been proposed that false transparency may arise with segments which are less marked, because they better tolerate the cooccurrence of other features. McCarthy (1994) suggests this account for the transparency of coronals in vocalic pharyngeal harmony, and Padgett (1995a) makes this proposal for translaryngeal vowel harmony. All of the false transparency analyses are unified by the claim that the spreading feature is *compatible* with the 'transparent' segment.

A second kind of analysis addresses cases where the transparent segment truly appears to surface with an opposing feature specification to the spreading property. This kind of true neutrality I will refer to as *antagonistic transparency*, borrowing terminology from Archangeli and Pulleyblank (1994: 232). For these cases, it has been proposed that the transparent segments actually undergo spreading at some abstract level of phonological representation (e.g. Clements 1976; Vago 1976; Walker 1996; Ní Chiosáin and Padgett 1997). With foundation in the early generative analyses of Clements and Vago, Walker (1996) and Ní Chiosáin and Padgett (1997) construct optimality-theoretic accounts in which the output of this abstract level forms the input to a second level, at which a ‘realizational’ or ‘phonetic’ mapping takes place, and in this second level, the transparent segment is changed to bear the opposite feature specification to the spreading one in order to resolve some kind of incompatibility. Ní Chiosáin and Padgett suggest that this change takes place for transparent vowels in vowel harmony to satisfy the demands of contrast, and for nasal harmony, Walker argues that the change occurs in obstruents because of a phonetic incompatibility of feature specifications. This kind of level-based analysis differs from the false transparency proposals in two important ways. First, it assumes that the transparent segment is actually specified for the opposite specification of the spreading feature in the output, i.e. this analysis concedes transparency, and second, it makes use of an additional level of representation.

The previous proposals are not incompatible with each other, rather they have shown that apparent transparency may arise under two different sets of circumstances. Our concern lies with antagonistic transparency. I will propose a somewhat different analysis of these cases. I will argue that it is indeed correct that antagonistically transparent segments are specified for the opposite feature specification of the spreading feature in the actual output, but I will show we need not call on a second level of input-output mapping to achieve this result — it can be captured in a one-level framework, following the core

'Sympathy' theory proposal of McCarthy (1997) and developments by Itô and Mester (1997a, b). The primary focus of this discussion will be transparency in nasal harmony, but I will also demonstrate the application of this model to antagonistic transparency in vowel harmony. On a broader scale, I will show that this model can capture a range of effects of the kind that in derivational frameworks were derived from derivationally-opaque rule interactions: so-called 'opacity effects' ('opacity' in the sense of Kiparsky 1971, 1973).

In antagonistic transparency, the spreading feature specification is incompatible with some acoustic or articulatory property of the transparent segment. Archangeli and Pulleyblank (1994) point out that in [+ATR] harmony in Kinande, the low vowel behaves transparent because the feature specification [+ATR] is antagonistic to the specification [+low]. However, in the case of vowel feature combinations, this incompatibility is not absolute: in Vata, for example, (Eastern Kru; Ivory Coast; Kaye 1982), [+low] vowels clearly undergo [+ATR] spreading. Further, even in Kinande, a low vowel that is long and low-toned exhibits a [+ATR] variant in harmonic domains (Hyman 1989; also noted by Archangeli & Pulleyblank 1994: 210). We may conclude that cross-linguistically the feature combination [+ATR, +low] is highly disfavored, where disfavoring of feature combinations arises from articulatory/aerodynamic or acoustic/perceptual factors (in the Grounded Phonology framework of Archangeli and Pulleyblank 1994, these are formalized as phonetic 'Grounding Conditions'). In optimality-theoretic terms, the dispreference for low [+ATR] vowels is captured by ranking the feature cooccurrence constraint, *[+ATR, -low], high in the hierarchy of [+ATR] cooccurrence constraints. Indeed, this constraint is often undominated.

Although a strong dispreference for a feature combination in a language can drive transparency in the case of vowel harmony, the transparency of buccal obstruent stops to nasal spreading is somewhat more extreme. This is a case of antagonistic transparency

where the segment that would be derived from spreading onto the transparent segment is more than just disfavored, it is a phonetically impossible segment, that is, it cannot not be pronounced in any language. *Buccal* obstruents are those with a place of articulation forward of the place where the velic valve joins the nasal and oral cavities (Ohala and Ohala 1993). A nasalized buccal obstruent is phonetically impossible because the specification [+nasal], requiring that the segment be produced with a lowered velum (Howard 1973; Cohn 1993a, Walker and Pullum 1997), conflicts with satisfaction of the property defining the segment as an obstruent stop.

Analysts differ to some extent on the precise characterization of the property defining an obstruent stop, but all agree that at least in buccal segments it is incompatible with a velic opening. Ohala and Ohala see an obstruent stop as having the requirement that the stop accumulate a sufficient degree of air pressure behind the oral constriction to produce audible turbulence on release, i.e. a burst (1993: 227). They observe that a lowered velum will prevent the necessary build-up of air in the oral cavity by allowing air to escape through the nose. Steriade (1993a, d, 1994) makes another release-related characterization in the form of aperture-theoretic representations.

Many feature-based approaches make use of the feature [-sonorant]. The feature [\pm sonorant] distinguishes sounds with a cavity configuration that inhibits airflow through the glottis, thereby inhibiting spontaneous vocal cord vibration, from those having a cavity configuration that allows enough airflow to normally produce voicing (Chomsky and Halle 1968; Kenstowicz 1994: 36 provides clarifying discussion). In order for air to flow through the glottis, the supralaryngeal air pressure must be less than the sublaryngeal pressure. [-sonorant], characterizing obstruents, thus expresses the requirement that a segment have an accumulation of supralaryngeal pressure sufficient to inhibit spontaneous voicing. Oral stops and fricatives are nonsonorant because their high degree of constriction produces a build-up of pressure and restricts airflow. On the other hand, the weaker

constriction of vowels, glides, and liquids is associated with that of [+sonorant] sounds. Although nasal stops have a complete oral closure, they are classified as sonorants because the airflow permitted by the open nasal passage normally induces voicing.¹ [-sonorant] precludes simultaneous implementation of [+nasal] in a buccal segment, because the nasal airflow conflicts with the increase in supralaryngeal pressure required in a nonsonorant (Chomsky and Halle 1968: 316). Since I am assuming feature-based representations, I will continue to use the feature [-sonorant] to characterize obstruents; however, distinguishing a closure and a release phase of an obstruent stop makes an important contribution to understanding certain prenasalization phenomena, and I do not rule out the possibility that such representations might be called on in the theory. The constraint *NASOBSTOP, which prohibits the cooccurrence of the feature specifications [+nasal, -sonorant, -continuant], is the one that bans nasalized obstruent stops.

The key generalization that emerges from each of the different approaches to characterizing obstruents is that a buccal obstruent stop cannot be produced simultaneously with nasality, and so a 'transparent' obstruent stop must actually be specified as [-nasal] in the output. This kind of transparency thus cannot fall under the set of false transparency cases where the spreading feature is actually implemented on the transparent segment in the output; the phonetic impossibility of a nasalized obstruent enforces a true transparency outcome for these segments in all cases where nasalization appears to spread through them. The position I will argue for in this chapter is that true surface transparency can be derived for antagonistically transparent segments while still respecting strict segmental locality of feature linking and spreading in all phonological representations. I follow Walker (1996)

¹ Chomsky and Halle observe that there are occasionally instances of contrast between voiced and voiceless nasals (1968: 316). However, voiceless nasals are still classified as sonorants, because the failure of these sounds to be voiced results not from a supralaryngeal pressure inhibiting airflow through the glottis but rather from a glottal spreading gesture (see also Mester and Itô 1989 and Lombardi 1991 who classify voiceless nasals as sonorants). Ohala and Ohala (1993: 231-233) suggest that the turbulence that occurs in the production of a voiceless nasal is sufficient to qualify it as nonsonorant; however, they assume a somewhat different characterization of obstruency.

and Ní Chiosáin and Padgett (1997) in achieving this outcome by calling on a correspondence relation between an abstract representation in which all segments undergo spreading and the surface transparent output. However, rather than make use of an IDENT-IO constraint in a model with two input-output levels, I will make use of an IDENT constraint mapping between the abstract representation and the output as co-candidates in the evaluation set, thereby maintaining a model with just one input-output level. This move ensures that just one ranking of the constraints forms the grammar of a language: introducing levels allows for the possibility of reranking constraints at each level.

The idea of a faith relation from one candidate to another within a single candidate set is due to McCarthy (1997) and elaborated in the work of Itô and Mester (1997a, b) in breakthrough studies in the analysis of derivational opacity effects in OT. This co-candidate faith relation establishes a correspondence mapping from a designated candidate in the evaluation set to the actual output, and it promotes an output form which resembles the designated candidate, that is, it favors an output which is in *sympathy* with a particular candidate. In some cases the constraint hierarchy will be such that the sympathy candidate coincides with the actual output; however, when the sympathy candidate fails on the basis of some high-ranked constraint, then it may influence the selection of the optimal output through the correspondence relation between the sympathetic candidate and the output. This sympathetic faith relation is abbreviated as Faith- \otimes O, as expressed by Itô and Mester (1997a, b), with the ' \otimes ' symbol referring to the sympathetic candidate. As McCarthy points out, the value of Faith- \otimes O constraints is that they are capable of producing opacity effects of the type previously obtained through derivationally-opaque rule interactions. This arises under circumstances where the sympathetic candidate loses but is resembled in the output by the force of Faith- \otimes O (for recent applications of this approach see Itô and Mester 1997a, b; Karvonen and Sherman 1997a, b; Merchant 1997; Davis 1997; Katayama 1998; Sanders 1997 provides a more general examination of sympathetic correspondence).

The emergence of truly transparent segments in spreading has been analyzed in derivational models with opaque rule interactions. An example of this kind of analysis for nasal harmony in an SPE-style framework is summarized in (1) (using a hypothetical form).

(1) Transparency through derivationally-opaque rule interaction:

a. Rules:

i. Nasal Spreading (iterative):

$X \rightarrow [+nasal] / [+nasal] _$ (X is any segment)

ii. Obstruent stop denasalization:

$[-sonorant, -continuant] \rightarrow [-nasal]$

Nasal spreading is ordered before obstruent stop denasalization.

b. Derivation:

Underlying representation	/ārato/
Nasal spreading	ārātō
Obstruent stop denasalization	ārātō
Surface representation	[ārātō]

Examples of this basic type of approach to transparency in vowel harmony appear in Clements (1976) and Vago (1976). Analyses of this kind are also typically *abstract* in the sense that at some level of representation it calls on a segmental structure that never actually surfaces in any output form of the language. In the above example, the abstract segment is a nasalized alveolar obstruent stop. More generally, derivationally-opaque rule-based accounts which assume some abstractness (i.e. segments that never actually occur in any output of the language) appear in analyses by Kisseberth (1969), Hyman (1970). Brame

(1972), and Vago (1973), among others (for a more complete list see references in Kiparsky 1971, 1973; see also this source for general discussion of the issue of abstractness). Many of these cases posit an underlying segment that undergoes *absolute neutralization* (terminology after Kiparsky 1971, 1973), i.e. its contrast with another underlying form is neutralized in all environments at the surface. In the nasal harmony example above, the abstract segmental representation occurs not underlyingly, but at an intermediate level of representation.

The abstract treatment of transparency can be reproduced in Optimality Theory under the sympathy approach to deriving opacity effects. The diagram in (2) illustrates the structure of the correspondence mappings in relation to the analysis in (1). The underlying representation matches the input and each of the representations derived at some stage of the derivation in (1) are included as members of the candidate set of outputs. Faith-IO constraints evaluate the faithfulness of each of the candidate outputs to the input. The intermediate representation with full spreading in (1) is designated as the sympathy candidate within the evaluation set; Faith- \emptyset O constraints will enforce the resemblance of the actual output to this candidate. The actual output will be the surface representation from (1).

(2) Sympathetic correspondence and segmental transparency:

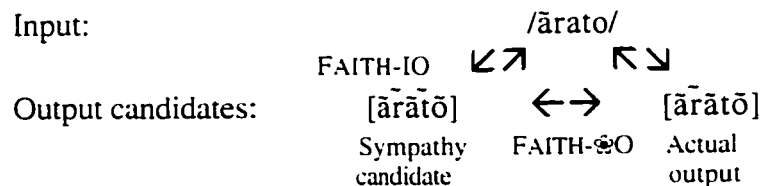

In order for the sympathy candidate not to win itself, it must lose on the basis of some high-ranked constraint. This will be the constraint banning nasal obstruent stops, which

plays the role of the obstruent stop denasalization rule. The actual output is the candidate most closely resembling this candidate while still respecting *NASOBSSTOP.

It is important to note that all of the candidate representations being evaluated still respect locality, that is, a representation with gapping across a segment is never generated or called on for comparison. The representation of the actual output with a transparent obstruent is like that shown in (3a), with a separate [+nasal] feature specification on either side of the transparent segment; it is not as in (3b) with one [+nasal] feature specification bridging across the transparent segment. This kind of representation is universally ill-formed because a single feature occurrence fails to correspond to a continuous gesture: on formal grounds, the representation fails to be *convex* (after Ní Chiosain and Padgett 1997, recall discussion in 2.2.1). This form thus is never a member of the candidate set.

- (3) a. The representation of the actual output

$\bar{a} \quad \bar{r} \quad \bar{a} \quad t \quad \bar{o}$
 $\quad \backslash \quad / \quad \quad \quad |$
 [+nasal] [+nasal]

- b. An ill-formed representation: never part of the candidate set

$\bar{a} \quad \bar{r} \quad \bar{a} \quad t \quad \bar{o}$
 $\quad \backslash \quad \backslash \quad | \quad /$
 [+nasal]

As observed in chapter 2, an outcome like that in (3a) cannot be obtained directly from spreading. Spreading requires that each occurrence of a feature specification be linked to all segments in the morpheme: it is not satisfied by candidates containing separate projected copies of that feature. (3a) is instead selected on this basis of its being the best possible match to the sympathetic candidate, with full nasal spreading, represented as in (4).

(4) The representation of the sympathetic candidate

ā r̄ ā t̄ õ
 \ \ / / /
 [+nasal]

Crucially, featural correspondence between the sympathetic fully nasal candidate and the actual output is enforced by an IDENT[Feature] constraint, which requires not that features themselves have correspondents but that the *featural properties* of correspondent segments are identical (McCarthy and Prince 1995). It is the IDENT- \leftrightarrow O correspondence relation for [+nasal] that produces the occurrence of separate [+nasal] features on either side of the transparent segment in the optimal output, that is, the optimality of the representation in (3a) is driven by its similarity in featural properties to the fully spread candidate in (4), even though (3a) itself fares quite poorly with respect to spreading and involves introducing an extra occurrence of [+nasal]. This result provides support for a view of featural faith mediated through segmental identity, given by the IDENT[F] formulation: an alternative view of featural faith in which features themselves are in correspondence could not realize this outcome.²

A preview of the constraint ranking deriving segmental transparency through sympathy is given in the tableau in (5). The candidate with full nasal spreading, in (a), is designated here as the sympathy candidate, signalled by the flower symbol at its right. This candidate loses in the contention for the optimal output, because it incurs a fatal violation of the undominated constraint prohibiting nasalized obstruent stops. The next highest constraint is the sympathetic faith constraint requiring identity between the sympathy candidate (a) and the actual output in the [+nasal] property of segments.

² On some of the pros and cons of a correspondence view of features see McCarthy and Prince (1995); Lombardi (1995a, 1998); Causley (1996), Walker (1997b); Yip (to appear); (cf. also Lamontagne and Rice 1995).

Candidate (c), which matches [+nasal] identity in all but [t], is the best of the candidates respecting *NASOBSSTOP on this faith constraint. The alternative in (b) loses because in addition to [t], the next segment [o] is also oral. This extra IDENT- \emptyset O faith violation is fatal, even though (b) is much better than (c) on spreading.

(5) Preview of sympathy analysis of segmental transparency

	ārato	*NAS OBSSTOP	IDENT- \emptyset O [+nasal]	SPREAD [+nasal]
\emptyset	a. [ārātō]	*!		
	b. [ārā]to		**!	**
\emptyset	c. [ārā]t[ō]		*	*****

The tableau in (5) shows how sympathy can derive the effect of an opaque rule interaction of the type used to produce segmental transparency in spreading, while still maintaining a restrictive conception of locality. Central to this account is the notion of a designated sympathy candidate. It is natural to question how this designation takes place. This will be the subject of the next section, which examines an opacity interaction in Tiberian Hebrew. This next section will complete the outline of the model for deriving opacity effects in Optimality Theory, and I will then go on to develop a full account of transparency and blocking effects in nasal harmony in Tuyuca.

3.2 Opacity in Tiberian Hebrew

A classic case of the type demanding a derivationally-opaque rule interaction occurs in the interaction of epenthesis and laryngeal coda deletion in Tiberian Hebrew. The description and generative analysis of this phenomenon are from Malone (1993) (see also Prince 1975), and they are summarized by McCarthy (1997) in his foundational study of the sympathy-based approach to opacity effects in Optimality Theory. An SPE characterization

of the rules is given in (6). The first rule epenthesizes a vowel into a word-final consonant cluster (Malone 1993: 93)³ and the second deletes glottal stop in a coda (Malone 1993: 59).⁴

(6) Tiberian Hebrew

a. Vowel epenthesis into final clusters:

$\emptyset \rightarrow V / C _ C\#$

e.g. /melk/ → [melEk] 'king'

b. ?-deletion in codas:

$? \rightarrow \emptyset / _]\sigma$

e.g. /qara?/ → [qara] 'he called'

The rules in (6) have the potential to interact with one another. As shown in (7), they operate in a counterbleeding order, whereby epenthesis takes place before ?-deletion. This gives a surface form [deʃE] for /deʃ?/, which is opaque with respect to epenthesis, that is, there is an occurrence of an epenthetic vowel in a surface environment that does not meet the structural description of the epenthesis rule.

³ The surface quality of the epenthetic vowel is partly conditioned by the environment. If the first consonant in the cluster is the palatal glide [j], then the epenthetic vowel is [i]. If the first consonant is a guttural, then the vowel is [a]. Otherwise, the epenthetic vowel is [e] (transcribed by Malone as [ɛ]).

⁴ The examples given here focus only on the segmental alternations relevant to the rules in (6). I abstract away from alternations brought about by rules such as vowel lengthening and post-vocalic spirantization (Prince 1975; Malone 1993).

(7) Counterbleeding in Tiberian Hebrew:

Underlying representation	/deʃʔ/	
V-epenthesis	deʃEʔ	
ʔ deletion	deʃE	
Surface representation	[deʃE]	*deʃ

Following McCarthy's (1997) insightful and innovative analysis, the basic architecture of the sympathy-based account of this derivational opacity will be as illustrated in (8). Candidate (b), [deʃEʔ], is designated as the sympathy candidate, but it loses in the competition for the optimal output on the basis of a high-ranked constraint prohibiting glottal stop in a coda. The sympathetic faith constraint, MAX- \otimes O, then decides between the two alternative candidates in (a) and (c). Candidate (a), [deʃE], which corresponds to the opaque rule interaction, is the winner, omitting only one segment that appears in the sympathetic candidate. Candidate (c), [deʃ], which corresponds to a transparent rule interaction, loses because it omits two segments that appear in the sympathetic candidate.

(8) Overview of the sympathy account

	Input /deʃʔ/	*ʔ] _σ	MAX- \otimes O
☞	a. deʃE (Optimal, opaque rule interaction)		*
\otimes	b. deʃEʔ (Non-optimal, sympathetic)	*!	
	c. deʃ (Non-optimal, transparent rule interaction)		**!

To develop the full sympathy account of this opacity effect in Tiberian Hebrew, we must begin by reviewing the constraints and preliminary rankings established by McCarthy

(1997) that correspond to the rules outlined in the derivational analysis. First, to drive epenthesis into a consonant cluster, *COMPLEX (Prince and Smolensky 1993) must outrank the faith constraint prohibiting addition of structure, DEP-IO (McCarthy and Prince 1995).

(9) *COMPLEX >> DEP-IO

	/melk/	*COMPLEX	DEP-IO
↗	a. melEk		*
	b. melk	*!	

In order to resolve the cluster by epenthesis rather than deletion, MAX-IO must outrank DEP-IO.

(10) MAX-IO >> DEP-IO

	/melk/	MAX-IO	DEP-IO
↗	a. melEk		*
	b. mel	*!	

Locating the site of epenthesis between the consonants rather than after them is achieved with the correspondence constraint, R-ANCHOR-IO (McCarthy and Prince 1995: 371), which requires that the rightmost element of the input have a correspondent in the rightmost element of the output. This constraint is abbreviated below as ANCHOR-R.⁵

⁵ Rather than ANCHOR-R, McCarthy's account makes use of the constraint, ALIGN-R_{IO}(Root, σ).

(11) ANCHOR-R

	/melk/	ANCHOR-R
☞	a. melEk	
	b. melkE	*!

The second rule in the derivational analysis performs glottal stop coda deletion. This kind of outcome can be realized in Optimality Theory by ranking a constraint prohibiting glottal stop in a coda over MAX-IO.⁶

(12) *ʔ]_σ >> MAX-IO

	/qaraʔ/	*ʔ] _σ	MAX-IO
☞	a. qara		*
	b. qaraʔ	*!	

ʔ-deletion enforces a violation of right-anchoring, so *ʔ]_σ must outrank ANCHOR-R.

(13) *ʔ]_σ >> ANCHOR-R

	/qaraʔ/	*ʔ] _σ	ANCHOR-R
☞	a. qara		*
	b. qaraʔ	*!	

As McCarthy notes, the constraint hierarchy that has been established thus far cannot be the full story because it determines the wrong outcome for an input like /deʃʔ/. The outcome that would be selected here is [deʃʔE] rather than [deʃE]. This incorrect outcome is signalled by the left-pointing hand beside the predicted but incorrect winner. The right-pointing hand indicates the desired winner.

⁶ McCarthy calls the constraint prohibiting glottal stops in codas: 'CODACOND'.

(14) Incorrect outcome is predicted for /defʔ/

	/defʔ/	1. *ʔ]σ 2. *COMPLEX	ANCHOR-R	MAX-IO	DEP-IO
☞	a. defE		*	*!	*
(☞)	b. defEʔ	*! (1)			*
☞	c. defʔE		*		*
	d. def		*	*!	
	e. defʔ	*!(1, 2)			

Because candidate (c) incurs a subset of the violations that (a) does, no reranking will serve to select candidate (a) over (c). Even if another constraint were invoked to rule out (c), a second problematic competitor is the transparent derivational candidate [def], which also incurs a subset of the violations that (a) does. To realize the correct outcome, it will be necessary to call on a faith relation to a sympathy candidate. As McCarthy suggests, this sympathy candidate will be the one in (b). It is in the means of selection of the sympathy candidate that I depart from McCarthy's account. My proposal is outlined below; its goal is to develop a means of selecting the sympathy candidate by building on the basic mechanisms of optimality-theoretic evaluation and to constrain the range of opacity effects that may be produced under sympathy. I compare this with the alternative proposed by McCarthy (with modifications proposed by Itô and Mester 1997a, b) in section 3.4.

The question we are faced with is how to select the sympathy candidate. In order to answer this question, the problem presented by the tableau in (14) must be carefully considered. An important basis of Optimality Theory is the notion of *ranked* and *violable* constraints in conflict. In the normal case, when the satisfaction of two constraints conflicts, the conflict is resolved by a ranking which forces the violation of one constraint over the other. This is what occurs in (14), where ranking *ʔ]σ over ANCHOR-R causes

the sympathy candidate, in (b), to lose to alternatives without a laryngeal coda. In this resolution, $*?]_{\sigma}$ gains undominated status in the constraint hierarchy, along with $*\text{COMPLEX}$. Under this normal resolution of the conflict between $*?]_{\sigma}$ and ANCHOR-R, the ANCHOR-R constraint loses absolutely: for example, here candidate (c) wins over alternatives, even though it is quite different from the one that would have been selected by ANCHOR-R. However, as (14) shows, this produces the wrong outcome for Tiberian Hebrew. The candidate that would have been chosen if ANCHOR-R had won the conflict turns out to influence selection of the optimal output. This influencing candidate is the sympathetic one in (b). It fails because of its glottal stop coda: but setting the glottal stop coda constraint aside, we may observe that it is the most harmonic candidate with respect to the remainder of the hierarchy. If we were to split $*?]_{\sigma}$ off from the rest of the hierarchy, candidate (b) would win. The actual surface form is (a), the candidate which most closely resembles the special failed candidate (b). This outcome does not come out of the usual resolution of constraint conflict. I suggest that in this kind of ‘battle of the titans’, where a high-ranked constraint is threatened by another, a second type of resolution is possible. This resolution is a bifurcation of the constraint hierarchy at the point of conflict into two ranked modular components. One of the conflicting constraints, in this case, $*?]_{\sigma}$, is split off into the higher segment, which I will call the P1 component. The competing constraint, here ANCHOR-R, remains with the rest of the hierarchy in the P2 component. The P1 component outranks the P2 component. As the constraint that breaks into the P1 component, $*?]_{\sigma}$ triumphs in the conflict: it will be respected in all surface forms. The conflicting constraint, ANCHOR-R, loses by virtue of its domination by the P1 component: however, it gains a consolation prize. I propose that the candidate which is most harmonic with respect to the P2 hierarchy is the sympathy candidate. The high-ranked status of

ANCHOR-R within the P2 component thus enables its force to be reflected in the form of the sympathy candidate.

Let us examine the resulting organization of the grammar in (15). This shows the bifurcation of the phonological constraint hierarchy into two segments, as induced by the conflict between the undominated constraint, $*?]_{\sigma}$, and ANCHOR-R. In this tableau I have shaded the P1 component to focus on the selection of the sympathy candidate in P2. Because $*?]_{\sigma}$ has been elevated to P1 in the resolution of its conflict with ANCHOR-R, the coda constraint is the one that will be respected in the optimal output. However, it is ANCHOR-R, along with the rest of the constraint hierarchy that will determine the sympathy candidate. With the component-based organization of the constraints, P2 selects [defE?] as the sympathy candidate, because it best respects this hierarchy of constraints. This means of selecting the sympathy candidate as the most harmonic with respect to some component, I call *harmonic sympathy*.

(15) Selection of the sympathy candidate

P1 component		⊗	P2 component			
/def?/	$*?]_{\sigma}$		*COMPLEX	ANCHOR-R	MAX-IO	DEP-IO
a. defE			*!	*	*	
b. defE?	*				*	
c. def			*!	*		
d. def?	*		*!			
e. def?E				*!	*	

With the sympathy candidate identified as the one with epenthesis and no deletion, a tableau selecting the opaque optimal output can now be exhibited in (16). Since the sympathy candidate violates $*?]_{\sigma}$ in P1, it falls out of the running for the optimal output

early. Candidates (a) and (c) survive the glottal stop coda constraint and the deciding constraint is the sympathetic faith constraint, MAX- \otimes O. This chooses [deʃE] over [deʃ], because [deʃE] more closely resembles the sympathy candidate. (Note that candidate (e) from (15) is omitted here: I will return to this form presently.)

(16) Harmonic sympathy account of opacity in Tiberian Hebrew

P1			P2				
	/deʃʔ/	*ʔ]σ	MAX- \otimes O	*COMPLEX	ANCHOR-R	MAX-IO	DEP-IO
☞	a. deʃE		*		*	*	*
	b. deʃEʔ	*!					*
	c. deʃ		**!		*	*	
	d. deʃʔ	*!	*	*			

The opaque resolution of constraint conflict means weighting the losing constraint, here ANCHOR-R, so that the actual output will resemble as closely as possible the output that would have been selected if ANCHOR-R were respected. The hierarchy bifurcation is what enables selection of the sympathy candidate and it is the placement of sympathetic faith between the two opaquely interacting constraints that produces the weighting effect of the sympathy candidate in the selection of the actual output. This positioning of sympathetic faith goes hand-in-hand with the hierarchy bifurcation. The organization that I assume locates sympathetic faith in P1. P2 then functions as an embedded optimizer for the sympathy candidate, and the P1 and P2 segments together compose the phonological grammar. It should be noted that the preliminary tableau in (15) is shown separately for expository purposes only; the tableau in (16) represents the complete evaluation. This evaluation involves two optimizations, one with respect to P2 and the other with respect to

the entire hierarchy. Selection of the sympathy candidate and the optimal output is performed in parallel evaluation with a single input-output level.

In (16), the winning candidate incurs one violation with regard to MAX- σ O, since the perfectly faithful sympathy candidate cannot win. However, two other candidates incur different kinds of sympathetic faith violations. The failure of these candidates is indicative of the rankings of different sympathetic faith constraints in Tiberian Hebrew. One failed candidate, [deʃʔE], shows that MAX- σ O must be outranked by LINEARITY- σ O (McCarthy and Prince 1995: 371), which enforces consistency of precedence structure between the sympathetic candidate and the output (17). Another failed candidate, [deʃEʔE], indicates that DEP- σ O must also dominate MAX- σ O (18).

(17) LINEARITY- σ O >> MAX- σ O

	LINEARITY- σ O	MAX- σ O
a. deʃE		*
b. deʃʔE	*!	

(18) DEP- σ O >> MAX- σ O

	DEP- σ O	MAX- σ O
a. deʃE		*
b. deʃEʔE	*!	

The complete tableau with the additional Faith- σ O constraints is given in (19):

(19) Expanded Faith- \otimes O

P1				P2			
/defʔ/	*ʔ] σ	1.DEP- \otimes O 2.LIN- \otimes O	MAX- \otimes O	*COMPLEX	ANCHOR- RIGHT	MAX- IO	DEP- IO
a. defE			*		*	*	*
b. defEʔ	*!						*
c. def			**!		*	*	
d. defʔ	*!			*			
e. defʔE		*!(2)			*		*
f. defʔEʔE		*!(1)			*		**

For verification of the harmonic sympathy analysis, tableaux are exhibited in (20-21), showing that the constraint hierarchy correctly produces /melk/ \rightarrow [melEk] and /qaraʔ/ \rightarrow [qara]. (20) provides an example where the sympathetic candidate coincides with the optimal output.

(20) /melk/

P1				P2			
/melk/	*ʔ] σ	1.DEP- \otimes O 2.LIN- \otimes O	MAX- \otimes O	*COMPLEX	ANCHOR- RIGHT	MAX- IO	DEP- IO
a. melEk							*
b. melE			*!		*	*	*
c. melk			*!	*			
d. mel			*!*		*	*	

(21) /qaraʔ/

		P1			P2			
		*ʔ]σ	1.DEP-∅O 2.LIN-∅O	MAX-∅O	*COMPLEX	ANCHOR- RIGHT	MAX- IO	DEP- IO
☞	a. qara			*		*	*	
	b. qaraʔ	*!						
	c. qar			**!		*	**	
	d. qaraʔA		*!(1)			*		*

A summary of the constraint hierarchy needed for Tiberian Hebrew is given in (22):

(22) Bifurcation triggered by opaque resolution of conflict between *ʔ]σ and ANCHOR-R.

a. P1: *ʔ]σ

Sympathy. DEP-∅O. LIN-∅O >> MAX-∅O

b. P2: ANCHOR-R

Epenthesis. *COMPLEX. MAX-IO >> DEP-IO

To summarize, we have seen that the harmonic sympathy model is capable of capturing the opacity effect in Tiberian Hebrew epenthesis. This model admits a second kind of resolution of conflict between constraints. Rather than the usual domination resolution within a single module, the hierarchy may be bifurcated into two ranked components with sympathetic faith mediating between them. As a result of this split, the losing (i.e. dominated) constraint may play a special role in selecting the optimal output: it contributes to the selection of the sympathy candidate through its high-ranked status within the dominated P2 component. The sympathy candidate is the most harmonic one with respect to P2. This model thus posits opacity as induced by sensitivity to the candidate that would be optimal with respect to some component: a contiguous segment of Eval for a

language. Most commonly the hierarchy split takes place between two high-ranking constraints in the grammar. An explanation for this tendency is discussed in section 3.6.

From a broader perspective, this means for obtaining derivational opacity effects draws on an independently supported mechanism, namely ranking separate modular components of the grammar. Golston (1995) proposes that syntactic constraints outrank all phonological ones (see also Tranel 1997). This design has foundation in the proposal of standard generative theory that syntax feeds phonology (Chomsky and Halle 1968; also Chomsky 1986; but cf. the syntax-phonology interface models outlined by Nespors and Vogel 1986; Selkirk 1986; Zec and Inkelas 1990; a different organization is posited in the Lexical Phonology model, Kiparsky 1982). Structuring the grammar in this way makes the prediction that the range of word order sequences attested in language will be given by the interaction of syntactic constraints and will not be determined by phonological conditions. Phonology is expected only to play a role in word order in deciding between syntactic structures that tie with respect to syntactic constraints, a prediction that generally seems to be borne out. The proposal here is that the phonology itself can be organized into ranked components.⁷ The overall structure of the grammatical components is given in (23).

(23) Syntax >> Phonology 1 >> Phonology 2

I suggest that the default status for a grammar is for no bifurcation to exist in the phonological constraint hierarchy (this is discussed further in section 3.6); however, evidence of opacity induces a split into two ranked components mediated by sympathetic faith. The notion of harmonic sympathy then allows the most harmonic element with

⁷ A different kind of split is proposed in Lexical Phonology, e.g. Kiparsky (1982, 1985), also related work cited in Mohanan (1995).

respect to some component to influence the decision between candidates respecting the constraints of higher-ranked components.

3.3 Tuyuca

I turn now to the analysis of antagonistic transparency in nasal harmony. This analysis calls on a phonological representation that may never surface because it cannot be physically implemented. I begin this section by outlining my assumptions about phonetic versus phonological possibility, and then I go on to apply the harmonic sympathy model of derivational opacity effects to transparent segments in Tuyuca. In this account, I explore the implications of the blocking behavior of stops in suffixes for their underlying representation and the understanding of the contrasts which hold in Tuyuca.

3.3.1 Phonetic versus phonological possibility

First it is necessary to make clear my assumptions about the phonetic versus phonological admissibility of segments. Let us consider again the representation of the sympathetic candidate for this account. This representation from (4) for a hypothetical form is repeated below in (24).

(24) The representation of the sympathetic candidate
 ā r̄ ā t̄ õ
 \ \ / / /
 [+nasal]

In (24) [+nasal] has spread to every segment in the word: this is necessary to produce nasalization of the final vowel since segments cannot be skipped in spreading. The fully-spread representation posits a nasalized voiceless alveolar obstruent stop, transcribed as [t̄].

This segment combines the feature specification [+nasal] with those defining an obstruent stop, [-sonorant] and [-continuant]. As observed in section 3.1, a segment of this kind cannot be physically produced because the demands that a segment be a buccal obstruent stop and nasal cannot both be satisfied at the same time. The specific problem is that realizing the segment with a lowered velum, as required by [+nasal], prevents the build-up of pressure behind the oral closure needed to inhibit spontaneous voicing, a property required for an obstruent stop. A segment like [t̃] is thus *phonetically impossible* — understanding phonetically possible segments as those that can be *pronounced*, i.e. those that can realize the implementational requirements of all of their phonological features (after Walker and Pullum 1997). It is important to note that the phonetic impossibility of a nasalized obstruent stop does not stem from a contradiction in its *description* — it is not at once specified both [+nasal] and [-nasal] (i.e. P & $\sim P$) — the phonetic impossibility is instead a consequence of the *interpretations* of the features yielding a logical falsehood for realizable segments (following a line proposed by Walker and Pullum 1997: 3). By this, I mean that the segments described by the feature specifications [+nasal], [-sonorant], [-continuant] correspond to disjoint sets of phonetically produceable segments: no segment can be realized as nasal and at the same time be produced as an obstruent stop. These opposing realizational requirements prevent any candidate containing [t̃] from ever being selected as the optimal output.

I propose, however, that the unpronounceability of a nasalized obstruent stop does not exclude forms containing nasalized obstruents from being generated (by the function Gen, Prince and Smolensky 1993: 4) and evaluated as part of the candidate set. That is, the set of phonologically possible segments — those that are available for evaluation in the grammar — includes some segments which are not phonetically produceable. A segment like [t̃] signifies a well-formed representation: it simply is one that cannot be pronounced.

In this understanding of the dichotomy between admissible phonetic and phonological representations I follow Walker and Pullum (1997) (cf. also Walker 1996). Walker and Pullum propose that a group of phonetically impossible segments are contained in the set of phonologically well-formed segments. They suggest that the set of phonologically well-formed segments are ‘derived by closing the set of phonetically describable segments under feature-value pairing’ (for some set of phonological features) (1997: 32), while the phonetically possible segments are the subset which are realizationally possible. The set of segments produceable by Gen is thus not an infinite one, but it contains some well-formed ‘abstract’ segments that cannot be physically realized. The situation with respect to the phonetic and phonological possibility of segments described by the feature specifications [-sonorant], [+nasal], and [-continuant] is represented diagrammatically in (25). Circles A, B and C represent the sets of segments described by each of the feature specifications (a few representative segments are given for each set).

(25) Phonetic versus phonological possibility of a nasalized obstruent stop.

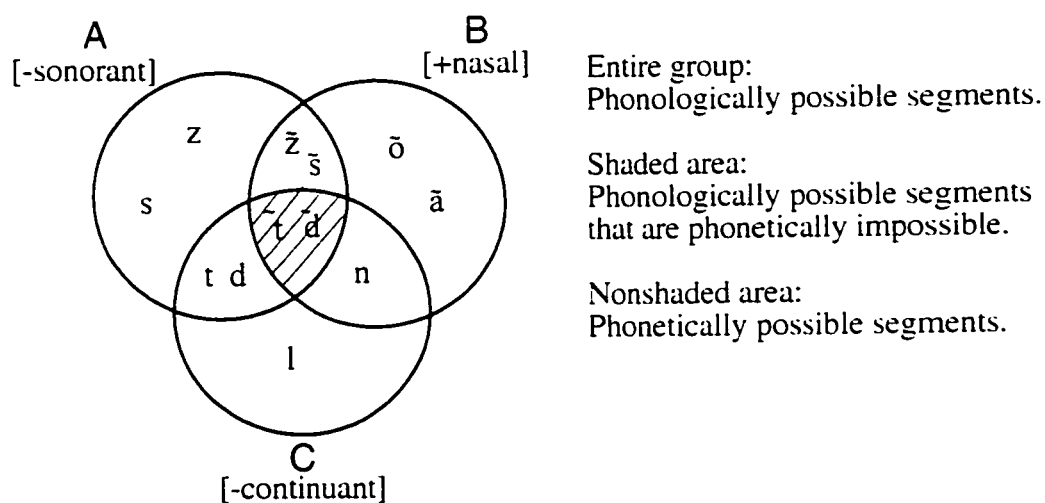

The hypothesis is that the set of phonologically possible segments describable with these features represents the union of the three sets of segments (A, B, and C) in (25). On the other hand, some of these phonologically possible segments are not phonetically possible: they do not describe segments that can be realized with the human vocal apparatus. These are the segments in the shaded portion: nasalized obstruent stops.⁸ These must be filtered out from selection by undominated feature cooccurrence constraints which rule out unpronounceable outputs.

Any analysis of a language in Optimality Theory assumes a number of undominated constraints. Some of these constraints seem to be undominated in almost every language, or perhaps even all of them (for example, FOOT-BINARITY: Prince and Smolensky 1993: 47). For constraints of this type we may question whether they belong in Gen or in the constraint hierarchy. The answer to this question has important implications for analysis. If a constraint is part of Gen, no candidates in the evaluation set can violate it. On the other hand, if a constraint is simply undominated, a candidate violating it can be compared with others, and through a sympathy correspondence relation this candidate can influence the selection of the optimal output. I will not attempt to define every constraint that must belong to Gen versus the evaluative hierarchy, but some distinctions can be made clear. First, following Prince and Smolensky (1993: 4) I assume that Gen contains information about the universal basis for phonological representations — it encodes the built-in wiring of phonological possibility. Gen includes the primitives of phonological structure, such as the set of phonological features and the levels of prosodic hierarchy, and it contains information about the elements of their organization, for example, feet are composed of syllables, not vice versa, prosodic constituents have heads, etc.. The set of candidates that

⁸ As was noted in section 2.4, the phonetic possibility of nasalized fricatives has been called into question, but there appears to be evidence for occurrences of these segments in some languages (with gradient reduction of nasalization or frication).

Gen produces is then derived by performing combinative operations on these primitives of structure and organization. In addition to faith constraints, the kinds of constraints that appear in the hierarchy evaluating these candidates are those that ban specific occurrences or configurations within the limits of organizational possibility. Examples include markedness constraints (e.g. *[+low]), cooccurrence constraints (e.g. *[+ATR, +low]), constraints on sequencing (e.g. *COMPLEX, phonotactic constraints), constraints on structural coincidence (e.g. alignment), and constraints on strict layering (e.g. PARSE- σ).

Of course any constraint that is violated in the output of *some* language must belong to the evaluative hierarchy and not to Gen, but this need not be the only criterion by which the status of a constraint be determined. I suggest that a constraint can also belong to the evaluative hierarchy even if it is unviolated in the optimal output set of *every* language. This does not in principle undermine the optimality-theoretic claim that constraints are ranked and violable. Forms violating undominated constraints will still be part of the candidate set and are evaluated along with the others. In any language, the learner discovers that certain constraints are unviolated in every optimal output: these define the undominated constraint set for that language. What I propose is that for some constraints there can never be evidence for the learner that they are violated in the optimal output. Examples of this kind will be constraints against phonetically impossible representations, such as *NASOBSSSTOP. Because this combination of features describes an unpronounceable segment, there can never be a surface form violating this constraint, although in principle this constraint could be dominated by the nasal spreading constraint. Thus nasalized obstruents are not excluded in actual surface forms because they are not possible phonological representations — these feature combinations can still be produced by Gen — rather it is a consequence of physical limitations of the vocal apparatus. This is not to say that the phonological hard wiring for segment structure is not informed by

phonetic principles. The set of phonological features itself has a phonetic basis and the unpronounceability of a nasalized obstruent stop is reflected in the phonology in being least favored in the fixed hierarchy of nasalized segments. Where phonology is distinct from phonetics is in making available all feature combinations, even those that do not correspond to the set of pronounceable segments. Other conceivable examples of phonetically impossible segments derived under exhaustive combination of feature specifications are voiced glottal stops and voiceless toned segments. Some possible cases of phonological instances of such segments that are neutralized to phonetically possible articulations in production are cited and discussed by Walker & Pullum (1997).

3.3.2 Harmonic Sympathy in Tuyuca

Because constraints against phonetically impossible feature combinations will never be violated in an optimal output, they will be posited as undominated in every learned grammar. However, given sympathy theory, there still can be evidence that these constraints are part of the evaluative hierarchy rather than Gen. This evidence comes from surface forms that could not be optimal except by a correspondence relation to a co-candidate which violates an undominated constraint in the grammar.⁹ The transparency of nasal obstruents to nasal harmony is precisely the kind of evidence needed to indicate that *NASOBSSSTOP is violable in generation of the candidate set. Let us recall the result from chapter 2 for languages with obstruent transparency. For these cases it was hypothesized that SPREAD[+nasal] outranks all nasalized segment constraints, a grammar predicted by factorial constraint ranking. When this ranking holds, the best candidate with respect to the hierarchy of phonological constraints will be the one in which [+nasal] has spread to every

⁹ It should be noted that using the form of a sympathetic candidate as evidence for whether a constraint occurs in Eval or Gen requires the assumption that any constraints have the potential to enter into an opaque interaction — an extension of the theory proposed by Ito and Mester (1997b). The original proposal by McCarthy limited sympathy candidates to ones satisfying some designated faithfulness constraint.

segment, including obstruent stops. This result from section 2.2.2 for spreading within a morpheme in Tuyuca is repeated in (26) below.

(26) Tuyuca

	wāti	SPREAD ([+nas], M)	*NAS OBSSTOP	*NAS FRIC	*NAS LIQUID	*NAS GLIDE	*NAS V	*NAS SONSTOP
☞	a. [wātĩ]		*			*	**	
	b. [wā]ti	*!*				*	*	
	c. w[ā]ti	*!***					*	
	d. [wā]t[ĩ]	*!****				*	**	

Although this constraint hierarchy selects candidate (a), containing a nasalized obstruent, this grammar could never be learned, because this output cannot be pronounced. Yet the notion of a sympathetic correspondence relation allows for a grammar which realizes an outcome as close to candidate (a) as possible. This would be an outcome like that in (d): one that is identical in all segmental properties to (a), except for the phonetically impossible nasalization on the obstruent stop. Without a sympathetic correspondence relation, candidate (d) cannot be derived. Comparing its constraint violations with those of the other phonetically-possible candidates in (26) (in (b) and (c)), we see that it incurs a superset of the constraint violations of its competitors: no reranking of these constraints can make (d) come out as optimal. Since (d) can only be selected by calling on a sympathetic candidate with full spreading, like (a), the attestation of (d) in a language provides evidence for the abstract representation in (a) as a member of the candidate set. This is assuming that there is reason to believe that an alternative full spreading co-candidate, such as [wānĩ], where /t/ becomes a sonorant, is not the sympathetic one. Evidence to this effect is discussed in section 3.3.5.

In the harmonic sympathy model, a phonetically-impossible candidate like [w̃ātĩ] will be selected as the sympathetic candidate only if it is the most harmonic candidate with respect to the P2 component. This comes about as a consequence of the resolution of two constraints vying for undominated status in Tuyuca, namely SPREAD[+nasal] and *NASOBSSTOP. The segmental markedness constraint is the one that is surface-true in the language, so it must be the winner. If this constraint conflict were resolved by ranking within the P2 component, then the resulting pattern would be one in which obstruent stops blocked spreading (see, for example, the constraint ranking needed for Applecross Gaelic in section 2.2.2). However, obstruent stops actually behave transparent in Tuyuca, so the conflict is instead resolved by promoting *NASOBSSTOP to the P1 component. Fricatives also behave transparent, indicating that a conflict between *NASFRIC and the nasal spreading constraint has also forced the fricative nasalization constraint up to P1.

A preliminary representation of the resulting grammar is given in (27). The markedness constraints against nasalized obstruents are separated into the P1 component and high-ranked constraints within the P2 hierarchy include nasal spreading and the combination of faith and markedness constraints preventing an underlying /t/ from surfacing as an [n], which I refer to here as *t→n (to be explored in the next section). Because of *t→n, the phonetically possible candidate, [w̃ānĩ], with full spreading, loses to an alternative candidate. In this tableau, constraint columns in the P1 component are shaded to focus on selection of the sympathy candidate in P2. Because the obstruent markedness constraints have been promoted to P1 and spreading is high-ranked in P2, sympathy status is assigned to the abstract candidate in (a), with full spreading.

(27) Selecting the sympathetic candidate

P1			P2				
wāti	*NAS OBSSTOP	*NAS FRIC	SPREAD ([+nas]. M)	*t→n	*NAS LIQ	*NAS GL	*NAS V
a. [wā̃tĩ]	*					*	**
b. [wā̃]ti			*!*			*	*
c. w[ā̃]ti			*!***				*
d. [wā̃]t[ī̃]			*!*****			*	**
e. [wā̃nī̃]				*!		*	**

With the sympathy candidate identified as the abstract one with full spreading, the analysis of transparent obstruents in Tuyuca can now be presented in (28). This tableau incorporates the sympathy correspondence constraint, IDENT- \otimes O, in P1. For a nasal morpheme containing a voiceless obstruent, the harmonic sympathy candidate is the abstract one in (a), with nasalization of all segments. This candidate loses on the basis of the P1 component constraint against nasalized obstruent stops. IDENT- \otimes O then acts to select the candidate of those remaining that most closely matches the content of the sympathy candidate. Candidates (d) and (e) tie on this point (insofar as this is presently an undifferentiated IDENT constraint), but (e) loses on the basis of input-output faith. (d) is thus the winner, achieving segmental transparency through its similarity to the most optimal candidate with respect to the P2 component.

(28) Transparency in Tuyuca:

P1				P2				
wāti	*NAS OBSSTOP	*NAS FRIC	IDENT - Ø O	*t→n	SPREAD ([+n]. M)	*NAS LIQ	*NAS GL	*NAS V
a. [wātĩ]	*!						*	**
b. [wā]ti			**!		**		*	*
c. w[ā]ti			**!* ⊗		***			*
d. [wā]t[ĩ]			*		*****		*	**
e. [wānĩ]			*	*!			*	**

Within this model, it is the markedness constraints against nasalized obstruents in P1 that drive the transparent outcome for these segments (the analysis of transparency proposed by Kiparsky 1981 provides foundation for this approach, see also Archangeli and Pulleyblank 1994; Pulleyblank 1996). It should be noted that the interim result from chapter 2 in which the spreading constraint outranks constraints against nasalized obstruents has been reinterpreted here in terms of an opaque resolution of these constraints. In this resolution, constraints against nasalized obstruents actually outrank nasal spreading, but nasal spreading can induce violations of nasalized obstruent constraints in the selection of the sympathy candidate. In section 3.7, I discuss a possible revised approach in which *NASOBS constraints occur in two places: undominated in P1 and dominated by spreading within P2, maintaining the result that (within P2) spreading outranks all nasalization constraints in Tuyuca.

The kind of opacity effect we are dealing with here is somewhat different from the one in Tiberian Hebrew. In derivational terms, the opacity effect in Tiberian Hebrew involves allowing some underlying structure (a glottal stop coda) to survive part-way into the derivation in order to trigger some rule (epenthesis). At the final stage of the derivation, the triggering structure is deleted. In contrast, the opacity effect in Tuyuca is of the sort realized in derivational frameworks by applying a rule to a form to derive some structure

that feeds a rule (iterative nasal spreading) and then applying another rule which changes the structure back to its original form: the so-called ‘Duke of York Gambit’ ($\alpha \rightarrow \beta \rightarrow \alpha$) (Pullum 1976). Under harmonic sympathy, Duke of York Gambit effects are possible under conditions where the constraint changing β back to α (i.e. $*\beta$) is surface-true. Markedness constraints in the P1 component correspond to surface-true neutralization rules. Shifting a markedness constraint to this higher component, allows for an output containing the banned structure to be selected as the sympathy candidate, but the supremacy of the constraint’s position enforces its satisfaction at the surface. Note that an undominated constraint remaining in the P2 component cannot produce this kind of (derivationally) opaque outcome. Undominated constraints in the P2 segment must be respected in the sympathy candidate, since it is selected on the basis of its harmonicity with respect to the P2 hierarchy. This is the usual case, and it produces transparent rather than opaque constraint interactions. I assume that the learner will posit the most transparent grammar possible to generate the forms s/he comes in contact with. This has basis in Kiparsky’s (1971, 1973) proposal that opacity effects are disfavored or ‘marked’ in grammars. Interpreted in relation to the harmonic sympathy model of opacity, this means that there will be no bifurcation in the phonology except where there is evidence to the contrary. All else being equal then, Faith- \otimes O violations and hierarchy bifurcation will be eschewed in grammar optimization.¹⁰ Note that even in a language like Tuyuca, Faith- \otimes O violations will be incurred only for nasal forms containing an obstruent stop. For all other nasal morphemes, the sympathetic form will be the same as the optimal one. This is illustrated in (29) for the form [j̃ōr̃ē] ‘little chicken’.

¹⁰ An evaluation metric for opacity effects is discussed in section 3.6.

(29) Full spreading in Tuyuca:

P1				P2					
	jōre	*NAS OBSSTOP	*NAS FRIC	IDENT - Ø O	*t→n	SPREAD ([+n], M)	*NAS LIQ	*NAS GL	*NAS V
⊗	a. [j̄ōrē]						*	*	**
	b. [j̄ō]re			*!*		**		*	*
	c. j[ō]re			*!***		***			*
	d. [j̄ō]r[ē]			*!		*****		*	**

Note that it is reasonable to ask why segmental transparency is found only with obstruents in nasal harmony and not with sonorants as well, given that it would be computationally possible to produce such effects. This question is taken up in section 3.6, where it is suggested that an evaluation metric for opaque constraint interactions in grammar offers explanation.

3.3.3 Underlying representations and contrast

As outlined in chapter 1, I follow Prince and Smolensky (1993) in assuming that inventories and contrast are emergent properties of the ranking of faith and markedness constraints.¹¹ The rankings responsible for representations and contrast in Tuyuca will make an important contribution to understanding the realization of obstruent stops under nasalization and why certain outcomes which are alternatives to transparency for voiceless obstruent stops do not occur. Recall that the consonantal inventory of Tuyuca is as follows: [p, b, t, d, k, g, m, n, ŋ, s, r, w, j, h] with nasal and voiced stops in complementary distribution as defined by nasal harmony environments (Barnes 1996).

¹¹ As noted in chapter 1, the assumption that contrast is an emergent property of faith and markedness constraint rankings is not crucial to the core of the analysis of nasal harmony. It may be that segmental contrast is best handled in an approach drawing on Dispersion theory (Flemming 1995a recasting and extending ideas of Lindblom 1986, 1990; see Steriade 1995b for related ideas; Padgett 1997 provides a recent application), but that is not an issue to be decided here.

I start with the occurrence of voiced stops and nasals in outputs of Tuyuca. It is important that we admit both of these segments as ‘phonemic’ in the language in the sense that both kinds of segments in the input will survive in the output in the general case (i.e. they are not ruled out simply by high-ranking markedness constraints). The surface complementary distribution of these segments will come about from their interaction with nasal spreading. The argument for ‘phonemic’ voiced obstruent stops in Tuyuca comes from their behavior under nasalization: voiced stops are reluctant undergoers of nasalization. This point was raised in chapter 2: in Tuyuca, voiced and voiceless stops block spreading across morpheme boundaries. This blocking pattern is a clear indication that these stops are the least compatible segments with nasalization. If the blocking voiced stops were underlyingly [+sonorant], this outcome would be unexpected, as voiced stops would then be one of the most compatible segments with nasalization and should block only when all less compatible segments do as well. I will first demonstrate how rankings of output-oriented constraints produce an inventory including both voiced obstruent stops and nasals, and then I will come back to the issue of the effect of nasal harmony on the output distribution of these segments as well as voiceless stops.

The occurrence of voiced obstruent stops in the inventory of a language is a property that emerges from ranking: the faith constraint preserving obstruency, IDENT-IO[-sonorant], must outrank the markedness constraint against voiced obstruent stops, *[+voice, -continuant, -sonorant]. The effect of this ranking for an input containing /d/ is shown in (30).

(30) IDENT-IO[-sonorant] >> * [+voice, -continuant, -sonorant]

	día	IDENT-IO[-son]	* [+voi, -cont -son]
☞	a. día		*
	b. nía	*!	

The winner in (30) is the faithful candidate in (a), which preserves the input [-sonorant] property of the stop. The claim of obstruent status is uncontroversial for voiceless stops. The ranking, IDENT-IO[-sonorant] >> * [-voice, -continuant, -sonorant], will produce the same result for voiceless stops: a voiceless obstruent stop in the input will remain an obstruent in the output. It should be noted here that I assume that there is a markedness constraint against every feature combination. The markedness constraint against voiceless obstruents will always be ranked quite low in the hierarchy of markedness constraints.

While it is clear that there are voiced and voiceless obstruent stops in the inventory of Tuyuca, there is also reason to posit nasal stops as well. It is generally recognized that nasal stops are more harmonic than voiced obstruent stops, since an open velo-pharyngeal port facilitates voicing. This suggests that the occurrence of voiced obstruent stops in an inventory should imply the presence of nasals, an implication which is almost universally true (Maddieson 1984). In addition, Ferguson (1963) notes that the presence of nasal vowels in the inventory of a language implies the occurrence of nasal stops. The inclusion of nasals in the Tuyuca inventory is obtained by the ranking in (31), which ranks the identity demand for [+sonorant] over a markedness constraint against voiced sonorant stops (I assume that some phonetically-based constraint forces these stops to be [+nasal]). The winning candidate here is (a), which preserves the input nasal stop (nasal spreading is also shown in this output).

(31) IDENT-IO[+sonorant] >> * [+voice, -continuant, +sonorant]

	nía	IDENT-IO[+son]	* [+voi, -cont, +son]
↗	a. níã		*
	b. díã	*!	

We have achieved the three series of stops in the Tuyuca inventory: voiceless, voiced, and nasal. Let us now consider the outcomes for these segments in nasal harmony. The case of a morpheme containing a nasal stop is shown in (32) for the form [mõã] 'salt'. I consider here a possible input in which the only underlying nasal segment is the nasal stop. Here the nasal stop triggers nasal spreading to all segments in the morpheme. Morphemes containing a nasal segment in the input will thus come out as nasal morphemes.¹² Identity constraints for [±sonorant] features are collapsed here and are high-ranked in P2. To simplify the tableau, constraints against nasalized obstruents are collapsed, as are ones against nasalized sonorants; also, only constraints which are immediately relevant are shown.

(32) /m/ triggers nasal spreading.

P1			P2		
moa	*NASOBS	IDENT- IO	IDENT-IO [±son]	SPREAD ([+nas], M)	*NASSON
↗	a. [mõã]				***
	b. [m]oa		*!*	**	*
	c. [mõ]a		*!	*	**
	d. boa		*!***	*	

¹² As noted in chapter 2, I assume that it is nasal segments in the first syllable that trigger nasal spreading. This will be discussed further in section 3.3.4.

In (32), the sympathetic candidate is the one which fully satisfies the nasal spreading constraint, while obeying IDENT[±son]. This chooses (a), with nasalization across the morpheme, as the sympathetic form. Because (a) does not contain any nasalized obstruents, it also is selected as the optimal output, since it best satisfies \otimes O-Faith.

Thus far we have not explored the content of the IDENT- \otimes O constraints in P1. The outcomes for obstruent stops in nasal spreading help to clarify the required ranking. First I consider the case of voiced stops. Although in isolation the ranking of IDENT[-sonorant] over *[+voice, -continuant, -sonorant] forces voiced obstruent stops in the input to be maintained as obstruents in the output, this preservation of sonorant identity can be violated in nasal morphemes, i.e. /b, d, k/ → [m, n, ŋ]. Because this outcome involves changing the [sonorant] property of the stop, it has a cost not found in the nasalization of other segments. To achieve this change in sonorancy, I suggest that sympathetic faith is capable of mapping an obstruent to a sonorant through IDENT- \otimes O[+nasal] outranking IDENT- \otimes O[-sonorant]. The outcome for a nasal morpheme containing a voiced obstruent stop is shown in (33).

(33) Realization of /d/ in a nasal morpheme.

		P1			P2			
		*NAS OBS	ID- \otimes O [+nas]	ID- \otimes O [-son]	IDENT-IO [±son]	*[+voi. -cont. -son]	SPREAD ([+n], M)	*NAS SON
33	a. [wĩnõ]			*	*			****
	b. [wĩ]do		*!*			*	**	**
	c. w[i]do		*!***			*	***	*
	d. [wĩ]d[õ]		*!			*	*****	***
	e. [wĩdõ]	*!			\otimes	*		***

Note that I assume here that /d/ → [n] takes place in the sympathy mapping, and is not achieved by nasal spreading itself, that is, for the purposes of nasal spreading, nasalization of /d/ produces a very marked segment [ḍ] rather than a very harmonic one [n]. This is to explain the fact that obstruents are reluctant undergoers of nasalization. An alternative in which nasal spreading outranks IDENT-IO[-son], giving a candidate like (a) as the sympathy candidate, is discussed (and rejected) in section 3.3.5. The tableau in (33) shows that \otimes O-Faith causes an input voiced obstruent stop to come out as a nasal stop in the output of a nasal morpheme. In an oral morpheme, the sympathy candidate will be the same as the output, and so a voiced stop will surface faithfully as an oral obstruent.

Finally, I consider the case of voiceless obstruent stops. For these segments in a nasal morpheme, the high-ranking status of IDENT[-son] in P2 will select a sympathy candidate with a nasalized voiceless obstruent stop, not one changing the voiceless stop into a nasal sonorant stop, such as [n]. IDENT[-son] thus eliminates the /t/→[n] candidate from the running for sympathy status. In the analysis of transparency for [t] in Tuyuca from (28), IDENT[-son] may be substituted for *t→n. The tableau in (34) illustrates the selection of the sympathy candidate.

(34) Selection of the sympathy candidate for /wāti/.

wāti	P1			\otimes	P2		
	*NAS OBS	ID- \otimes O [+nas]	ID- \otimes O [-son]		IDENT-IO [±son]	SPREAD ([+n], M)	*NAS SON
a.[wāṭī]	*					***	
b.[wā]ti		**			*!*	**	
c.w[ā]ti		***			*!***	*	
d.[wā]t[ī]		*			*!*****	***	
e.[wānī]			*		*!	****	

In contrast to the outcome for voiced stops in nasal morphemes, voiceless stops do not become full nasals in the optimal output. We have established that sympathetic faith can change an obstruent into a sonorant in order to preserve a [+nasal] specification: this gives [d̃] → [n]. However, a nasalized voiceless stop does not map to a voiced nasal (i.e. *[t̃] → [n]), indicating that IDENT- \otimes O[±voice] outranks IDENT- \otimes O[+nasal]:

(35) Voice specifications in sympathy candidates are preserved.

	P1					P2		
wāti	*NAS OBS	ID- \otimes O [±voi]	ID- \otimes O [+nas]	ID- \otimes O [-son]		IDENT-IO [±son]	SPREAD ([+n], M)	*NAS SON
a. [wāt̃i]	*!				\otimes			***
b. [wā̃ti]			**!				**	**
c. w[ā̃]ti			**!*				***	*
d. [wā̃]t[ĩ]			*				*****	***
e. [wā̃ñi]		*!		*		*		****

We have seen now that sympathetic faith must preserve voicing contrasts but it may change a voiced obstruent stop into a sonorant nasal. I turn now to the question of voiceless nasal outcomes for voiceless stops. Although voiced stops change to voiced nasal sonorant stops, voiceless stops do not make a parallel shift to voiceless nasals, instead they come out as voiceless oral obstruents. To understand these different resolutions, it is important to recognize that voiced nasal stops are extremely common across languages, but voiceless nasals are very marked cross-linguistically, that is, they occur only rarely in the languages of the world (Maddieson 1984, Ladefoged and Maddieson 1996). The markedness of voiceless nasals may be understood both in terms of disfavored perceptual/acoustic properties and articulatory properties of these segments. First, voicelessness in a nasal segment tends to obscure perceptual cues for place of

articulation. In acoustic studies of voiceless nasals in two South-East Asian languages, Burmese (Tibeto-Burman; Myanmar) and the Hmar dialect of Mizo (Tibeto-Burman, India), Ladefoged and Maddieson (1996: 112-3) find that voiceless nasals are actually partially voiced, with the onset of voicing beginning well before the release of oral closure. This kind of voiced period has been interpreted by various researchers as providing formant transitions to help distinguish place of articulation (Ladefoged 1971; J. Ohala 1975; Dantsuji 1986). Second, producing voicelessness in a nasal stop involves a wide-open glottis, a gesture requiring a relatively high degree of effort.

In general, the airflow through the nasal cavity that occurs during a nasal stop induces spontaneous voicing; this is why nasal stops are characterized as [+sonorant]. Because the supralaryngeal cavity configuration for sonorants produces voicing in the general case, the usual vocal cord opening for voiceless segments is insufficient to inhibit voicing in the production of voiceless sonorants, and so the vocal cords must be spread to a greater degree. Consistent with these observations, many analysts have characterized voiceless nasals (and other voiceless sonorants) as aspirated, that is, as involving a wide glottal spreading gesture (on this characterization of aspiration see Lombardi 1991 and references therein). Phonological arguments for this analysis of voiceless nasals have been made by Mester and Itô (1989, drawing partly on the phonetic description of Burmese voiceless nasals by Okell 1969), Cho (1990), Lombardi (1991, 1995c), and Steriade (1993b) (cf. Clements 1985 on voiceless laterals in Klamath). This result is also suggested by nasal airflow measurements taken in the production of Burmese voiceless nasals (Bhaskararao and Ladefoged 1991; Ladefoged and Maddieson 1996: 69, 112-113). The implication for realizing a voiceless stop as a voiceless nasal in nasal contexts is that the resulting nasal must not only be voiceless but also involve a wide glottal aperture. This kind of gesture is not common in sonorants cross-linguistically, and it does not occur in

nasals in Tuyuca. I will encode the cross-linguistic markedness of voiceless nasals with the constraint, $*N_{\bar{}}$, which prohibits voiceless nasal sonorants. In most languages, this constraint will be ranked quite high. In Tuyuca it is undominated.¹³

In Tuyuca, $*N_{\bar{}}$ actually belongs to P1 along with the nasalized obstruent constraints, because it must dominate sympathetic faith, specifically IDENT- $\text{O}[+nasal]$. This ranking is needed to ensure that a $[\bar{t}]$ in a sympathy candidate comes out as an oral $[t]$ rather than a nasal $[\bar{n}]$.¹⁴ This is illustrated in (36) (showing only immediately relevant constraints). Importantly, $*N_{\bar{}}$ rules out candidate (f), with a voiceless nasal, giving (d), with a transparent voiceless stop as the optimal output.

(36) Ruling out voiceless nasals.

		P1			P2			
wāti		1. *NASOBS 2. $*N_{\bar{}}$	ID- O [\pm voi]	ID- O [+nas]	ID- O [-son]	ID-IO [\pm son]	SPREAD ([+n], M)	*NAS SON
a.	$[\bar{w}\bar{a}\bar{t}\bar{i}]$	*!(1)						***
b.	$[\bar{w}\bar{a}]ti$			**!			**	**
c.	$w[\bar{a}]ti$			**!*			***	*
d.	$[\bar{w}\bar{a}]t[\bar{i}]$			*			*****	***
e.	$[\bar{w}\bar{a}\bar{n}\bar{i}]$		*!		*	*		****
f.	$[\bar{w}\bar{a}\bar{n}\bar{i}]$	*!(2)			*	*		****

¹³ Aspiration occurs in voiceless *obstruent* stops in Tuyuca in the environment of high vowels (Barnes and Takagi de Silzer 1976: 125-6); however, across languages aspiration of obstruent stops is a great deal more common than aspiration of nasals. Ladefoged and Maddieson (1996) note that in relation to obstruent stops, ‘aspiration’ sometimes describes a delayed timing of voice onset rather than a specific glottal aperture. Voiceless nasals, on the other hand, always require a wide glottal aperture and may or may not induce a voice onset delay. It is not clear whether aspiration of voiceless stops in Tuyuca refers to a voice timing relation or expanded glottal width. If the former, it may be that the wide glottis gesture simply does not occur in any segment in Tuyuca aside from $[h]$.

¹⁴ Alternatively, this could be handled by IDENT- $\text{O}[\pm$ aspiration], assuming that the kind of aspiration involved in voiceless nasals differs somewhat from the contextual aspiration occurring in voiceless stops in Tuyuca (see n. 13).

I conclude this section with a summary of the sympathetic faith hierarchy and contrast rankings for Tuyuca stops in (37). The stop inventory rankings admit three series of stops in Tuyuca: voiceless, voiced, and nasal. The complementary distribution of voiced obstruent stops and nasals is not attributed to any restriction on inputs or underlying representations, rather it is achieved by the ranking of constraints on outputs. These produce full [+nasal] spreading in all morphemes containing a nasal segment, and through sympathetic faith, map a nasalized voiced obstruent stop to a nasal sonorant stop. The inventory and distribution of segments in Tuyuca is thus an emergent property of the constraint hierarchy rather than based on any conditions on possible inputs.

(37) a. Stop inventory rankings:

Voiced & voiceless obstruent stops: IDENT-IO[-son] >> *[\pmvoi, -cont, -son]

Voiced nasal stops: IDENT-IO[+son] >> *[\pmvoi, -cont, +son]

b. Tuyuca sympathetic faith:

IDENT-~~IO~~[\pmvoice] >> IDENT-~~IO~~[+nasal] >> IDENT-~~IO~~[-sonorant]¹⁵

¹⁵ It should be noted that the reverse ranking of IDENT-~~IO~~[+nasal] and IDENT-~~IO~~[\pmvoice] would yield a language in which both /t/ and /d/ were realized as [n] under nasalization. This pattern is expected under factorial ranking in OT, but it is unattested. I suggest that this can be understood as a consequence of the highly neutralizing effect of such an outcome, that is, neutralization of the contrast between the series of stops in nasal morphemes in a language like Tuyuca would produce too great a reduction of their contrast potential. The notion of a threshold of neutralization of contrast potential could be understood in quantificational terms, and I leave pursuit of this matter for further research. A second prediction under sympathetic faith reranking is that /d/ could be realized as transparent [d] in the output of nasal harmony (by IDENT-~~IO~~[-sonorant] >> IDENT-~~IO~~[+nasal]). This outcome does in fact occur in the nasal harmony of Coatzacoapan Mixtec (Pike and Small 1974; Gerfen 1996). Interestingly, voiceless stops block nasal spreading in this language. The generalization seems to be that languages do not admit transparent outcomes for voiced and voiceless stops in the same language. As Walker (1996) notes, this may be best understood in terms of contrast: it is difficult to maintain a perceptible voicing contrast in oral stops between nasal vowels (see also Hayes 1995). I will not pursue this further here, but note that an account may require a more elaborated theory of contrast, such as that of Flemming (1995a; see Steriade 1995b for related ideas; also Padgett 1997).

3.3.4 Cross-morphemic spreading and fixed affixes

Next I consider the pattern of cross-morphemic spreading in Tuyuca. As outlined in 2.1, nasality spreads from the root to a set of alternating suffixes (there are no prefixes in Tuyuca). Examples of alternations with the suffix /-ri/ 'imperative of warning' are repeated below.

- (38) a. Oral suffix alternant with oral stem
 /tutí - ri/ → [tutíri] 'watch out or you will get scolded!'
 scold - imp. of warning
- b. Nasal suffix alternant with nasal stem
 /hĩĩ - ri/ → [hĩĩri] 'watch out or you will get burned!'
 burn - imp. of warning

As discussed in chapter 2, Barnes (1996) notes that alternating suffixes share a common phonological property: their initial segment is a sonorant continuant: stop- and fricative-initial suffixes always belong to the class of suffixes which are fixed in their oral/nasal quality. Voiced oral stops pattern with the obstruents in never appearing in the alternating affix category, i.e. in affixes a voiced stop/nasal stop alternation never occurs.¹⁶ Examples of obstruent-initial fixed oral suffixes are given in (39).

- (39) a. [hõõ - pi] 'at that place (over there)'
 there - locative
- b. [jũkã - da] no gloss¹⁷

¹⁶ Voiced velar stops are an exception: see discussion in n. 5 of chapter 2.

¹⁷ Barnes and Malone (1988) give the gloss for this word in Spanish as 'hilo de cumare'. 'Hilo de' means 'thread of', but I have been unable to find a translation for 'cumare'.

The phonological generalization concerning obstruents in fixed affixes is explained if obstruents block nasal spreading across morphemes. Otherwise the exclusion of obstruent-initial forms in the set of alternating affixes would be an unexplained gap. In this section I will first present an analysis of the alternating affixes, deriving the blocking effect of obstruents, and I will then go on to analyze the fixed affixes. Interestingly, we will see that the blocking outcome for obstruents in alternating affixes arises under a straightforward ranking resolution of the cross-morpheme spreading constraint and the nasal markedness constraints banning nasalized obstruents, that is, it arises when the constraint conflict is resolved with a transparent interaction by ranking without hierarchy bifurcation. In contrast, for spreading within the morpheme, the constraint conflict is resolved with an opaque interaction, producing ‘skipped’ or transparent nasalized obstruents. This makes apparent a mismatch in the common terminology: (derivationally) *opaque* constraint interactions yield *transparent* behavior of segments and (derivationally) *transparent* constraint interactions yield blocking or *opaque* behavior of segments.

The straightforward interaction of nasalized obstruent constraints with cross-morpheme spreading versus the opaque interaction with intra-morpheme spreading raises a kind of complexity in spreading and nasalized segment markedness that we have not yet considered. In order to examine its implications for the analysis, we must first determine what causes the cross-morpheme spreading. I propose that cross-morpheme spreading is driven by the word-spreading constraint in (40).

(40) SPREAD[+nasal, W]

Let f be a variable ranging over occurrences of the feature specification [+nasal], and S consist of the ordered set of segments $s_1 \dots s_k$ in a word W . Let $\text{Assoc}(f, s_i)$ mean that f is associated to s_i , where $s_i \in S$.

Then SPREAD[+nasal, W] holds iff

- i. $(\forall s_i \in S) [[\exists f (\text{Assoc}(f, s_i)) \rightarrow [(\forall s_j \in S) [\text{Assoc}(f, s_j)]]]]$.
- ii. For each feature occurrence, *f*, associated to some segment in *W*, a violation is incurred for every $s_j \in S$ for which (i) is false.

The constraint in (40) analyzes spreading across morphemes as a demand on spreading any occurrence of a [+nasal] feature to all segments within the word. In Tuyuca, the set of segments propagating nasal spreading in the morpheme (all segments) is a superset of those propagating word spreading (sonorants). For this difference in blocking effects to arise, it must be the case that the intra-morpheme spreading constraint, SPREAD[+nasal, M], outranks the cross-morpheme one, SPREAD-R[+nasal, W]:

(41) SPREAD[+nasal, M] >> SPREAD[+nasal, W]

The occurrence of blocking effects in spreading across morphemes but not within morphemes would be handled by interleaving a nasal markedness constraint between the morpheme and word spreading constraints. For example, blocking by obstruents across morphemes can be obtained with the ranking in (42). (Constraints against nasalized obstruents are collapsed as *NASOBS.)

(42) SPREAD[+nasal, M] >> *NASOBS >> SPREAD[+nasal, W]

Our reasoning has led us to the ranking in (42); however, we now face a dilemma: it was established earlier that the transparency outcome for nasalized obstruents in morphemes involves the reverse ranking of SPREAD[+nasal, M] and *NASOBS:

The issue is summarized in (45). For each of the spreading constraints, the ban on nasalized obstruents wins over perfect satisfaction of spreading. One of these constraint conflicts is resolved with a (derivationally) opaque interaction, yielding transparent or skipped obstruents, and the other is resolved with a (derivationally) transparent interaction, yielding blocking obstruents.

- (45) a. *NASOBS >> SPREAD[+nasal, M]
 Opaque constraint interaction: nasalized obstruents behave transparent
- b. *NASOBS >> SPREAD[+nasal, W]
 Transparent constraint interaction: nasalized obstruents block (in affixes)

We may note that opaque constraint interactions come about when constraints belong to separate components (i.e. segments of the constraint hierarchy) and transparent interactions occur between constraints within the same component. This means that for obstruents to block in spreading to suffixes, some constraint prohibiting the nasalization of these segments must dominate SPREAD[+nasal, W] within the same component. As shown in (44), this cannot be the general *NASOBS constraint, because we have already established that it must occur in P1. The nasalized obstruent markedness constraint in P2 must be something more specific, namely a constraint prohibiting the nasalization of obstruents in affixes.

This solution is grounded in the notion of positional markedness. The idea underlying positional markedness is that marked phonological structure may be dispreferred or excluded in prosodically or morphologically weak positions. It gives basis to work on positional licensing, which has been proposed to have applications to a wide range of phonological phenomena, spanning features, segments, syllables, and metrical structure (e.g. Itô 1986; Goldsmith 1990; Lombardi 1991; Itô and Mester 1993; Steriade

1995b, 1997; Itô, Mester, and Padgett 1995; Padgett 1995b; Zoll 1996, 1997, in press; Walker 1997b; among others; for a references to the broader range of work on the role of positional prominence in phonology, see citations in Zoll 1997). The marked phonological structures we are concerned with here are nasalized obstruents. In the sympathy candidate, word spreading can drive this kind of structure in roots but not in suffixes. This is an example of exclusion of marked segments in morphologically weak positions: affixes, which are dependent morphemes, are weaker than roots, which have the status of morphological heads. Within current optimality-theoretic work, effects of positional prominence have been implemented in two different ways: through positional markedness constraints, which enforce the coincidence of marked structure with prominent positions (Zoll 1996, 1997, in press and precursors cited above), and through positional faith, which enforce faith requirements specific to prominent positions (e.g. McCarthy and Prince 1995; Beckman 1995, 1997, 1998; Padgett 1995a; Urbanczyk 1996b; Alderete 1995, 1996, 1997a; Smith 1997; Walker 1997b; Katayama 1998).

In a careful examination of a range of positional licensing effects, Zoll presents evidence demonstrating a need for positional markedness constraints (1996, 1997, in press). Zoll (1997) focuses on two kinds of phenomena which necessitate positional markedness constraints. These are (i) the blocking of derived marked structure in weak positions, and (ii) the guiding of marked structure to strong positions. Zoll discusses the first point in relation to a licensing effect in the prosodic structure of Guugu Yimidhirr. This language is remarkable for limiting the occurrence of heavy syllables to the first two syllables, a domain which may be defined as the head (or innermost) prosodic word (P_wd) (Kager 1995). Positional markedness can explain this restriction by requiring that a heavy syllable belong to the head P_wd (or alternatively banning heavy syllables in non-head positions). Importantly, the positional markedness constraint also blocks the derivation of heavy syllables in weak positions. Guugu Yimidhirr has a suffix [-nda], which induces

lengthening of the preceding vowel when it occurs in the head Pwd. When the vowel preceding [-nda] is outside of the head Pwd, it does not lengthen. The lengthening in these cases is blocked by the constraint requiring that a heavy syllable belong to the head Pwd. Zoll points out that this outcome is not one that can be achieved with positional faith constraints. The positional faith approach to a licensing effect in the head Pwd would make use of faith constraints specific to this structural position. Ranking the position-specific faith constraint higher than non-positional faith is capable of producing various positional licensing effects; however, it cannot block the derivation of marked structure outside of the licensing position. Applied to Guugu Yimidhirr, positional faith constraints would predict that strong positions (e.g. head positions) should be more resistant to change than weak positions (e.g. non-head positions), and if strong positions can be altered to admit vowel lengthening, then weaker positions must also admit this change. However, the positional licensing effect in Guugu Yimidhirr is not of this kind, and is one that must be handled by positional markedness.

Zoll's second argument comes from the relocation of marked structure from a weak position to a strong position. She observes that a positional markedness constraint requiring that marked structure coincide with a strong position can cause marked structure to migrate from a weak position in which it originates to a strong position. This outcome retains the marked structure in the output rather than losing it all together, better satisfying MAX. Zoll shows that a phenomenon of this kind occurs in the mimetic palatalization of Japanese, described by Mester and Itô (1989). Positional faith, on the other hand, cannot explain this kind of event, because the migrating structure did not originate in a prominent position. Positional faith constraints enforce faithfulness to strong positions, and they thus resist change in these locations. It should be noted that although positional faith does not apply to these positional markedness phenomena, positional faith constraints offer explanation for other kinds of positional licensing effects. For example, positional faith

has been utilized to derive effects of triggering of spreading from strong positions and targetting of weak positions (Beckman 1995, 1997, 1998). Arguments for positional faith will be discussed later in this section.

Zoll makes a convincing case for positional markedness constraints. Her finding that only positional markedness constraints can block the derivation of marked structure in weak positions is directly relevant to the matter of obstruents blocking nasal spreading in affixes in Tuyuca. The blocking of marked structure is the kind of phenomenon we are dealing with here, i.e. we are dealing with an instance of positional markedness. To reflect the dispreference for marked material in affixes, I suggest that markedness constraints may be specific to this morphological position (Padgett 1995b makes a similar proposal for blocking formation of complex segments in affixes in Gã). The constraint against nasalized obstruents in affixes is given in (46) (cf. Zoll 1996, 1997, in press for a somewhat different formulation of positional markedness constraints).

(46) · *NASOBS_{affix}

Affix-specific markedness constraints occur in addition to the more general non-positional markedness constraints prohibiting nasalized segments. It is when these constraints are ranked separately in the grammar that asymmetries between the status of nasalized segments in roots and affixes becomes apparent.

We have seen that the non-positional markedness constraint has an opaque interaction with morpheme-domain nasal spreading: this yields transparent obstruent stops in the general case; however, in affixes there is a transparent interaction of word-domain spreading with markedness yielding obstruent blocking of nasal spread. This is achieved by placing the affix-specific markedness constraint against nasalized obstruents between morpheme and word-spreading in P2 to block nasalization of obstruents in cross-

morpheme spreading in the sympathy candidate, and by ranking the non-positional markedness constraint against nasalized obstruents in P1 to obtain full nasal spreading in all other positions in the sympathy candidate, i.e. within morphemes. The structure of the ranking is illustrated in (47–48).

The tableau in (47) illustrates selection of the sympathy candidate. Within P2, *NASOBS_{affix} outranks the cross-morpheme nasal spreading constraint, which in turn outranks constraints against nasalized sonorants. This ranking selects candidate (a) as sympathetic, where /t/ blocks spreading in the suffix. On the other hand, a root-based /t/ is nasalized in the sympathy candidate. Alternatives for the sympathy candidate lose either on the affixal markedness constraint (c) or on spreading (b, d, e).

(47) Selection of the sympathy candidate in cross-morpheme spreading

P1			P2			
āta-ta	*NASOBS	IDENT- ☉ O [+nasal]	SPREAD ([+n]. M)	*NAS OBS _{af}	SPREAD ([+n]. W)	*NAS SON
a. [ā̃tã]-ta	*				**	**
b. [ā]ta-ta		**	*!*		****	*
c. [ā̃tā̃-tā̃]	**			*!		***
d. [ā]t[ā]-ta		*	*!***		*****	**
e. [ā]t[ā]-t[ā]		*	*!*****		***** ****	***

The tableau in (48) shows selection of the actual output. This is the candidate which most closely resembles the sympathy candidate, while respecting the non-positional *NASOBS.¹⁸ Since the sympathy candidate is the one with full spreading in the root and

¹⁸ The occurrence of the non-positional *NASOBS in P1 ranked over *NASOBS_{affix} in P2 is somewhat unexpected given the positional markedness context. However, this ranking of the markedness constraints gives a positional markedness effect through the transparent interaction of *NASOBS_{affix} with spreading constraints in contrast to the opaque interaction of *NASOBS. An alternative without a positional markedness constraint and placing *NASOBS in both P1 and P2 is outlined briefly in section 3.7.

blocking by the /t/ across morphemes, the actual output is the one in (d) with an oral suffix and nasalization of all segments in the root except for [t]. Candidate (e), with nasalization of the suffix vowel, introduces nasalization in the output that is not present in the sympathetic candidate. This could be ruled out by IDENT- $\text{O}[-\text{nasal}]$ or simply by the spreading constraint, as shown here.

(48) Selection of the actual output in cross-morpheme spreading

P1		P2				
$\bar{a}ta-ta$	*NASOBS	IDENT- $\text{O} [+nasal]$	SPREAD ([+n], M)	*NAS OBS _{af}	SPREAD ([+n], W)	*NAS SON
a. [$\bar{a}\bar{t}\bar{a}$]-ta	*!				**	**
b. [\bar{a}]ta-ta		*!* *	**		****	*
c. [$\bar{a}\bar{t}\bar{a}-\bar{t}\bar{a}$]	*!* *			*		***
d. [\bar{a}]t[\bar{a}]-ta		*	****		*****	**
e. [\bar{a}]t[\bar{a}]-t[\bar{a}]		*	*****!		*****	***

To verify the analysis, I exhibit three tableaux below illustrating the analysis of cross-morpheme spreading in Tuyuca with actual forms from the language. The first example shows the blocking effect of a voiceless obstruent in spreading from a root to a suffix. In this case, with no obstruent in the root, the sympathy candidate coincides with the actual output.

(49) /hōo - pi/ 'at that place (over there)'

P1		P2				
hōo - pi	*NASOBS	IDENT- ☉ O [+nasal]	SPREAD ([+n]. M)	*NAS OBS _{af}	SPREAD ([+n]. W)	*NAS SON
a. [h̄ōō]-pi					**	***
b. h[ō]o-pi		*!*	**		****	*
c. [h̄ōō-p̄i]	*!			*		****
d. [h̄ōō]-p[ī]			*!		*****	****

Next, we see an example of a voiced obstruent blocking across morphemes.

(50) /jūka - da/

P1		P2				
jūka - da	*NASOBS	IDENT- ☉ O [+nasal]	SPREAD ([+n]. M)	*NAS OBS _{af}	SPREAD ([+n]. W)	*NAS SON
a. [j̄ūk̄ā]-da	*!				**	***
b. j[ū]ka-da		*!*	***		*****	*
c. [j̄ūk̄ā-d̄ā]	*!*			*		****
d. [j̄ūk̄ā]-d[ā]	*!		*		*****	****
e. [j̄ū]k[ā]-da		*	*****		*****	***

Finally, (51) shows nasalization across a morpheme boundary to a liquid-initial suffix.

(51) /hĩĩ - ri/ 'watch out or you will get burned!'

P1			P2			
hĩĩ - ri	*NASOBS	IDENT- OO [+nasal]	SPREAD ([+n], M)	*NAS OBS _{af}	SPREAD ([+n], W)	*NAS SON
a. [hĩĩ]-ri		*!* ⊗			**	***
b. h[ĩ]i-ri		*!***	**		****	*
c. [hĩĩ-rĩ]						*****
d. [hĩĩ]-r[ĩ]		*! ⊗	*		*****	****

We have not yet seen a case crucially calling on a distinction between morpheme-domain versus word-domain spreading. An example of this kind will be addressed in the upcoming discussion of suffixes which are fixed in their oral/nasal property.

In Tuyuca, we have seen that the interaction between *NASOBS_{affix} and nasal spreading is a transparent one, coming about from *NASOBS_{affix} dominating the nasal spreading constraint within the P2 component. Interestingly, another Tucanoan language chooses the alternative outcome for cross-morpheme spreading. The southern dialect of Barasano, a Tucanoan language spoken in Colombia, has a similar pattern of nasalization to Tuyuca (Smith and Smith 1971; Jones and Jones 1991). Like Tuyuca, Southern Barasano has nasal morphemes in which all segments are nasalized except voiceless obstruents, and nasalization spreads across morphemes to alternating affixes. There is also a set of affixes which remain fixed in their nasal quality: affixes in this set are either always oral or always nasal. Importantly, Southern Barasano differs from Tuyuca in including some obstruent-initial suffixes in its set of alternating affixes. This indicates that obstruents behave transparent in all positions. Examples of alternating affixes beginning with obstruent stops are given in (52) (data from Jones and Jones 1991).

(52) Obstruent-initial alternating affixes in Southern Barasano

a. /-ti/ 'question'

Oral alternant: /ahi - a - ti m̄/ → [ahiati m̄/ 'do you understand?'
 hear-pres.-question you

Nasal alternant: /ɲā - gu - ti j̄/ → [ɲāŋūtī j̄/ 'will I be there?'
 be-masc. sg.-question 1 sg.

b. /-b̄/ 'past nonthird person animate'

Oral alternant: /ahi - b̄ j̄/ → [ahib̄u j̄/ 'I heard'
 hear-nonthird person past 1 sg.

Nasal alternant: /ɲāŋō - b̄ j̄/ → [ɲāŋōm̄ j̄/ 'I spoke'
 talk-nonthird person past 1 sg.

In analytical terms, the difference between Tuyuca and Southern Barasano comes out as a difference in where *NASOBS_{affix} occurs in P2, as shown in (53). In Southern Barasano, *NASOBS_{affix} is dominated by the nasal word-domain spreading constraint in P2, yielding a sympathy candidate with full spreading, even across affixes. In Tuyuca, *NASOBS_{affix} outranks word spreading to give blocking by obstruents in affixes. Tuyuca thus shows an affixal positional markedness effect with respect to nasalized segments, but Southern Barasano does not.¹⁹

(53) a. *Southern Barasano*: No positional markedness effect in affixes

P1: *NASOBS >> **P2:** SPREAD([+nasal], W) >> *NASOBS_{affix}

¹⁹ The same result for Southern Barasano could be obtained by promoting *NASOBS_{affix} to P1; however, I assume that promotion of a markedness constraint to P1 is only posited by the learner when a transparent constraint interaction will not produce the correct resolution. The implications of (derivational) opacity effects for the learner are discussed in section 3.6.

b. *Tuyuca*: Positional markedness effect in affixes for nasalized obstruents.

P1: *NASOBS >> **P2:** *NASOBS_{affix} >> SPREAD([+nasal], W)

Nasalization in other Tucanoan languages also falls into one of these two patterns. *Tatuyo* (Colombia; Gomez-Imbert 1980) is of the Southern Barasano type, where obstruents can propagate nasal spreading in all positions. *Tucano* (Colombia; West and Welch 1967, 1972; Bivin 1986; Trigo 1988; Noske 1995) follows the *Tuyuca* pattern with obstruent blocking in affixes.

The next point in the analysis of cross-morpheme nasal spreading in *Tuyuca* concerns fixed affixes. As noted in section 2.1 (and repeated above), *Tuyuca* has a set of alternating suffixes and a set of suffixes which are fixed in their oral/nasal property. The alternating suffixes share the phonological property of never beginning with an obstruent (or nasal stop), as discussed above, so stop- or fricative-initial suffixes always fall in the fixed nasality category (sonorant continuant-initial suffixes may occur in either group). A partial list of *Tuyuca* suffixes grouped according to their alternating versus fixed nasality behavior is given in (54-55) (repeated from chapter 2).

(54) Alternating suffixes:

- a. -a animate plural
- b. -ha contrast
- c. -ja imperative
- d. -wi evidential
- e. -wo evidential
- f. -ri imperative of warning
- g. -re specifier

- h. -ro adverbializer
 i. -ra pl. nominative

(55) Fixed oral suffixes:

- a. -a recent past
 b. -ja evidential
 c. -wi classifier
 d. -wo classifier
 e. -ri inanimate sg. nominative
 f. -re inanimate pl. nominative
 g. -sa classifier
 h. -ba classifier
 i. -da classifier
 j. -ga evidential
 k. -go evidential
 l. -pi too much
 m. -to evidential
 n. -ka large inanimate sg.

Fixed nasal suffixes:

- o. -h̄ā emphatic
 p. -n̄ā try
 q. -w̄ĩ singularizer
 r. -w̄ō classifier
 s. -r̄ĩ time(s)
 t. -s̄ā continue action
 u. -m̄ā classifier
 v. -n̄ā at that instant
 w. -ŋ̄ā diminutive
 x. -p̄ĩ classifier
 y. -t̄ō classifier
 z. -k̄ā also

With the distribution of obstruents in this grouping explained, we might consider the possibility that fixed affixes fall into an identifiable grammatical class or later 'level' of affixation, where nasal spreading does not apply. However, this kind of approach is not tenable for the data. Barnes (1996: 34-5) notes that grammatical grounds are insufficient to predict whether a suffix will fall into the alternating or fixed nasality category. There does not appear to be a correlation between the derivational versus inflectional status of a suffix

and nasalization category; also fixed suffixes can occur before or after alternating suffixes in the linear sequence of affixes. Barnes notes that in addition to roots, aspectual and mood suffixes are always fixed in their nasality, but it is not clear whether there is any significance to the fixed nasality of aspectual and mood suffixes, and this remains an issue for further research.^{20, 21}

The occurrence of different linear orderings of fixed and alternating suffixes is illustrated in (56-57) below (data from Barnes and Malone 1988). (56a) shows an example where a nasal root is followed by a fixed oral suffix and then an alternating suffix. Here the alternating suffix comes out as oral following the fixed oral suffix. (56b) gives an oral root followed by a fixed nasal suffix and then an alternating suffix. Here the alternating suffix is nasal in the output. (I follow the descriptive notation of Barnes and Malone, using "N" for nasal morphemes, "O" for oral ones, and "[]" for morphemes that alternate in nasality. I have marked nasality on the first vowel in the input here for nasal morphemes.)

- (56) a. N O []
 | | |
 wākú - ri - wa → [wākúriwa] 'they did not think'
 think - neg. - evidential

²⁰ Barnes (personal communication 1997) notes that there does not appear to be any correlation between more 'external' suffixes and their probability of being fixed in nasality, and she reports a similar apparent lack of correlation in Tatuyo (Tucanoan). But she also points out that there is more work to be done in the investigation of this subject.

²¹ The absence of a clear grammatical category basis for the fixed nasality versus alternating status of a morpheme is consistent with the Kaye's (1971) findings concerning Desano (Tucanoan). Like Barnes, Kaye finds that major grammatical category morphemes (e.g. noun and verbs) are always fixed in their oral/nasal specification (with one exception), but suffixes are more variable. Kaye notes that one of the four participial endings is fixed and two of the three case endings are fixed. However, suffixes in other minor grammatical categories pattern together, either all being fixed in their oral/nasal property or all alternating. For example, personal endings, noun finals, and directionals all are fixed in their nasal specification, but mood markers, evidentials, and classifiers are all alternating. For those that are consistent across a minor grammatical category it is not clear whether there is a common basis distinguishing the set of categories which are fixed in nasality versus those that are alternating.

I propose to attribute the alternating versus fixed status of morphemes to differences in demands on input-output faith for the different sets of morphemes (following proposals of Itô and Mester 1995a; Pater 1995; Beckman 1995, 1997, 1998 with foundation from McCarthy and Prince 1994a, 1995). One persistent and unsurprising generalization in Tuyuca and across many of the Tucanoan languages is that roots or lexical morphemes (i.e. nouns and verbs) are fixed in their oral/nasal specification. However, the notion of 'richness of the base' (Prince and Smolensky 1993: 191), which posits that all inputs are possible, gives us the possibility that all morphemes in an input come with a specification for [\pm nasal]; it falls to the constraint hierarchy to select an outcome whereby the root specification will be preserved and spread to the suffix (restricting attention for the moment to alternating suffixes). I assume that the nasal specification for a root originates in the first syllable (see discussion in chapter 2). This outcome can be obtained by calling on positional faith constraint specific to the initial syllable of the root (after Beckman 1995, 1997, 1998; see also McCarthy and Prince 1994a, 1995 on privileged root-faith).

Beckman's (1998) study of positional privilege stands alongside Zoll's work as an important survey and analysis in the area of positional licensing effects. The focus of Beckman's work is on the role of position-sensitive faithfulness constraints in explaining a variety of positional asymmetries in phonological phenomena. A central point of her study is that root-initial syllables exhibit privilege effects and that these effects may be explained by calling on faithfulness constraints specific to this position. To establish the special status of root-initial syllables, Beckman presents evidence from both psycholinguistic and phonological domains. The psycholinguistic evidence comes from initiality effects in processing. These include the finding that utterance-initial portions make the best cues for word recognition and lexical retrieval, the special relevance of initial material for word recall in tip-of-tongue states, and the salience of mispronunciations in initial positions (see

Beckman 1998: 53 for citations of the relevant studies). Phonological evidence for a special status for the root-initial syllable comes from languages exhibiting positional neutralization of contrasts in non-initial syllables. Beckman points out that many languages with vowel harmony neutralize certain vowel contrasts outside of the root-initial syllable: this occurs frequently, for example, in languages within the Turkic, Tungusic, Mongolian, Finno-Ugric, and Bantu families (see references cited in Beckman 1998). Further, in languages that exhibit neutralization of vowel contrasts in non-initial syllables, the set of vowels occurring in non-initial positions is often a subset of the full inventory of vowels occurring in the root-initial syllable; also non-initial vowels tend to be less marked in character than root-initial ones. Beckman observes that positional neutralization effects in non-initial syllables are not limited to vowel contrasts. She documents a number of languages in which the inventory of consonants is greater in the root-initial syllable than in non-initial position.

Beckman presents an elegant account of these positional asymmetries by making use of positional faith constraints specific to the root-initial position, where the availability of this position comes from its enhanced salience in contrast to non-initial positions. The following ranking schema plays a central role in her analysis: IDENT- σ_1 [F] >> Markedness Constraint >> IDENT[F]. This ranking places faith for the root-initial position over some markedness constraint, which in turn dominates non-positional faith. As a consequence the root-initial syllable will have a privileged status not seen in non-initial syllables, whereby root-initial faith alone can enforce violations of the markedness constraint. Beckman shows that this ranking has two important consequences: (i) it yields triggering of phonological processes by the root-initial syllable, and (ii) it produces blocking of neutralizing phenomena in this position. These consequences of the ranking are exemplified by Beckman (1995, 1997, 1998) in a detailed study of positional neutralization

and harmony in the Bantu language, Shona, as well as in an analysis of the South Dravidian language, Tamil (Beckman 1998).

As noted above in the discussion of Zoll's work, positional markedness constraints are needed to explain some positional licensing effects. However, for the kinds of positional neutralization effects examined in Beckman's work, a strong case is presented for positional faith constraints for root-initial syllables. These positional faith constraints also have application to the distribution of nasalization in Tuyuca. Ranking root-initial faith constraints for [nasal] over non-positional faith constraints can produce an emergent contrast effect whereby nasality is contrastive in the initial root syllable but not elsewhere. In addition, it will derive preservation of (initial syllable) root features over affix features and will thus force nasal spreading to be triggered by a root segment.

The tableau in (59) presents a hypothetical input where a suffix belonging to the alternating class of affixes comes with a [+nasal] specification and is affixed to an underlyingly oral root. The word spreading constraint is now shown to be a rightward spreading constraint. The role of the word-spreading constraint in the analysis is to achieve spreading across morphemes, and this is always left-to-right.^{22, 23} To focus on the issue at hand, the tableau here is somewhat simplified. Only candidates containing sonorants in the relevant contexts will be considered; this means that matters of segmental transparency will not arise, so sympathy and the P1/P2 split are not shown. Sonorant nasalization constraints are collapsed (*NASSON). The constraint IDENT σ 1-IO_{root}[\pm nasal] demands

²² Note that when an alternating affix is flanked by two fixed morphemes, the left of which is the root, the agreement of the alternating affix with the root rather than the following affix cannot be derived from a Faith Root >> Faith Affix ranking (McCarthy and Prince 1994a, 1995), since either outcome respects Root Faith.

²³ Kaye (1971: 41) notes a few forms in Desano where spreading is leftward to an alternating suffix from a following fixed suffix. In these cases, he proposes that the alternating and fixed affix form a constituent in the word structure independent from one containing the root. It is not apparent whether the same phenomenon occurs in Tuyuca, but if it does, it could be analyzed structurally along similar lines. It is conceivable that further analysis of the word constituency structure in Tucanoan may prove to obviate the need for stipulating directionality in cross-morpheme spreading.

identity of [nasal] feature specifications for correspondent segments in the first syllable of the root, and IDENT-IO[±nasal] expresses the same requirement for correspondent segments in any position. Since nasality is a phonemic contrast in the first syllable but not elsewhere, IDENT σ 1-IO_{root}[±nasal] will outrank *NASSON (and spreading for cases in which word-spreading is incomplete), and *NASSON will in turn dominate the non-positional IDENT-IO[+nasal]. In (59) this ranking causes a suffix specified as [+nasal] in the input to lose this specification in the output and surface as oral.

(59) Emergent neutralization of nasal contrast in alternating affixes

	wia - rĩ	IDENT σ 1-IO _{rt} [±nasal]	SPREAD-R ([+nas], W)	*NASSON	IDENT-IO [+nasal]
↳	a. wia-ri				*
	b. wia-[rĩ]			*!*	
	c. [wĩã-rĩ]	*!*		*****	

Note that suffixes beginning in a nasal stops never exhibit nasality alternations. In these cases, the failure of the suffix to become oral after an oral root may be explained by IDENT-IO[+sonorant] dominating the spreading constraint. This prevents a nasal stop from changing to an oral voiced obstruent, as shown in (60) for a possible input for [hoá - mãĩ - ri - ga] 'I can't (do not know the way) to leave the clearing' (Barnes 1996: 42). This form contains an oral root followed by a nasal suffix followed by two fixed oral suffixes. In this tableau I only consider candidates with nasal spreading within fixed morphemes; the blocking of spreading across fixed suffixes is discussed below. I also abstract away from transparency, showing [s] as nasalized in the output.

(60) Nasal-stop initial affixes remain nasal

	IDENT σ 1-IO _{rt} [±nasal]	IDENT-IO [±son]	SPREAD-R ([+n], W)	*NASSON	IDENT-IO [+nasal]
hoa - masi - ri - ga					
a.hoa-māšī-ri-ga			****	***	
b.hoa-basi-ri-ga		*!			*

The tableau in (61) shows a hypothetical case where the first syllable of the root is [+nasal] in the input and the suffix is [-nasal]. The ranking of IDENT σ 1-IO_{root}[±nasal] over *NASSON will preserve this input [+nasal] property and spreading will cause it to spread to other root segments and the suffix in the output. Note that because nasal spreading can produce nasalization of input oral segments in weak positions, non-positional faith for [-nasal] must be dominated by the spreading constraint.

(61) Sustained nasal contrast in initial syllable

	IDENT σ 1-IO _{rt} [+nasal]	SPREAD-R ([+nas], W)	IDENT-IO [-nasal]	*NASSON	IDENT-IO [+nasal]
īja - ri					
a.[ījā-rī]			****	*****	
b.[ījā]-ri		*!*	**	***	
c.[ī]ja-ri		*!***		*	
d.ija-ri	*!				*

Thus far we have seen that the following ranking calling on faith for the initial syllable of the root versus non-positional faith can produce the fixed property of roots versus the alternating property of affixes (with further exemplification to follow).

(62) IDENT σ 1-IO_{rt}[±nasal] >> SPREAD-R([+nasal], W) >> IDENT-IO[-nasal].

*NASSON >> IDENT-IO[+nasal]

There is a third set of morphemes that we still must consider. These are the fixed suffixes. Since it will be necessary to distinguish alternating from fixed suffixes, I will call fixed suffixes 'Class 1' and alternating ones 'Class 2'. With respect to IO-faith, fixed suffixes pattern with the roots. An input [+nasal] specification will be preserved in the output and will spread (rightward) to alternating suffixes. The distinction between Class 1 and Class 2 suffixes simply refers to the separate lists of alternating versus fixed suffixes. As discussed above, some minor grammatical categories of suffixes (e.g. aspect, mood) fall completely into one class or the other in Tucanoan, but this is not always the case. In making a distinction between faith for separate groups of affixes, I follow Itô and Mester (1995a, cf. also 1995b), who propose that faith demands are different for each of four lexical strata in the Japanese lexicon; also Pater (1995), who obtains apparent exceptionality in English stress with lexically-specific faith (see also Karvonen 1998 for an application to Finnish loanword phonology; cf. Inkelas, Orgun and Zoll 1996 for a different kind of proposal). Since the Class 1 or fixed suffixes pattern with roots with respect to their fixed nasal properties, I posit a ranking in which the nasal identity constraint for the first syllable of the Class 1 suffixes is situated in the same place as root faith. This gives the ranking in (63).²⁴

- (63) IDENT σ 1-IO π [\pm nas], IDENT σ 1-IO C_{1-af} [\pm nas] >> SPREAD-R([+nas], W) >>
IDENT-IO[-nas], *NASSON >> IDENT-IO[+nas]

This ranking reflects the fact that in Tuyuca there is a split in root versus affix faith, as seen in many languages (McCarthy and Prince 1994a, 1995; Beckman 1995, 1997, 1998; Selkirk 1995; Urbanczyk 1996b; Alderete 1996, 1997a; Walker 1997b), but also within

²⁴ The faith constraint for Class 1 suffixes must be formulated as specific to the initial syllable of the morpheme, because there are a few fixed affixes/clitics with two syllables and there is always full nasal spreading within these dependent morphemes (Barnes 1996).

affix faith there is a split: some of the affixes have been promoted with respect to faith so that they pattern with the roots.

The application of this ranking to forms containing both alternating and fixed affixes is shown in (64-66) (data from (57)). In each of these instances, it is the second morpheme which is alternating and the final one which is fixed. Here I again set aside the matter of segmental transparency, simply showing transparent obstruents as nasalized in the output, as is the case within P2. To simplify the presentation, IDENT-IO[-nasal] is not included in this or subsequent tableaux. In (64), we see evidence for the ranking of IDENT σ 1 over the spreading constraint.

(64) [mākā - ri - pi] 'to the towns'

mākā-ri-pi root C2 C1	1. IDENT σ 1-IO _{ri} [±nas] 2. IDENT σ 1-IO _{C1-af} [±nas]	SPREAD-R ([+nas], W)	*NASSON	IDENT-IO [+nasal]
a. [mākā-rī]-pi		**	*****	
b. [mākā]-ri-pi		***!*	****	
c. [mākā-rī-pī]	*!(2)		*****	
d. [mā]ka-ri-pi		***!****	**	
e. baka-ri-pi	*!(1)			**

The tableau in (65) shows a case with an alternating suffix flanked by an oral root and fixed nasal suffix. In this case, the alternating suffix agrees with the oral quality of the preceding root, not the following nasal suffix. Note that with the directional formulation of the word spreading constraint, nasal markedness constraints will prevent regressive nasal spreading from the final nasal suffix:

(65) [atí - a - wĩ̃] 'he recently came'

atí - a - wĩ̃ root C2 C1	1. IDENT σ 1-IO π [\pm nas] 2. IDENT σ 1-IO C_{1-af} [\pm nas]	SPREAD-R ([+nas], W)	*NASSON	IDENT-IO [+nasal]
a. ati-a-[wĩ̃]			**	
b. ati-[ã-wĩ̃]			***!	
c. [ãtĩ̃-ã-wĩ̃]	*!(1)		*****	

In (66) we see that even with nasalization posited on the alternating morpheme in the input, this affix will still come out as oral in the output following an oral root.

(66) [atĩ̃ - a - wĩ̃] 'he recently came'

(Hypothetical input with nasalization on alternating second morpheme)

atĩ̃ - a - wĩ̃ root C2 C1	1. IDENT σ 1-IO π [\pm nas] 2. IDENT σ 1-IO C_{1-af} [\pm nas]	SPREAD-R ([+nas], W)	*NASSON	IDENT-IO [+nasal]
a. ati-a-[wĩ̃]			**	
b. ati-[ã-wĩ̃]			***!	*
c. [ãtĩ̃-ã-wĩ̃]	*!(1)		*****	

At this point the analysis has addressed the blocking behavior of obstruents in cross-morpheme nasal spreading and the distinction between alternating suffixes versus those that are fixed in their oral/nasal property. The separate behavior of fixed or Class 1 suffixes is obtained by ranking a morpheme-class-specific faith constraint higher in the constraint hierarchy than the general faith constraint (after Pater 1995: Itô and Mester 1995a). The separate occurrences of Class 1 faith and general faith in a single constraint hierarchy is able to produce the correct output for words containing Class 1 and Class 2 affixes in any order. An interesting consequence of this ranking is that it is able to achieve the occurrence of fixed oral, fixed nasal, and alternating affixes without calling on ternary use of distinctive features. This kind of approach, specifying affixes as [+nasal], [-nasal]

or [0nasal] in the input, was proposed by Noske (1995) for Tucano suffixes in a derivational framework. Positing a Class 1-specific faith constraint in OT eliminates the need for making any crucial use of ternary [nasal] specification.

The last issue I will address in this section is the full nasal spreading within fixed suffixes. Earlier in this section, it was established that voiced obstruent stops block the spreading of nasalization across morphemes, because spreading is dominated in P2 by a positional markedness constraint prohibiting the occurrence of nasalized obstruent stops in affixes. Given this and the assumption that nasalization originates in a segment in the first syllable of a morpheme we may expect that voiced obstruent stops would not undergo nasal spreading within suffixes, either fixed or alternating, that is, they could occur in the output of an affix containing a nasal vowel. However, they do undergo nasalization in fixed nasal suffixes. Voiced oral and nasal stops in suffixes always agree with the nasality of the suffix vowel. Some examples of oral and nasal fixed suffixes with voiced stops are given in (67).

(67)	<u>Oral</u>		<u>Nasal</u>		
a.	-ba	classifier	d.	-mã	continue action
b.	-da	classifier	e.	-nã	at that instant
c.	-ga	evidential	f.	-ŋã	diminutive

If a nasal stop occurs in the input of a suffix, it will trigger nasal spreading, giving a fixed nasal suffix. For voiced obstruent stops, the descriptive generalization is that they block nasalization in spreading across morphemes, but they undergo nasal spreading originating from a tauto-morphemic nasal segment. This result actually falls out of the separate ranking of the constraints on nasal spreading within the morpheme and within the word illustrated in (47): SPREAD([+nas], M) >> *NASOBS_{affix} >> SPREAD([+nas], W).

As shown in (68), the domination of *NASOBS_{affix} by morpheme spreading predicts full spreading within morphemes, producing nasal alternants of voiced obstruent stops and transparent voiceless obstruents. Because an input [+nasal] feature specification in the first syllable can spread to a [-nasal] segment in the same syllable, including obstruents, it must be the case that IDENT σ l-IO_{Class}l-af[+nasal] outranks faith for [-nasal]. The same will hold for initial-syllable root faith. (68) shows selection of the sympathy candidate with a nasalized obstruent. The input here is a hypothetical one with a nasal vowel and voiced obstruent stop in the first syllable of the fixed nasal suffix.

(68) [koa - mǎ́] ‘allow me to dig’ (selection of the sympathetic candidate)

koa - bǎ	1. ID σ l-IO _{rt} [+nas] 2. ID σ l-IO _{Cl-af} [+nas]	SPREAD ([+n], M)	1. *NASOBS _{affix} 2. ID σ l-IO _{rt} [-nas] 3. ID σ l-IO _{Cl-af} [-nas]	SPREAD-R ([+n]. W)
* a.koa-[bǎ]			** (1, 3)	
b.[kǎ̃-bǎ]	*!(1)		***** (1, 2, 3)	
c.koa-b[ǎ]		*!		
d.koa-ba	*!(2)			

The tableau in (69) shows selection of the actual output. IDENT-IO[-sonorant] is added in P2 here to select the sympathy candidate with a nasalized obstruent rather than the sonorant nasal stop, as established in 3.3.3. Reasons for rejecting an analysis with (e) as the sympathy candidate are discussed in section 3.3.5.

nasalization of sonorants, so *NASSON is ranked below spreading. Alternating (Class 2) affixes agree with the nasality of the preceding morpheme, regardless of any [nasal] feature specification they come with in the input. This is achieved by ranking the word spreading constraint over nonpositional faith, yielding the absence of a surface nasal contrast in Class 2 affixes, as well as in noninitial syllables of roots and Class 1 affixes.²⁵

3.3.5 Another abstract alternative

In this section, I return to the issue of the abstract representation called on in the sympathy candidate for obstruent stops undergoing nasal spreading. The analysis that has been developed here of transparent nasal obstruent stops in Tuyuca posits a phonetically-impossible but phonologically-accessible segment combining the feature [+nasal] with an obstruent stop [-sonorant, -continuant] (the distinction between phonological and phonetic possibility was discussed in 3.3.1). The assumption of representations with phonologically possible but highly marked nasalized obstruents has a strong motivation: *obstruents are reluctant undergoers of nasal spreading*. This reluctance is evidenced in two ways, one concerning implications when obstruents undergo nasal spreading and the other concerning implications when obstruents block. First, when obstruents become nasalized in the output (e.g. /d/ → [n]) or behave transparent, all other segments in the system also undergo nasalization: thus there are no cases of nasal harmony where nasalization spreads to vowels and voiced stops, voiceless stops behave transparent, and the remaining segments block spreading. Second, if any segments block nasal spreading, obstruent stops will be included in this group; even in a language like Tuyuca where obstruents undergo

²⁵ Since initial-syllable faith for [+nasal] outranks nasal markedness constraints for all classes of segments in P2, it will in fact be the case that any segment in the initial syllable specified as [+nasal] in the input will trigger nasal spreading; the triggers will not be limited strictly to nasal stops and vowels. In the output-centered framework of OT, this is not a problem, since the correct distribution of nasality is still achieved in the set of optimal outputs. Lexicon Optimization (Prince and Smolensky 1993; Itô, Mester, and Padgett 1995) would in any case select underlying representations of nasal morphemes with segments nasalized in the output also nasalized in the input.

nasalization (or behave transparent) within a morpheme, they still are the only segments to block nasal spread across morphemes. These points make clear that there are stops in Tuyuca which are obstruents in their underlying character (an emergent outcome derived by the rankings established in 3.3.3). Further, they support positing a sympathy candidate containing nasalized obstruent stops rather than nasal sonorant stops, because this representation reflects the markedness of nasalizing these segments.

It is possible, however, to construct an account of nasal spreading if we assume that nasalized obstruents are not well-formed representations and are never accessible. The sympathy candidate for a nasal morpheme with an obstruent stop would then contain a nasal sonorant rather than a nasal obstruent. In 3.3.3, a high-ranked constraint in P2, IDENT-IO[-sonorant], forced the sympathy candidate to choose an obstruent over a sonorant stop. If this constraint were dominated by the morpheme spreading constraint, then we could produce the effect of /t/ → [ŋ] and /d/ → [n] in the sympathy candidate. This is illustrated in (71) for a nasal morpheme with a medial voiceless stop.

(71) /t/ → [ŋ] in the sympathy candidate

P1				P2		
wāti	*N _o	ID-⊗O [±voi]	ID-⊗O [+nas]	SPREAD ([+nas], M)	1. ID-IO[-son] 2. ID-IO[±voi]	*NASSON
a. [wāŋi]	*!				*(1)	****
b. [wā]ti			**!	**		**
c. w[ā]ti			**!* ⊗	***		*
d. [wā]t[i]			*	*****		***
e. [wāni]		*!			** (1, 2)	****

It should be noted that like the nasalized obstruent analysis, this account makes use of an abstract representation, that is, it calls on a sympathy candidate which contains a segment [ŋ] that never occurs as an output correspondent for /t/ in the language.

The tableau in (72) shows the case of a nasal morpheme with a medial voiced stop. Here the sympathy candidate coincides with the actual output.

(72) /d/ → [n] in the sympathy candidate

P1				P2		
wĩdo	*N	ID- ∅ O [±voi]	ID- ∅ O [+nas]	SPREAD ([+nas], M)	1. ID-IO[-son] 2. ID-IO[±voi]	*NASSON
a. [wĩnõ]					*(1)	****
b. [wĩ]do			*!*	**		**
c. w[i]do			*!***	***		*
d. [wĩ]d[õ]			*!	*****		***

The above tableaux show that there is a ranking which is capable of analyzing nasal harmony without calling on phonetically-impossible representations. The question is should we call on this ranking? The answer seems to be no. If we call on rankings like the above, an overgeneration problem arises: we predict the possibility of a language where voiceless stops behave transparent and voiced stops become nasalized when other segments block spreading — an unattested pattern. This is produced under a ranking where some nasalization constraints dominate spreading, as shown below with a hypothetical form where [d] undergoes nasal spreading and [l] blocks.

(73) /d/ undergoes but /l/ blocks in nasal spreading: an unattested outcome

P1			P2			
ādala	*N _j	ID- O [+nas]	*NASFR *NASLQ	SPREAD ([+n], M)	1.ID-IO[-son] 2.ID-IO[±voi]	*NASGL *NASV *NASSONSTOP
a.[ā]dala		*!*		****		*
b.[ā]d[ā]la		*!		*****		**
c.[ā]d[ā]l[ā]		*!		***** ****		***
d.[ānā]la				**	*(1)	***
e.[ānā]lā			*!		*(1)	****
f.[ā]d[ā]lā		*!	*	*****		***

The problem is that if obstruent stops (e.g. [t, d]) can correspond to nasal stops (e.g. [n]) in a sympathy candidate, violating only a low-ranked nasalization constraint, their reluctance to undergo (or behave transparent) is lost. This does not arise under the account making reference to nasalized obstruents. Under one scenario with nasalized obstruents, *NASOBSSTOP will be top-ranked in P2, producing blocking by obstruent stops. Under another, the sympathy candidate will contain a nasalized stop, violating *NASOBSSTOP in P1, and this configuration only comes about when spreading dominates all lower-ranked nasalization constraints occurring in P2. The reason for this is that the promotion of *NASOBSSTOP to P1 comes about as a resolution of the conflict between the nasal markedness constraint and SPREAD([+nas], M), and I assume that the promotion arises as an alternative outcome when SPREAD([+nas], M) threatens to dominate *NASOBSSTOP. In order for SPREAD([+nas], M) to be in a position to potentially outrank *NASOBSSTOP, it must dominate the lower nasalization constraints in the hierarchy within P2.

We have seen that there is good reason to call on the representation of nasalized obstruent stops. This captures the hierarchical implications for nasalization of stops in nasal harmony. In addition, under the null hypothesis, the possibility of this analysis is

given to us by the theory. Optimality-theoretic constraints are posited as violable. Given that all of the other nasalized segment constraints are violable in various languages, we expect that representations violating *NASOBSSTOP should be called on in some language as well. The analysis we need is thus available to us, but now we are faced with explaining why a language with a hierarchy like that in (73) does not occur. A key element of this hierarchy is that spreading dominates IDENT-IO[-sonorant]. This ranking enables correspondence between obstruent stops in the input and sonorant nasal stops in the sympathetic output. To rule this out, I suggest that there is an overriding ranking structure for nasal harmony:

(74) IDENT-IO[-sonorant] >> SPREAD[+nasal]

This ranking would prevent nasal spreading from changing underlying [-sonorant] specifications. The consequence would be that only sympathetic faith could induce changes in underlying obstruency. The undesirable alternative would then be ruled out, because underlying obstruents could not correspond to sonorants in the sympathy candidate; they would have to become nasalized obstruents or block. The fact that nasal spreading cannot induce violation of [-sonorant] identity presently has the status of a stipulation in the analysis required to capture the descriptive generalization. Further research must be done to better understand the motivation for this outcome.

3.4 Some points of comparison between harmonic and constraint-based sympathy

In section 3.2 I presented an account of opacity in ?-deletion and epenthesis in the model of harmonic sympathy. This account followed that of McCarthy (1997) in most of the particulars of constraint ranking and in employing the basic mechanism of sympathy.

Where the two accounts differ is primarily in the means of selection of the sympathy candidate. In this section I briefly review a version of McCarthy's 'constraint-based sympathy' method of identifying the sympathy candidate. I suggest that harmonic sympathy explicates selection of the sympathy candidate by connecting it more closely to the kinds of evaluative mechanisms that are independently-motivated in Optimality Theory. In addition, I show that harmonic sympathy brings new understanding to a set of undesirable (derivational) opacity effects which the 'constraint-based' model is capable of generating.

McCarthy's sympathy-based account of Tiberian Hebrew is a landmark in the analysis of opacity effects in OT, bringing an illuminating new perspective to these kinds of phenomena. In what follows, I summarize how selection of the sympathy candidate takes place in Tiberian Hebrew under the constraint-based sympathy approach. The problem presented by a transparent approach to the Tiberian problem is repeated below:

(75) Incorrect outcome for /deʃʔ/ under a transparent account:

	/deʃʔ/	1. *ʔ]σ 2. *COMPLEX	ANCHOR-R	MAX-IO	DEP-IO
	a. deʃʔ	*!(1, 2)			
(⊗)	b. deʃEʔ	*!(1)			*
⌈⌋	c. deʃE		*	*!	*
⌈⌋	d. deʃʔE		*		*
	e. deʃ		*	*!	

The winner under this ranking is candidate (d); however this does not correspond to the attested form in Hebrew. The attested form, in (c), incurs a superset of the violations that (d) does, so no reranking of the constraints will serve to select (c) over (d). The solution

(following McCarthy) is to designate candidate (b) as sympathetic and then select (c) by virtue of its resemblance to (b).

Under the harmonic sympathy account, this situation is resolved by bifurcating the hierarchy so that $*?]_{\sigma}$ belongs to the P1 component. The sympathy candidate is then selected by being the most harmonic with respect to the P2 constraint hierarchy. In McCarthy's original approach, he notes that of the candidates respecting ANCHOR-R,²⁶ candidate (b) is the most harmonic, and he proposes to single out the sympathy candidate on this basis. McCarthy suggests that the sympathetic candidate is identified by being the most harmonic of the set of candidates satisfying some designated 'sympathy constraint'. Opacity effects arise when the sympathetic candidate fails as the actual output by incurring a violation of some constraint dominating the sympathy constraint. Selection of the sympathy candidate with a designated sympathy constraint is illustrated in (76). The sympathy status of ANCHOR-R is signified by the raised '⊗' symbol. Constraint rows for candidates violating this constraint are shaded: the most harmonic of the remaining candidates is the sympathy candidate.

(76) Selection of the sympathy candidate by designated sympathy constraint:

/defʔ/	1. $*?]_{\sigma}$ 2. *COMPLEX	ANCHOR-R [⊗]	MAX-IO	DEP-IO
a. defʔ	**!(1, 2)			
⊗ b. defʔE?	* (1)			*
c. defʔE		*	*	*
d. defʔE		*		*
e. def		*	*	

²⁶ McCarthy formulates ANCHOR-R as an IO right-alignment faithfulness constraint. This will be discussed presently.

The sympathy candidate loses as the actual output because of its glottal stop coda. Placing sympathetic faith constraints below $*?]_{\sigma}$ selects the correct output. As discussed in section 3.2, LINEARITY- \otimes O outranks MAX- \otimes O:

(77) Selection of the optimal output:

	/defʔ/	1.*?]_{\sigma} 2.*COMPLEX	LINEARITY- \otimes O	MAX- \otimes O	ANCHOR- RIGHT \otimes	MAX- IO	DEP- IO
	a. defʔ	*!(1, 2)		*			
\otimes	b. defʔE	*!(1)					*
\otimes	c. defʔE			*	*	*	*
	d. defʔE		*!		*		*
	e. def			**!	*	*	

McCarthy's constraint-based sympathy account provides a truly insightful account of opacity in Tiberian Hebrew. The aim of the revised harmony sympathy account is to preserve these insights, while probing the question of what engenders derivational opacity. Let us consider more generally the range of opacity effects which are predicted by constraint-based sympathy versus harmonic sympathy. McCarthy (1997) proposes to limit opacity effects under constraint-based sympathy by restricting sympathy status to the set of faithfulness constraints. In accordance with this, he formulates the designated sympathy constraint not as ANCHOR-R but as an IO faithfulness alignment constraint: ALIGN-R_{IO}(Root, σ). He notes that this restriction rules out the Optimality Theory equivalent of what Pullum (1976) calls the 'Duke of York Gambit' ($\alpha \rightarrow \beta \rightarrow \alpha$) because the sympathetic candidate can never be less faithful to the input than the actual output. However, this limitation turns out to be too restrictive. In their analysis of opacity in German truncations, Itô and Mester (1997a: 127) note that it is necessary to allow other constraints, besides faithfulness, to serve as the sympathy constraint. They find that for

German truncation, an alignment constraint must be awarded sympathy status. To this we may add that if transparent segments in spreading were to be analyzed under the constraint-based model, the spreading constraint would require sympathy status. Granting sympathy status to other constraints besides faith admits the possibility of Duke of York Gambit effects. This is a positive result in the case of transparency in spreading. In the analysis of transparency in Tuyuca nasal harmony, it was noted that it is a case of an attested opacity effect that needs to make use of a Duke of York Gambit (i.e. $t \rightarrow \bar{t} \rightarrow t$). Harmonic sympathy limits Duke of York Gambit effects to cases where the intermediate representation never surfaces in the language (or at least not in the relevant environment). The transparent behavior of segments thus adds support to Itô and Mester's finding that sympathy status must be extended to other constraints (in this case, a spreading constraint, or alternatively, another alignment constraint if this were used to drive spreading: see discussion in chapter 1). Itô and Mester further note that since assigning sympathetic status to a constraint amounts to inducing a separate optimization (in the sense of Wilson 1997) in which that constraint is top-ranked, and ranking variation amongst constraints is a basic element of OT, then 'the logic of OT itself compels us to expect other constraints in [the designated sympathy constraint] role as well' (1997a: 126-127, n. 12). For future work, they raise the important question whether any constraint can have designated sympathy status. The model of harmonic sympathy is developed in pursuit of this general issue: it attempts to bring a firmer understanding to what brings about opaque constraint interactions in grammar and the circumstances under which they occur.

Concerning what kinds of constraints may enter into opaque interactions, the harmonic sympathy model follows Itô and Mester in taking as the null hypothesis that any constraint has the potential to interact opaquely. As noted in the analysis of Tuyuca, this allows sympathetic correspondence to be used as a test for what constraints belong to Gen

and which belong to the evaluative hierarchy. Constraints belonging to Gen can never be violated in any output candidate, including the sympathy candidate, but constraints belonging to Eval can potentially be violated in the sympathy candidate, even if they are undominated and are respected in the actual output.

Although harmonic sympathy and constraint-based sympathy (as understood here) both share the assumption that any constraint can undergo an opaque interaction and are similar in several other respects (e.g. drawing on sympathetic faith), they differ in some respects in the implementation of opacity. Constraint-based sympathy attributes a privileged status to one particular constraint in narrowing the candidates that are eligible to be sympathetic. Once the candidates violating this constraint are eliminated, the constraint hierarchy chooses the most optimal of the remainder as sympathetic. Harmonic sympathy reinterprets this idea in terms of a hierarchy split as part of an opaque resolution of a conflict between two constraints. Opacity comes about when a constraint conflict is resolved with a hierarchy bifurcation at the point between the conflicting constraints. It is the high-ranking status of the constraint falling into P2 that reflects its privileged contribution to selection of the sympathy candidate, a candidate selected by optimization with respect to the dominated P2 segment of the hierarchy. Harmonic sympathy thus does not need to assign a 'sympathy' status to any particular constraint: instead it seeks to make a closer link between selection of the sympathy candidate and optimality-theoretic mechanisms, i.e. evaluation by a strictly ranked constraint hierarchy and resolution of constraint conflict by ranking. What is new under harmonic sympathy is that it allows the phonological constraint hierarchy to be organized into segments as an alternative way of resolving constraint conflict, yielding an opaque resolution of conflicting constraints. The separation of hierarchies into ranked components has independent motivation in the analysis of Syntax >> Phonology, which posits the syntactic segment of the constraint

hierarchy as dominating the phonological segment (Golston 1995; also Tranel 1997; see discussion in section 3.2) — harmonic sympathy allows for a bifurcation within Phonology.

In addition to the differences in implementation, the two models differ in some of the derivational opacity effects that they produce. In particular, the constraint-based model is capable of generating a set of unattested opacity effects that cannot be derived under the present model of harmonic sympathy. This point concerns the preservation of universal hierarchies, where ranking is fixed by a universal harmonicity scale or Meta-Constraint (Prince and Smolensky 1993; see also McCarthy and Prince 1995 on Root Faith >> Affix Faith). An example is the universal syllable peak hierarchy proposed by Prince and Smolensky (1993: 134); this ranks constraints against specific segmental syllable peaks according to their sonority. It is partially represented below:

(78) *P/t >> *P/d >> *P/n >> *P/i >> *P/e >> *P/a

The fixed ranking of these constraints encodes the universal preference for a more sonorous segment as a syllable peak over a less sonorous one. However, by assigning sympathy status to one of the lower ranked constraints in this hierarchy, constraint-based sympathy is able to subvert the implication the hierarchy is intended to capture. For example, assigning sympathy status to *P/i while ranking Faith-~~IO~~ over DEP-IO results in epenthesis of a vowel to make /i/ a margin rather than a peak, as shown in (79).

(79) /i/ must be a margin

tadi	MAX-IO *P/t *P/d	Faith- IO	DEP-IO	*P/n	*P/i IO	*P/e *P/a
.ta.di.		*!			*	*
IO .ta.dAj.			*			**

However, ranking DEP-IO over peak constraints dominating *P/i results in segments less sonorous than [i] as peaks:

(80) /n/ can be syllabic:

tadn	Max-IO *P/t *P/d	Faith- IO	Dep-IO	*P/n	*P/i IO	*P/e *P/a
IO .ta.dn.				*		*
.ta.dAn.		*!	*			**

This kind of use of constraint-based sympathy in relation to a markedness hierarchy singles out one constraint to behave as if it had undominated status in selection of the sympathy candidate, even though it may be low-ranked in the hierarchy. In the harmonic sympathy model this type of effect cannot be achieved, because harmonic sympathy maintains the ranking of a markedness hierarchy by employing a continuous segment within the overall constraint hierarchy to identify the sympathy candidate. The effects of universal hierarchies will thus be preserved.

A second case derivable under constraint-based sympathy is also worth considering. This example could be classified as involving a type of Duke of York Gambit. In this instance, a segmental markedness constraint, *p, is designated as sympathetic, so as to render it effectively invisible to conditions on syllable structure. In derivational terms, it is as if [p] is 'turned off' (i.e. deleted or extrasyllabic) at some stage

of the derivation and then later turned back on again. A ranking producing this result is as follows. Consider a language which forbids complex syllable margins. It resolves inputs with such a structure by epenthesis of a vowel. This outcome is produced by the following ranking:

(81) Epenthesis to avoid complex syllable margins:

MAX-IO, *COMPLEX >> DEP-IO

/tark/	MAX-IO	*COMPLEX	DEP-IO
a. tar k			*
b. tar	*!		
c. tark		*!	

Suppose that the markedness constraint, *p, was assigned sympathy status. Since [p] occurs freely in words of the language, MAX-IO must dominate *p. However, the sympathy status of *p will serve to select candidates without [p] as the sympathy form. Selection of the sympathetic co-candidate for a word containing /p/ is illustrated in (82). A column containing other segmental markedness constraints, *k and *r, is added here for comparison.

(82) *p as the sympathy constraint:

/tarp/	MAX-IO	*p [☺]	*r, *k	*COMPLEX	DEP-IO
a. tar p		*	*		*
b. tarp		*	*	*	
c. tar	*		*		
d. ta	**!				

Ranking DEP- \otimes O below MAX-IO will now select as optimal the candidate satisfying MAX which most closely resembles the sympathy form. For an input like /tarp/, this will be the completely faithful output, even though it violates *COMPLEX.

(83) Selecting the actual output:

/tarp/	MAX-IO	DEP- \otimes O	*p \otimes	*r, *k	*COMPLEX	DEP-IO
a. tarIp		**!	* * *			*
b. tarp		*	* * *		*	
c. tar	*!			*		
d. ta	*!*					

In contrast, coda clusters that do not contain [p] will be unaffected by the derivational opacity effect: they will be resolved by epenthesis:

(84) Forms not containing [p] are unaffected:

/tark/	MAX-IO	DEP- \otimes O	*p \otimes	*r, *k	*COMPLEX	DEP-IO
a. tarIk				**		*
b. tar	*!			*		
c. tark				**	*!	

Because the constraint-based model can potentially single out any constraint for sympathy status, it is capable of producing this segment-specific exceptionality to general phonological phenomena in the language. This seems to be a power that would best be eschewed.

In this respect, the present model of harmonic sympathy is distinct from constraint-based sympathy: harmonic sympathy cannot derive the segment-specific invisibility of the sort derived above. If we attempt to reproduce this effect under harmonic sympathy, we

must invoke a constraint hierarchy bifurcation between MAX-IO and *p, with MAX moving into the P1 component. As in the ranking under constraint-based sympathy, this means that MAX-IO will be respected in the actual output and *p will contribute to selection of the sympathy candidate. However, harmonic sympathy does not actually designate *p as special in determining the sympathy candidate: this role is played by the entire P2 hierarchy. With MAX-IO out of the picture in P2, all of the segmental markedness constraints will contribute to selection of the sympathy form. This results in an 'emergence of the unmarked' (McCarthy and Prince 1994b): the sympathetic candidate will be of unmarked shape, e.g. always a CV syllable.²⁷

(85) /tarp/: Selection of the sympathy candidate

P1		P2			
/tarp/	MAX-IO	*p	*k. *r	*COMPLEX	DEP-IO
a. tarIp		*(!)	*(!)		*
b. tarp		*(!)	*(!)	*(!)	
c. tar	*		*!		
d. ta	**				

(86) /tark/: Selection of the sympathy candidate

P1		P2			
/tark/	MAX-IO	*p	*k. *r	*COMPLEX	DEP-IO
a. tarIk			*!*		*
b. tark			*(!)*	*(!)	
c. tak	*		*!		
d. ta	**				

²⁷ I assume here that a high-ranked REALIZEMORPH in P2 rules out the null parse alternative.

MAX-IO and sympathetic faith will now select the completely faithful output in both cases. Epenthesis into coda clusters will simply never take place.

(87) /tarp/: Selection of the optimal output

P1			P2			
/tarp/	MAX-IO	DEP- IO	*p	*k, *r	*COMPLEX	DEP-IO
a. tarIp		**!	*	*		*
b. tarp		*	*	*	*	
c. tar	*!			*		
d. ta	*!* ☞					

(88) /tark/: Selection of the optimal output

P1			P2			
/tark/	MAX-IO	DEP- IO	*p	*k, *r	*COMPLEX	DEP-IO
a. tarIk		**!		**		*
b. tark		*		**	*	
c. tak	*!			*		
d. ta	*!* ☞					

The above has shown that opacity induced by a conflict between MAX-IO and *p cannot produce the effect of p-specific intermediate invisibility if MAX-IO is promoted to P1. The alternative resolution would be to promote *p to P1. In this case, *p would outrank MAX-IO yielding absence of [p] in all surface forms in the language. From a broader perspective, constraint-based sympathy and this model of harmonic sympathy differ in the following respect. Both models are capable of producing what may be considered Duke of York gambit effects for a specific segment, but harmonic sympathy achieves this only when that segment never surfaces in the language (or at least not in that

environment); constraint-based sympathy includes these cases as well as those in which the segment behaves invisible but does in fact surface. An example of a Duke of York gambit under surface neutralization of the intermediate segment is transparency of a segment in spreading, an attested opacity phenomenon. An example of the other kind is the p-specific invisibility to complex syllable margins, a phenomenon unlikely to occur. In terms of constraint-based sympathy, it stands as an observational generalization that various constraints may be sympathetic, such as faithfulness constraints (Tiberian Hebrew, McCarthy 1997), and alignment or spreading constraints (German, Itô and Mester 1997a; Tuyuca, this chapter), but not segment-specific constraints (e.g. *p, *P/i). Harmonic sympathy rules out the segment-specific invisibility without stipulation. On the other hand, some potential drawbacks of the current model of harmonic sympathy will be considered in section 3.7. A revised version of harmonic sympathy designed to address these drawbacks is closer to the constraint-based model and has the potential to be faced with the same overgeneration problems. It will be proposed, however, that by spelling out opaque constraint interactions in terms of ranking and constraint hierarchy segmentation, the revised version of harmonic sympathy provides a framework in which the unattested nature of certain opacity effects can be better understood.

To summarize, in this section I have considered the alternative constraint-based model for identifying sympathetic candidates. While this approach has brought important insight to our understanding of derivational opacity in Tiberian Hebrew (McCarthy 1997) and German (Itô and Mester 1997a), it is also capable of producing some undesirable opacity effects. The present model of harmonic sympathy model is thus preferable on the basis of being more restrictive, particularly with respect to preserving the generalizations captured by fixed constraint hierarchies. Another attractive feature of harmonic sympathy is that it reinterprets the ‘sympathy’ status of constraints more directly in terms of the kinds

of mechanisms that are already required in Optimality Theory, namely evaluation of candidates by strictly ranked constraint hierarchies and resolution of constraint conflict by ranking. Where it innovates is in permitting phonological constraint hierarchies to be organized into segments to produce opacity effects: it allows for an opaque resolution of a constraint conflict. Further investigation of opacity effects will surely continue to refine our understanding of the appropriately constrained means for designating a sympathetic candidate. Harmonic sympathy is a promising step in this direction. In section 3.7, I consider some further issues bearing on the comparison of harmonic and constraint-based sympathy, and I suggest a possible revision of harmonic sympathy to better incorporate some strengths of the constraint-based model.

3.5 Finnish

I now turn to a consideration of harmonic sympathy in relation to another (derivational) opacity effect, namely transparent vowels in Finnish vowel harmony. As noted in 3.1, many cases of transparent vowels in vowel harmony are clearly instances of antagonistic transparency, where the spreading feature is truly incompatible with the transparent segment. A false transparency account does not apply to these cases. The example of antagonistic transparency in vowel harmony that I will examine here comes from Finnish, a language of the Ural-Altaic family. Throughout the Ural-Altaic family, there is widespread vowel harmony for backness, rounding, and [ATR], which have been much discussed in the literature. In Finnish, it is vowel backness that spreads.

The surface vowel inventory of Finnish is given in (89) (each vowel may be long or short) (Ringen 1975; Kiparsky 1981; data taken from van der Hulst & van de Weijer 1995).

(89)		front		back
	high	i	y	u
	mid	e	ø	o
	low	æ		a

The interesting asymmetry in the Finnish inventory is the absence of back counterparts for the high and mid unrounded vowels /i/ and /e/ (*ui, *y). These two unpaired vowels are 'neutral' in the system.

Finnish exhibits a vowel harmony in which all vowels must either be front or back. This is a static generalization holding within stems. Alternations conditioned by vowel harmony are apparent in suffixes (like other Ural-Altai languages, Finnish is a suffixing language). Finnish suffixes have two alternants, and the stem selects the one agreeing with non-neutral stem vowels.

- (90) a. tyhmæ-stæ 'stupid' (ill.)
 b. tuhma-sta 'naughty' (ill.)

Suffixes containing an /i/ or /e/ do not have a back alternant, because of the absence of a back counterpart for these vowels. However, these non-alternating vowels do not determine the front-back quality of the vowel in any succeeding suffixes. Vowels in succeeding suffixes will agree with the last non-neutral vowel in the stem, so back vowels will follow /i/ and /e/ if there is a back vowel in the stem. /i/ and /e/ thus behave transparent to the harmony:

- (91) a. værttinæ-llæ-ni-hæn 'with spinning wheel. as you know'
 b. palttina-lla-ni-han 'with linen cloth. as you know'
 c. ljø-dæ-kse-ni-kø 'for me to hit'
 d. ljo-da-kse-ni-ko 'for me to create'

The analysis of nasal harmony has shown that there is good reason to believe that spreading is a strictly local phenomenon taking place only between adjacent segments. Non-local outcomes cannot be driven directly by the demand of spreading: these instead come about through an opaque constraint interaction where sympathetic faith drives an output most closely resembling the fully spread candidate in featural properties while still respecting some high-ranked segmental markedness constraint. This result can be maintained for antagonistically-transparent vowels in vowel harmony by positing an opaque resolution of the conflict between the [back] spreading constraint and segmental markedness constraints prohibiting the occurrence of the back counterparts to the transparent vowels (*u, *ɤ). In contrast to nasal harmony, transparency in vowel harmony does not arise with segments that are universally incompatible with the spreading feature: the transparent segments are typically those for which the counterparts that would be derived in vowel harmony are simply banned in the language for some reason (e.g. language-particular contrast demands). Thus, /i/ and /e/ behave transparent in Finnish simply because [u] and [ɤ] are disallowed in this particular language, although this is not because they are phonetically impossible segments to make: these segments do actually occur in some languages.

The constraint conflict that brings about the occurrence of transparent segments in Finnish is between the spreading constraint, SPREAD[±back] and the markedness constraints, *u, *ɤ (abbreviating feature cooccurrence constraints corresponding to these

segments). The markedness constraints are the ones that win in the ranking: these constraints are surface-true in the language. On the other hand, SPREAD[±back] wins in the sympathy competition. The constraint conflict is thus resolved with a hierarchy bifurcation with *u, *y advancing to P1 and SPREAD[±back] located at the top of the P2 hierarchy. The outcome is illustrated in (92-93). The spreading constraint dominates the markedness constraints against vowels that actually occur in Finnish. Also shown here is that high-ranked initial-syllable faith in P2 enforces preservation of the featural properties of the initial syllable, resulting in the initial syllable triggering spreading (after Beckman 1995, 1997, 1998). The tableau in (92) shows selection of the sympathy candidate, which is the one with full spreading from the initial syllable.

(92) Selection of the sympathy candidate (hypothetical input)

	P1		P2			
palttinæ-lla-ni-hæn	*u *y	ID-⊗O [±back]	SPREAD [±back]	Faith- σ ₁	*i, *e, *y, *u, *ø, *o, *æ, *a	Faith
a.palttina-lla-ni-han		**	*!***** *****...		*****	**
b.palttuna-lla-nu-han	**				****	****
c.pælttinæ-llæ-ni-hæn		*****		*!	*****	**

The tableau in (93) illustrates selection of the actual output. This is the candidate which most closely resembles the sympathy candidate in [±back] specifications, while still respecting the markedness constraints prohibiting [u] and [y]. This is the output in which /i/ behaves transparent.

(93) Selection of the actual output

		P1		P2			
		*u *y	ID- Ø O [±back]	SPREAD [±back]	Faith- σ ₁	*i. *e. *y. *u. *ø. *o. *æ. *a	Faith
☞	palttinæ-lla-ni-hæn						
	a.palttina-lla-ni-han		**	***** ****...		*****	**
	b.palttuuna-lla-nu-han	*!*				****	****
	c.pælttinæ-llæ-ni-hæn		***!***		*	*****	**

The above tableaux outline how the transparent vowels in vowel harmony can be analyzed as arising through an opaque constraint interaction. This simply presents an overview of the general approach; the vowel harmony of Finnish and other languages offer additional complexities which will not be examined here, although they are certainly of analytical interest. What is important about the above account is that it brings antagonistic transparency in both vowel harmony and in nasal harmony under the umbrella of the more general phonological phenomenon of derivational opacity effects. Under this approach, true transparency is not analyzed with parochial constraints specific to skipping of segments in spreading. Segmental transparency is rather one instantiation of the opacity effects that are pervasive in the phonologies of languages of the world.

3.6. An evaluation metric for opacity

I conclude this discussion by reviewing where we stand now on the subject of derivational opacity, segmental transparency and the locality of spreading. Chapter 2 presented a typological argument that feature spreading is strictly segmentally local: a unified typology with all expected hierarchical variants attested is achieved if systems with some transparent obstruents are regarded as patterns in which all segments actually undergo [nasal] spreading. This analytical step also has the important result of explaining why transparent

and target segments pattern together in implying that all segments more compatible with nasalization will also be permeated by nasalization. These typological grounds offer reason to believe that the gapped configuration is not a possible phonological representation, i.e. it may not be violated in the set of outputs that Gen produces. The universal ill-formedness of the gapped configuration is also motivated on other grounds. It has basis in the conception of each feature occurrence as corresponding to an uninterrupted gesture, with foundation in the insights of Articulatory Phonology (Browman and Goldstein 1986, 1989, 1990; Gafos 1996). It also is supported by independent work arguing for the segmentally-strict locality of feature spreading (Ní Chiosáin and Padgett 1997; cf. Gafos 1996; with foundation in analyses by Ní Chiosáin and Padgett 1993; McCarthy 1994; Padgett 1995a; Flemming 1995b; Walker and Pullum 1997; among others).

Importantly, in addition to these various motivations for rejecting a violable conception of the gapped configuration, the analysis in this chapter has laid out one more: the gapped configuration is not needed to obtain transparency of segments in spreading (see Pulleyblank 1996 for a similar argument, but with a different analysis of segmental transparency). In this chapter I have shown that segmental transparency can be achieved through a much more general device that is required for a range of phonological phenomena beyond just segmental transparency, namely derivational opacity effects. Any adequate theory of phonology must be able to produce the opacity effects which are widespread in the phonologies of the languages of the world. In analyzing segmental transparency as a derivational opacity effect, transparency is understood as one of a set of well-documented effects of this kind, not as a unique event requiring a phenomenon-specific theory.

Under the treatment of transparency as a derivational opacity effect, the notion of feature spreading as strictly local can be maintained, consistent with the findings of other work cited above. However, having achieved the effect of segmental transparency through opaque constraint interactions, we must examine how this effect of 'skipping' in spreading

is to be limited. I suggest that this limitation comes in the acquisition of the skipping effect, and two different kinds of acquisition factors come into play: one is a perception issue and the other is a complexity issue. Let us consider the matter of transparency in the case of nasal harmony. The cross-linguistic generalization is that only obstruents ever behave transparent. This is analyzed as coming about when constraints against nasalized obstruents interact opaquely with the nasal spreading constraint by occurring in the separate P1 segment. It is conceivable that more nasalized segment constraints could also be promoted to P1, for example, constraints against nasalized approximants. We may then expect all consonants to behave transparent to nasal spreading, as illustrated by the tableau in (94).

(94) Transparency of all consonants
P1

P1						P2	
ẽwala	*NAS OBSSTOP	*NAS FRIC	*NAS LIQ	*NAS GL	IDENT- ⊗ O [+nasal]	SPREAD ([+n], W)	*NAS V
a.[ẽwãĩã]			*!	*			***
b.[ẽ]wala					***!*	****	*
c.[ẽwã]l[ã]				*!	*	*****	***
d.[ẽ]w[ã]l[ã]					**	***** ****	***

Yet consider how the pronounced outputs of such a language would be perceived by the learner. An oral liquid or glide occurring between two nasal vowels would be extremely difficult to distinguish from a nasalized liquid or glide in the same context, e.g. it is difficult to perceive the difference between /ãĩã/ and /ãĩã̃/. The basis for this claim is as follows. First, unlike obstruents, approximants do not have acoustic cues of burst or frication to signal the raised status of the velum. Second, there is little auditory distinction between nasalized and non-nasalized approximants (Cohn 1993a: 362; Ladefoged and Maddieson

1996: 132). In the environment of a nasal vowel, this distinction would be minimized even further, because of the tendency for the nasalization to overlap to some degree onto the neighboring consonant (Cohn 1993a). In addition, even when oral, approximants share similar acoustic properties with nasals, namely (weak) formant structures (Ladefoged 1993; Flemming 1995a). In the case of laterals, Flemming (1995a: 11) points out that the auditory similarity between [l] and [n] actually induces substitution of [n] for /l/ in fortition environments in Korean and Cuna. Given the similarity in auditory output for oral approximants and their nasal counterparts it is reasonable for the learner to posit the most derivationally-transparent alternative as the output, i.e. the one in which the approximant actually is nasalized in the output rather than oral. This yields a grammar in which sonorants come out as targets rather than surface-transparent.

The matter of derivational-transparency leads into the second issue of acquisition, concerning the relative difficulty of learning derivational opacity. In his discussion of derivational opacity, Kiparsky (1971, 1973) suggests that opaque grammars are marked in the sense that they are harder to learn and the direction of language change will be towards derivational transparency. The sympathy account of derivational opacity lends insight to Kiparsky's claims. Under this approach to opacity effects, an opaque constraint interaction is more complex than a transparent one because it involves computing an extra evaluation or optimization of the candidates, namely the optimization that selects the sympathy candidate. A derivationally-transparent grammar makes use of just one optimization, the selection of the actual output. It is reasonable to assume that the fewer optimizations required in selecting an output, the easier the grammar is to learn.

In addition to representing the increased complexity of derivational opacity in comparison to derivational transparency, sympathetic faith also gives us a means of evaluating the degree of difficulty for learning a particular opacity effect. I suggest that the

greater the gap between the sympathetic output and the actual output, the harder the language will be to learn, that is, grammars with more sympathetic faith violations are more difficult to acquire than ones with fewer violations. Coming back to the question of nasal harmony, this means that grammars with fewer transparent segments will be easier to learn. A language in which all consonants behaved transparent would thus be difficult to acquire not only from the perspective of perception (as noted above), but also because of the great difference between the sympathetic output and the actual output. More generally, analyzing segmental transparency as a derivational opacity effect predicts that blocking by a segment will be a more common outcome in spreading than the segment behaving transparent, and this seems to be generally borne out (with the exception of phonetically impossible segments). This view of acquisitional difficulty provides explanation for the observation made in 3.2 that opaque interactions tend to occur between high-ranked constraints, for example, between two constraints that are competing for undominated status. The tendency for opacity to come about in a 'battle of the titans' rather than in a conflict between low-ranked constraints is predicted by attributing degree of dissimilarity between the sympathy candidate and the actual output as directly correlated to the degree of difficulty for the learner. If P1 contains just one constraint, then sympathetic faith violations can be induced only by the single P1 constraint. As more constraints are added to P1 (corresponding to conflicts between lower-ranked constraints), the greater the potential for violations of sympathetic faith in the actual output, that is, the potential for difference between the sympathy form and real output form increases, for example in (94), the sympathy candidate can differ from the actual output in nasalization of all consonants, not just obstruents. In grammars with opacity effects, acquisitional factors will thus favor small P1 segments.

We may conclude that when faced with a choice between several alternative grammars (i.e. constraint rankings) that all produce the same correct output, the learner will

choose the grammar that minimizes opaque constraint interactions and maximizes similarity between the sympathy candidate and actual output when opacity is required. Grammar optimization thus eschews opacity.

3.7 Appendix: German and harmonic sympathy revisited

One of the breakthroughs in analysis of derivational opacity effects in Optimality Theory is the sympathy-based account of opacity in German truncation developed by Itô and Mester (1997a). Their analysis in the constraint-based model of sympathy theory is important both in the extensive insights it brings to the understanding of German phonology and in the elaboration of sympathy theory. If harmonic sympathy is to be considered a viable approach to derivational opacity, it must be able to account for the German opacity as well. In this appendix I outline a harmonic sympathy account of German truncation, following the analysis of Itô and Mester in several respects. I begin by reviewing the relevant points of the constraint-based sympathy analysis and then focus on the modifications needed to capture the facts under harmonic sympathy. I discuss a drawback of the harmonic sympathy approach raised by this account, and propose a possible revision to harmonic sympathy which brings it closer in line with constraint-based sympathy. This revised version serves as a development of constraint-based sympathy which reworks and explicates the concept of a separate optimization selecting the sympathy candidate. The implications of this revised approach for the analysis of Tuyuca and for issues of overgeneration of derivational opacity effects are briefly outlined.

German exhibits a productive pattern of truncation, deriving various kinds of shortenings including hypocoristics. Some examples are given in (95) (from Itô and Mester 1997a, see citations therein for previous analyses). In the following data, double consonants appear as an orthographic convention signifying shortness of the preceding vowel; they do not represent geminate consonants.

(95) a. Truncata maximizing sequence C_0VC_1

<i>Base</i>	<i>Truncation</i>		
Gorbatschow	Gorbi	*Gorri	(name of politician)
Hans	Hansi	*Hanni	(personal name)
Alkoholiker	Alki	*Alli	'alcoholic'
Gruft	Grufti	*Gruffi	'older person'
Hirn	Himi	*Hirri	'brain'
Imperialist	Impi	*Immi	'imperialist'
Tourist	Touri	*Toui	'tourist'
Radenković	Radi	*Rai	(well-known goalkeeper)

b. Non-maximal truncata

<i>Base</i>	<i>Truncation</i>		
Gabriele	Gabi	*Gabri	(personal name)
Andreas	Andi	*Andri	(personal name)
Dagmar	Daggi	*Dagmi	(personal name)
Heinrich	Heini	*Heinri	(personal name)
Ulrich	Ulli	*Ulri	(personal name)
Siegfried	Siggi	*Siegf(r)i	(personal name)
Klinsmann	Klinsi	*Klinsi	(name of soccer player)
Littbarski	Litti	*Littbi	(name of soccer player)
Imker	Immi	*Imki	'beekeeper'

Knoblauch Knobi *Knobli ‘garlic’

As Itô and Mester point out, the challenge presented by these data is identifying the exact shape of the truncatum (the portion copied from the base and suffixed with [-i]). The output of the truncation is always two syllables in length, and material from the base is copied from left to right to fill the first syllable and the onset to the second. The data in (95a) suggest that the copied material is always the maximal string matching the form: C_0VC_1 , i.e. *Gorbatschow* truncates to *Gorbi* not **Gorri*. However, the data in (95b) show that the medial consonant cluster is not always maximized. For example, the truncation of *Gabriele* is *Gabi* not **Gabri*. Itô and Mester make the important observation that the general form the truncations take is produced (descriptively) by suffixing [-i] to the maximum possible syllable of German derivable from the sequence of segments in the base scanned from left to right.

The German truncation facts are resistant to an account assuming only transparent constraint interaction. Itô and Mester outline a transparent approach along the following lines. First, the reduced size of the truncated form is analyzed with the ranking in (96) giving rise to an ‘emergence of the unmarked’ (McCarthy & Prince 1994b). This ranking places a size restricting constraint between input-output (IO) faith and truncation-specific base-truncatum (BT) faith.

(96) MAX-IO >> ALLFTL >> MAX-BT

The analytical assumption here is that output-output (OO) faith applies to truncation (following Benua 1997), such that identity is required between the output form of the base and the output form of the truncatum (TRUNC). The faith relations are illustrated diagrammatically in (97) (from Itô and Mester 1997a).

(97) Base-truncatum faith relations:

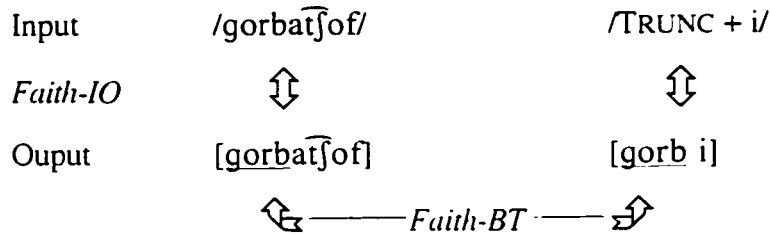

The outcome selected by the ranking in (96) is illustrated in (98). MAX-IO is relevant only for [-i] in the input, because the TRUNC portion does not have underlying segmental material. MAX-IO thus rules out candidates (e-g), in which [-i] fails to surface. MAX-BT promotes a candidate that fully copies the material in the base; however, the domination of this constraint by ALLFTL (ALIGN(foot, L, Pwd, L)), results in an output with no more than two syllables. Since the rhyme of the second syllable must be [i] (by MAX-IO), the truncatum will consist of as much material from the base as will fill the first syllable and form the maximal possible onset to the second. PARSE-σ is added here to prevent segmental material outside of the foot from surviving.

(98) Transparent account of truncation

	MAX-IO	ALLFTL	PARSE-σ	MAX-BT
Base: (.gor.ba).(t̄fof.) Input: /TRUNC - i/				
a. (.gor.ba).(t̄fo.f-i.)		*!		
b. (.gor.ba).t̄f-i.			*!	of
c. (.gor.b-i.)				at̄fof
d. (.go.r-i.)				bat̄fof!
e. (.gor.ba.)	*!			t̄fof
f. (.gorb.)	*!			at̄fof
g. (.gor.)	*!			bat̄fof

While the transparent account is successful for instances of truncation which maximize the C_0VC_1 sequence, it fails for the non-maximal cases. This is illustrated in (99) for the truncated form of *Gabriele*. Instead of selecting the desired winner (d), the maximizing effect of MAX-BT chooses (c). This undesirable outcome is signalled by the left-pointing hand.

(99) Transparent account fails

	Base: (.ga.bri).(e.le.) Input: /TRUNC - i/	MAX-IO	ALLFTL	PARSE- σ	MAX-BT
	a. (.ga.bri).(e.le).-i.		*(!)	*(!)	
	b. (.ga.bri).(e.l-i.)		*!		e
☞	c. (.ga.br-i.)				iele
☞	d. (.ga.b-i.)				riele!
	e. (.gab.)	*!			riele

The transparent account is insufficient to distinguish between the truncation of the maximizing forms in (95a) and the non-maximal ones in (95b). Itô and Mester propose instead to make use of the insight that the truncatum corresponds to the maximal possible syllable of German that can be formed by the sequence of segments in the base. To do this, they call on a sympathy candidate which consists of precisely this form. This candidate is identified by assigning sympathetic status to an alignment constraint: ALL σ L (ALIGN(σ , L, Pwd, L)). Ranking this constraint between MAX-IO and MAX-BT selects as the sympathy candidate a single syllable containing maximal material from the base. Note this does not necessarily correspond to the *actual* syllabification of this sequence of

segments in the base. Selection of the sympathy candidate is illustrated in (100). Candidates violating ALL σ L are shaded here.²⁸

(100) Selection of sympathy candidate with constraint-based sympathy

Base: .ga.bri.e.le. Input: /TRUNC - i/	MAX-IO	ALL σ L [⊗]	MAX-BT
a. .ga.bri.e.le.-i.		σσσσσσσσσσ	
b. .ga.bri.e.l-i.		σσσσσσ	e
c. .ga.br-i.		σσσ	iele
d. .ga.b-i.		σ	riele
e. .ga.-i.		σ	briele
⊗ f. .gab.	*		riele
g. .ga.	*		briele!

The candidate in (f) is the best of the candidates respecting ALL σ L, but it loses in the competition for the actual output because of its violation of MAX-IO. The actual output is the candidate which matches the segmental material in (f) with the addition of the [-i] suffix. This is achieved by ranking the sympathetic faithfulness constraint, DEP- \otimes O, below MAX-IO and above MAX-BT. The complete tableau is exhibited in (101).

²⁸ Itô and Mester (1997a, n.15) note that alternative candidates [.ai.] and [.i.] are ruled out as sympathetic on the basis of other high-ranking constraints.

(101) Constraint-based sympathy constraint account of truncation

	Base: .ga.bri.e.le. Input: /TRUNC - i/	MAX-IO	DEP- \otimes O	ALL σ L \otimes	MAX-BT
	a. .ga.bri.e.le.-i.		rieli!	$\sigma\sigma\sigma\sigma\sigma\sigma\sigma\sigma$	
	b. .ga.bri.e.l-i.		rieli!	$\sigma\sigma\sigma\sigma\sigma$	e
	c. .ga.br-i.		ri!	$\sigma\sigma\sigma$	iele
\otimes	d. .ga.b-i.		i	σ	riele
	e. .ga.-i.		i	σ	briele!
\otimes	f. .gab.	*!			riele
	g. .ga.	*!			briele

This sympathy account also achieves the correct results for a base like [gorbat]of]. In this case the sympathy candidate will be [gorb], because the consonant cluster can constitute a well-formed coda, and the actual output is the candidate adding just [-i] to this form, giving [gorbi].

Itô and Mester's sympathy-based analysis brings new understanding to the German truncation phenomenon. In this constraint-based sympathy account, the dominated alignment constraint, ALL σ L, is assigned sympathetic status, resulting in selection of the maximal monosyllabic candidate for German as the sympathy candidate. Through sympathetic correspondence, this sympathy candidate determines the amount of base material that will be copied in the truncatum. Under the harmonic sympathy model, the means of selecting the sympathy candidate is framed in a somewhat different way. The sympathetic form is one that is most harmonic with respect to a contiguous segment of a bifurcated constraint hierarchy, the hierarchy forming the P2 segment. The sympathetic candidate fails to surface itself when it violates some high-ranked constraint belonging to P1. If Itô and Mester's account were to be translated directly into this model, the P1 constraint would be MAX-IO; this is the constraint dominating ALL σ L that is violated in the sympathy candidate. However, under the faith-based conception of inventory structure

proposed by Prince and Smolensky (1993). MAX-IO is dominated by all of the markedness constraints that correspond to prohibited segments in German (e.g. *ɟ, *ʃ, *ʎ, etc.). It is conceivable that MAX-IO and all of its dominating markedness constraints could belong to P1, but this move would permit potential sympathy candidates containing the prohibited segments, a consequence that may have problematic results for other phenomena in the language. To sidestep this possibility, I will pursue an analysis in which the P1 constraint in German is not a faith constraint but rather an undominated organizational parsing constraint: PARSESEG σ , which requires that all output segments be parsed into syllables.²⁹ A segment violating this constraint will not be syllabified but it will still be pronounced, because it is contained in the output. Such a segment will be appended to prosodic structure at some higher level, such as the foot or prosodic word.³⁰ The constraint which threatens PARSESEG σ and induces the hierarchy bifurcation is an alignment constraint for the truncation suffix:

- (102) ALIGN-TO- $\acute{\sigma}$:
ALIGN([i] _{Af}, L, $\acute{\sigma}$, R).

This alignment constraint expresses the requirement that the left edge of the [-i] affix coincide with the right edge of the head syllable (denoted by $\acute{\sigma}$). This constraint is similar to the one proposed by McCarthy and Prince (1993b) for the [-ka-] possessive affix in Ulwa, which aligns the affix to the right edge of the main stress foot: ALIGN([ka] _{Af}, L, Ft', R) (on alignment to heads see also Pierrehumbert 1993b; Lorentz 1995).

²⁹ I assume that coronal voiceless fricatives occurring at the periphery of a syllable next to a stop are not extra-syllabic but are parsed into the syllable, forcing a violation of the sonority-sequencing constraint.

³⁰ A input-oriented version of this constraint was first proposed by Prince and Smolensky (1993: 85). The PARSE constraint of Prince and Smolensky functioned as a faithfulness constraint. In this respect it differs from the present PARSESEG σ constraint, which simply expresses a demand on the layering of prosodic structure in the output.

The problem that arises under a transparent interaction of PARSESEG σ and ALIGN-TO- σ is illustrated in (103).

(103) PARSESEG σ >> ALIGN([i]_{Af}, L, σ , R) >> MAX-BT

	Base: .ga.bri.e.le. Input: /TRUNC - i/	PARSE SEG σ	ALIGN-TO- σ	MAX-BT
☞	a. .ga.bi. (Optimal, opaque constraint interaction)		*	riele!
(☞)	b. .gab.<i> (Non-optimal, sympathetic)	*!		riele
☞	c. .gab.ri. (Non-optimal, transparent constraint interaction)		*	iele

The unsyllabified status of [i] in candidate (b) is signified by the angle brackets. Under a transparent constraint interaction, the candidate satisfying affix-to-head alignment loses on a PARSESEG σ violation. This turns the competition over to (a) versus (c), which both have exhaustive parsing of segments into syllables. Candidate (c) is then selected as the winner since it copies more base material than (a). However, this outcome is not the correct one for German: (a) corresponds to the actual attested form. A harmonic sympathy analysis can obtain this result by calling on a sympathetic correspondence relation between candidate (b) and the actual output. The constraint conflict here must thus not be resolved by simple ranking, but rather by a hierarchy split, so that ALIGN-TO- σ may condition selection of the sympathy candidate. We will see later in this section that this approach will have to be revised; however, I will first work out the details of this account in order to identify a shortcoming of the present model of harmonic sympathy.

In selecting the sympathy candidate, the function that ALIGN-TO- σ performs is similar to that of ALL σ L in restricting the medial consonant cluster to a possible coda of German: however, the form of the sympathy candidate is somewhat different in the two

accounts. The constraint-based sympathy analysis makes use of a truncatum-sized sympathy candidate which violates MAX-IO by failing to include the suffix [-i]. In procedural terms, this corresponds to the form that would be derived from the base by syllable circumscription before [-i] is suffixed (as noted by Itô and Mester 1997a: 125). On the other hand, the harmonic sympathy account calls on a sympathy relation to a form obeying MAX-IO. In this case the sympathy candidate contains the same segmental sequence as the output but with syllabification only of the truncatum. Serially, this loosely corresponds to the form after circumscription and i-suffixation but before resyllabification of the final string.

So far, we have determined that the harmonic sympathy account involves splitting off PARSESEG σ into P1 and assigning a high-ranked status to ALIGN-TO- σ in P2, but some further details remain. First, to obtain the minimized size in truncation, I call on an emergence of the unmarked ranking similar to that which Itô and Mester suggest for the transparent account. This sandwiches a size restrictor (here ALL σ L) between IO and BT faith: MAX-IO >> ALL σ L >> MAX-BT. Second, I note a high-ranked constraint in the P2 component which rules out various candidates for sympathy or optimal output status. This is a sonority sequencing constraint, SSC, which expresses the requirement that complex onsets rise in sonority and complex codas fall in sonority (the notion of sonority sequencing goes back to Sievers 1881; Jespersen 1904).³¹ With these rankings in place, the tableau showing selection of the sympathy candidate is exhibited in (104).

³¹ As pointed out in n. 29, this constraint may be violated by a coronal voiceless fricative adjacent to a stop. However, the details of those cases do not concern us here.

(104) Selection of the sympathy candidate:

P1		P2			
Base: .(gà.bri).(é.le). Input: /TRUNC -i/	PARSE SEG σ	ALIGN-TO- σ	1.MAX-IO 2.SSC	ALL σ L	MAX-BT
a. .gà.bri.é.le.<-i>	*	*!*		*****	
b. .gá.br-i.		*!*		*	iele
c. .gáb.r-i.		*!		*	iele
d. .gá.b-i.		*!		*	riele
e. .gá.-i.				*!	briele
f. .gáb.<r-i>	**	*!			iele
g. .gá.<br-i>	***	*!*			iele
h. .gá.<b-i>	**	*!			riele
i. .gábr.<-i>	*		*!(2)		iele
j. .gáb.			*!(1)		riele
k. .gáb.<-i>	*				riele
l. .gá.<-i.>	*				briele!

Candidates (a-e), which contain more than one syllable, may all be ruled out on the basis of the size minimizer, ALL σ L, although many of these candidates also violate [-i] alignment. Candidates (f-h) illustrate how the [-i] alignment constraint rules out candidates failing to place unparsed [-i] flush with a syllable edge in the sympathy candidate: any additional unparsed segmental material causes [-i] to be misaligned. These candidates lose even though (f) and (g) include more base material than the winner. The decision comes down to candidates (k) and (l), which both contain a single syllable and align [-i] to the syllable edge. The maximizing function of MAX-BT then selects (k) over (l).³²

³² A conceivable alternative with full syllabification of the sympathy candidate would posit the opaque interaction as arising between ALIGN-TO- σ and ONSET, giving a sympathy candidate of the form: [.gab.i.], with an onsetless final syllable. The P1 demand to satisfy ONSET in the actual output would force the appropriate syllabification in the optimal form. However, while ONSET is widely respected in German, it is not undominated, which raises complications for the analysis. Wiese (1996: 58-9) notes that glottal stop insertion takes place to fill the onset of a vowel-initial syllable in foot-initial position but not foot-medially (compare: Cháos 'chaos' versus cha[ʔ]ótisch 'chaotic'). This pattern is given by the ranking: ONSET_{FT}, MAX >> DEP >> ONSET. For ONSET to have an opaque interaction with ALIGN-TO- σ , this full

(104) shows that this ranking identifies the sympathetic candidate as (k) [.gáb.<i>], the most harmonic candidate with respect to the P2 hierarchy. The actual output is the candidate which matches the sympathetic form in segmentism, while satisfying PARSESEG σ . The transparent competitor, [.gáb.ri.], loses on a DEP- \emptyset O violation, as shown in (105). (The candidates [.gáb.] and [.gá.-i.] are not included in this tableau and will be discussed below.)

(105) Selection of the actual output:

	P1		P2				
	Base: (.gà.bri).(é.le.) Input: /TRUNC - i/	PARSE SEG σ	DEP- \emptyset O	ALIGN- TO- σ	1.MAX-IO 2.SSC	ALL σ L	MAX- BT
a. .gà.bri.é.le.<-i>	*!	riele	**		*****		
b. .gá.br-i.		r!	**		*		iele
c. .gáb.r-i.		r!	*		*		iele
d. .gá.b-i.			*		*		riele
e. .gáb.<r-i>	*!*	r	*				iele
f. .gá.<br-i>	*!***	r	**				iele
g. .gá.<b-i>	*!*		*				riele
h. .gábr.<-i>	*!	r			*(2)		iele
i. .gáb.<-i>	*!						riele
j. .gá.<-i.>	*!						briele

Although candidate (d) wins over (c) on DEP- \emptyset O, it fares worse on another sympathetic faith constraint: SROLE- \emptyset O, which requires that correspondent segments have identical syllable roles (McCarthy and Prince 1993a ch. 7; Gafos 1996). A violation of SROLE- \emptyset O is incurred for [b], which appears in a coda in the sympathy candidate but in an

hierarchy would have to belong to P1, giving rise to possible problems with free Faith violations in the sympathy candidate.

onset in the actual output (d). In the alternative candidate (c), [b] maintains its coda status. Since (c) loses to (d) in spite of its satisfaction of SROLE, DEP- O must outrank SROLE- O .

(106) DEP- O >> SROLE- O

	DEP- O	SROLE- O
a. (.gá.bi.)		*
b. (.gáb.ri.)	*!	

A second sympathetic faith ranking is evident when we compare [(gá.bi.)] with the alternatives [(gá.i.)] and [(gáb.)]. In contrast to the winning candidate, [(gá.i.)] and [(gáb.)] obey SROLE- O for [b] but violate MAX- O . This indicates that MAX- O also outranks SROLE- O . These rankings of sympathetic faith constraints will presumably also be required under Itô and Mester's account. I am simply working out the details of the rankings here.

(107) MAX- O >> SROLE- O

	MAX- O	SROLE- O
a. (.gá.bi.)		*
b. (.gá.i.)	*!	
c. (.gáb.)	*!	

The account is verified below for the cluster maximization example, [gorbat̪of] → [gorbi]. (108) illustrates selection of the sympathy candidate [(gorb.<i>)]. MAX-BT plays a maximizing role here, ensuring that the sympathy candidate has the largest possible coda cluster.

(108) Selection of the sympathy candidate:

P1		P2			
Base:(.gór.ba).(t̄ɸof.)	PARSE SEG σ	ALIGN-TO- σ	1.MAX-IO 2.SSC	ALL σ L	MAX- BT
a. .gór.ba.t̄ɸò.<f-i>	**	*!*****		***	
b. .gór.ba.<t̄ɸ-i>	**	*!***		*	of
c. .gór.b-i.		*!		*	at̄ɸof
d. .gór.r-i.		*!		*	bat̄ɸof
e. .gó.-i.				*!	rbat̄ɸof
f. .gór.<b-i>	**	*!			at̄ɸof
g. .górb.<-i>	*				at̄ɸof
h. .gór.<-i>	*				bat̄ɸof!
i. .gó.<r-i>	**	*!			bat̄ɸof
j. .gó.<-i>	*				rbat̄ɸo!f
k. .gór.ba.			*!(1)	*	t̄ɸof
l. .górb.			*!(1)		at̄ɸof

(109) exhibits the complete tableau, including sympathetic faith constraints.

(109) Selection of the actual output:

	P1			P2			
	PARSE SEG σ	1.MAX- ☉O 2.DEP- ☉O	SROLE -☉O	ALIGN- TO- σ	1.MAX -IO 2.SSC	ALL σ L	MAX- BT
B: (.gór.ba).(t̄j̄ðf.) I: /TRUNC -i/							
a. .gór.ba.t̄j̄ð.<f-i>	*!*	at̄j̄of(2)	*	*****		***	
b. .gór.ba.<t̄j̄-i>	*!*	at̄j̄(2)	*	***		*	of
c. .gór.b-i.			*	*		*	at̄j̄of
d. .gó.r-i.		b!(1)		*		*	bat̄j̄of
e. .gó.-i.		r!b(1)				*	rbat̄j̄of
f. .gór.<b-i>	*!*			*			at̄j̄of
g. .górb.<-i>	*!						at̄j̄of
h. .gór.<-i>	*!	b(1)					bat̄j̄of
i. .gó.<r-i>	*!*	b(1)		*			bat̄j̄of
j. .gó.<-i>	*!	rb(1)					rbat̄j̄of
k. .gór.ba.		i!(1)a(2)	*		*(1)	*	t̄j̄of
l. .górb.		i!(1)			*(1)		at̄j̄of

A summary of the rankings that have been established thus far for the harmonic sympathy analysis of German truncation is given in (110).

(110) Bifurcation triggered by opaque resolution of conflict between PARSESEG σ and ALIGN-TO- σ

- a. P1: PARSESEG σ
Sympathy. DEP-☉O, MAX-☉O >> SROLE-☉O
- b. P2: Size restriction. MAX-IO >> ALL σ L >> MAX-BT
Medial clusters. ALIGN-TO- σ , SSC >> MAX-BT

At this stage it is necessary to point out a problem that emerges under this account. The problem arises because the constraint, PARSESEG σ , which plays a broad function in determining well-formed outputs, is removed from P2. This means that PARSESEG σ cannot play any part in the selection of the sympathy candidate. MAX-IO may thus enforce selection of a sympathy candidate with unsyllabified material. Sympathetic faith would then cause these segments to be preserved in the optimal output, producing strings that do not actually occur in German.³³ An example is given in (111) with a possible input for [gabriele] containing extraneous unsyllabifiable segments. Since truncation is not directly relevant here, I have omitted truncation-related constraints from the tableau.

(111) Predicting unattested strings in actual output:

	P1		P2	
Input: bdgabriele	PARSE SEG σ	1. MAX- IO 2. DEP- IO	1. MAX-IO 2. DEP-IO	SSC
a. .ga.bri.e.le.		*!(1)	** (1)	
b. .bdga.bri.e.le.				*
c. <bd>.ga.bri.e.le.	*!* *			
d. .bəd.ga.bri.e.le.		*!(2)	* (2)	

The sympathy candidate in (111) is [<bd>.gab.ri.e.le.], which satisfies MAX-IO by preserving all input segments and circumvents syllable well-formedness by failing to parse the first two consonants. DEP-IO is shown in this tableau to illustrate that parsing the segments into a well-formed syllable by epenthesizing a vowel, as in (d), will still be less harmonic than the sympathy candidate in (c), because candidate (d) violates DEP-IO, while the constraint that (c) violates, PARSESEG σ , is not contained in P2. With candidate (c)

³³ Thanks to Armin Mester for raising this issue.

selected as the sympathy candidate, the actual output is (b), [.bdga.bri.e.le.], with the string of initial consonants syllabified into the first syllable. This output is selected because sympathetic faith forces the actual output to be identical in segmentism to the sympathetic candidate, and PARSESEG σ requires that all segments be parsed into some syllable. The outputs that correspond to well-formed outcomes for German, in (a) and (d), lose on the basis of sympathetic faith.

It should be noted that this kind of problem does not arise under constraint-based sympathy, because in that model all of the constraints contribute to selection of the sympathy candidate; derivational opacity is not achieved by setting a constraint aside in a separate component. One way of resolving the problem for the analysis of German in harmonic sympathy is to posit a different constraint in P1 for the opacity effect, one that is specific to truncation. A truncation-specific constraint is given in (112); this constraint is an M σ cat-to-M σ cat alignment constraint (McCarthy and Prince 1993b) demanding that the right edge of any TRUNC be aligned with left edge of [-i] in the output.

(112) TRUNC-TO-[-i]: ALIGN(TRUNC, R, [i]_{Af}, L)

If the alignment constraint in (112) were the constraint in P1 instead of PARSESEG σ , then full syllabification could always be enforced in the sympathy candidate. With PARSESEG σ respected in P2, it remains for us to ensure that the sympathy candidate for a truncatory form will consist of just one syllable with no additional unparsed material, matching the sympathy candidate selected under Itô and Mester's account. The alignment constraint in P1 will then require that [-i] occur following the truncatum in the actual output, producing a violation of DEP- σ O. The sympathetic faith constraints will prevent any additional material from being added. The ranking MAX-IO \gg ALL σ L \gg MAX-BT

restricts the size of TRUNC to one syllable. However, in addition to this, we must restrict the sympathy candidate to just TRUNC material (i.e. base-dependent material) excluding [-i]. This can be achieved with alignment constraints requiring that the left and right edges of the truncatum be aligned to the left and right edges of the word, respectively. These constraints are given in (113) and reflect that for the purposes of the sympathy candidate, the truncatory form behaves as if there were no suffix.

(113) TRUNC-TO-WD:

- a. ALIGN(TRUNC, R, WD, R)
- b. ALIGN(TRUNC, L, WD, L)

The tableaux in (114-115) illustrate the account using these constraints for the truncation of *Gabriele*. The tableau in (114) demonstrates how TRUNC-TO-WD selects a candidate containing only TRUNC material and the emergence of the unmarked ranking restricts TRUNC size to one syllable.³⁴ Only candidates respecting the sonority sequencing constraint are considered here.

³⁴ I assume that high-ranked constraints in P2 rule out candidates in which [-i] forms a word on its own or occurs outside of a word boundary.

(114) Selection of the sympathy candidate:

P1			P2			
B:(.gà.bri).(é.le.) I:/TRUNC - i/	TRUNC -TO[-i]	1.DEP- ⊗ O 2.MAX- ⊗ O	1.PARSE SEG σ 2.TRUNC- TO-WD	MAX- IO	ALL σ L	MAX- BT
a. .gà.bri.é.le.-i.		rielei(1)	*!(2)		***** *****	
b. .gá.br-i.		ri(1)	*!(2)		*	iele
c. .gá.b-i.		i(1)	*!(2)		*	riele
d. .gáb.	*			i		riele
e. .gá.	*	b(2)		i		briele!
f. .gá.-i.		i(1)b(2)	*!(2)		*	briele

In (115) we see the selection of the actual output. This is one that adds the [-i] suffix to the truncatum.

(115) Selection of the actual output:

P1			P2			
B:(.gà.bri).(é.le.) I:/TRUNC - i/	TRUNC -TO[-i]	1.DEP- ⊗ O 2.MAX- ⊗ O	1.PARSE SEG σ 2.TRUNC- TO-WD	MAX- IO	ALL σ L	MAX- BT
a. .gà.bri.é.le.-i.		ri!elei(1)	*!(2)		***** *****	
b. .gá.br-i.		ri!(1)	*!(2)		*	iele
c. .gá.b-i.		i(1)	*!(2)		*	riele
d. .gáb.	*!			i		riele
e. .gá.	*!	b(2)		i		briele
f. .gá.-i.		i(1)b!(2)	*!(2)		*	briele

This approach resolves the problem of predicting unattested strings in German by positing the P1 constraint as one specific to truncation. Because of this specificity, the placement of this constraint in P1 will not impact non-truncatory forms.

An alternative solution involves revising the opaque resolution of constraint conflict in harmonic sympathy. Recall that the problem for the analysis of German which placed PARSESEG σ in P1 was that this constraint no longer played any role whatsoever in selection of the sympathy candidate. This problem could be overcome if the opaque interaction of two constraints was resolved by the winning constraint being promoted to a P1 segment and also occurring dominated by the second constraint within P2, that is, hierarchy bifurcation would be induced so that a constraint which is dominated by another in selection of the sympathy candidate will still be respected in the actual output. Positing this occurrence of a constraint in both P1 and P2, enables the winning constraint (i.e. the one in P1) to still contribute (although dominated) to the P2 optimization. This allows a more general constraint to occur in P1, since it will also still perform a role within P2. In the case of the analysis outlined in (114-115), we could replace the truncation-specific P1 constraint with REALIZEMORPH, a constraint requiring that every morpheme in the input be phonologically expressed in the output (Samek-Lodovici 1992, 1993; Gnanadesikan 1996; Rose 1997). REALIZEMORPH would also occur dominated by TRUNC-TO-WD within P2. Because the morpheme realization constraint is otherwise high-ranked in P2, morpheme realization will be respected in the general case in sympathy candidates except when a violation is induced by truncatum-to-word alignment. The tableau in (116) illustrates how this revised model handles the German truncation.

(116) German truncation under revised model of harmonic sympathy:

P1			P2			
B:(.gà.bri).(é.le.) I:/TRUNC - i/	REALIZE MORPH	1.DEP- \otimes O 2.MAX- \otimes O	TRUNC- TO-WD	1.MAX-IO 2.REALIZE MORPH	ALLOGL	MAX- BT
a. .gà.bri.é.le.-i.		ri!elei(1)	*(2)		***** ****	
b. .gá.br-i.		ri!(1)	*(2)		*	iele
c. .gá.b-i.		i(1)	*(2)		*	riele
d. .gáb.	*!			** (1, 2)		riele
e. .gá.	*!	b(2)		** (1, 2)		briele
f. .gá.-i.		i(1)b!(2)	*(2)		*	briele

A benefit of this revised model is that it eliminates the truncation-specific alignment constraint in P1, although the analysis must still call on the truncation-specific TRUNC-TO-WD within P2. The goal of this account is simply to exhibit a possible way of analyzing the facts in the harmonic sympathy model, while preserving the insights of Itô and Mester's account where possible. The theoretical focus here is concerned not with the detailed particulars of analysis but rather with the overall opacity model in which the analysis is framed. In showing that it is possible to produce the opacity effect in German truncation under the harmonic sympathy model, the above account enables us to conclude that harmonic sympathy is not so restrictive that it fails to capture this kind of attested case. However, in the case of the German opacity effect, by calling on process-specific constraints to maintain the harmonic sympathy model, the analysis must attribute more complexity to Con (i.e. the set of universal constraints) than that required under constraint-based sympathy.

The revised model of harmonic sympathy, in which a constraint in P1 also occurs dominated within P2, is important not just to resolve the problem for the analysis of German but also to address the more general concern for the first model of harmonic

sympathy that if a constraint occurs only in P1, it no longer plays any role whatsoever in selection of the sympathy candidate. The revised approach also has a positive consequence in relation to the analysis of opacity in Tuyuca developed earlier in this chapter. Because the nasalized obstruent constraints would occur in both P1 and P2, the ranking structure in P2 would mirror the factorial ranking result from chapter 2, i.e. a language like Tuyuca, with transparent obstruents, would be one in which all nasalization constraints are dominated within P2. The transparent behavior of these segments in the actual output would arise as an opacity effect from the nasal obstruent markedness constraints occurring undominated in P1. The revised ranking structure is illustrated in (117). (Nasalized obstruent constraints are collapsed here as well as nasalized sonorant constraints.)

(117) Transparency in Tuyuca:

		P1		P2		
wāti		*NAS OBS	IDENT- NO [+nasal]	SPREAD ([+n], M)	*NAS OBS	*NAS SON
a.	[wā [̃] tī [̃]]	*!			*	***
b.	[wā [̃] ti]		**!	**		**
c.	w[ā [̃] ti]		**!* [̃]	***		*
d.	[wā [̃] t[ī [̃]]]		*	*****		***

In addition to preserving the factorial ranking result, this revised model would simplify the analysis of cross-morpheme spreading in Tuyuca. In particular, with the nasalized obstruent constraints appearing within P2, their domination of the word-spreading constraint can be achieved without calling on affix-specific nasal markedness constraints. Recall from section 3.3.4 that ranking the word-spreading constraint below *NASOBS within P2 produces the blocking behavior of obstruents in cross-morpheme

spreading. Earlier this P2 constraint was posited to be *NASOBS_{affix}, since the more general constraint was already located in P1; however, with a revised model in which *NASOBS occurs dominated by the morpheme-spreading constraint in P2, a positional markedness constraint is not required. In section 3.3.4 it was noted that it was odd for the general *NASOBS constraint to dominate *NASOBS_{affix} in the positional markedness context, but making use of *NASOBS in both P1 and P2 obviates this issue. The tableau in (118) shows how the occurrence of *NASOBS in both segments of the hierarchy yields transparent obstruents within morphemes and blocking obstruents in cross-morpheme spreading.

(118) Morpheme-internal transparency and cross-morpheme blocking by obstruents:

P1			P2			
āta-ta	*NAS OBS	IDENT- ⊗ O [+nasal]	SPREAD ([+n], M)	*NAS OBS	SPREAD ([+n], W)	*NAS SON
a. [ā̃tā]-ta	*!			*	**	**
b. [ā]ta-ta		*!*	**		****	*
c. [ā̃tā-tā]	*!*			**		***
d. [ā]t[ā]-ta		*	****		*****	**
e. [ā]t[ā]-t[ā]		*	*****!		***** ****	***

This revised approach to harmonic sympathy with a constraint occurring in both P1 and P2 amounts to saying that derivational opacity comes about when a constraint is dominated by another for the purposes of selecting the sympathy candidate, but wins in the selection of the actual output. In this sense, it is similar to a kind of spell-out of how a sympathetic constraint in constraint-based sympathy contributes to the selection of the sympathy candidate. Itô and Mester (1997a: 126) define selection of the sympathy

candidate in constraint-based sympathy as the candidate best satisfying the constraint hierarchy of the language, except with the sympathy constraint top-ranked. Assigning a constraint sympathy status is thus equivalent to invoking a second optimization with one constraint reranked. Under the revised version of harmonic sympathy, the hierarchy for the optimization determining the sympathy candidate is the hierarchy represented by P2. The hierarchy for selection of the actual output is then P1 and P2 together, where a dominated constraint in P2 occurs again in P1 to be top-ranked in this optimization. This approach shares with constraint-based sympathy the idea that selection of the sympathy candidate involves an optimization corresponding to a different constraint ranking from that selecting the actual output. Constraint-based sympathy expresses this through assigning a constraint sympathetic status; the revised version of harmonic sympathy expresses the ranking for the sympathy optimization directly in the hierarchy by making the sympathy candidate the one that is optimal with respect to P2, a contiguous segment of Eval. As outlined earlier in this chapter, the bifurcation of the hierarchy and occurrence of a constraint in P1 (as well as in P2), can be understood in terms of an opaque resolution of constraint conflict, an alternative to simple ranking without bifurcation. In the opaque resolution of conflict between two constraints, one constraint wins in determining the actual output, by occurring in P1; the other constraint wins in selection of the sympathy candidate by dominating the other in P2. Harmonic sympathy thus seeks to explicate and develop the notion of reranking for a sympathy optimization, an idea central to sympathy theory.

Finally, I briefly return to the two kinds of unattested opacity effects discussed in section 3.4 which constraint-based sympathy was capable of generating. The earlier version of harmonic sympathy ruled out these effects; however, under the revised version of harmonic sympathy, these must be reexamined. The first case involved maintaining the implications of universal constraint hierarchies (e.g. given by universal harmonicity scales). The tableaux in (119-120), repeated from section 3.4 illustrate a problem that

arises from assigning sympathy status to a low-ranked constraint in the peak hierarchy. Here assignment of sympathy status to *P/i causes /i/ to come out as a margin but the less harmonic /n/ can still be syllabic.

(119) /i/ must be a margin

tadi	MAX-IO *P/t *P/d	Faith- \otimes O	DEP-IO	*P/n	*P/i \otimes	*P/e *P/a
.ta.di.		*!			*	*
\otimes \otimes .ta.dAj.			*			**

(120) /n/ can be syllabic:

tadn	Max-IO *P/t *P/d	Faith- \otimes O	Dep-IO	*P/n	*P/i \otimes	*P/e *P/a
\otimes \otimes .ta.dn.				*		*
.ta.dAn.		*!	*			**

Under the revised version of harmonic sympathy, this problem still does not come about. In order for *P/i to be respected in selection of the sympathy candidate, it must be obeyed in the output best-satisfying P2; however, if *P/i must be respected, then all higher-ranked peak constraints must also be obeyed in the sympathy candidate. Thus, because harmonic sympathy spells out the ranking for the sympathy optimization, it explains why universal hierarchies are respected in opacity effects.

For completeness, universal hierarchies should also be considered in relation to the occurrence of markedness constraints within P1. In the analysis of nasal harmony, it should be the case that if any nasal markedness constraint occurs in P1, all higher-ranked constraints in the nasalization family must occur in P1 as well. For example, if *NASFRIC were to appear in P1 (as resolution of a conflict with SPREAD[+nasal]), then

*NASOBSSTOP must also occur dominating *NASFRIC in P1. This can be explained if universal constraint hierarchies are interpreted as requiring that wherever a constraint is located in the hierarchy for a given grammar, it must be dominated by some occurrence of each of the constraints dominating it in a universal hierarchy. Thus, any occurrence of *NASFRIC in a constraint hierarchy must be dominated by some occurrence of *NASOBSSTOP. The appropriate implications will thus be maintained in the revised harmonic sympathy model.

The second unattested opacity effect considered in section 3.4 is one in which a segment-specific markedness constraint, *p, is assigned sympathy status. In a language with epenthesis into complex clusters, the sympathetic status of *p can render [p] invisible to epenthesis, but high-ranked MAX-IO can still force [p] to surface in outputs. The first version of harmonic sympathy was able to rule this out, because placing MAX-IO in P1 caused all syllables to revert to an unmarked CV shape (see discussion in section 3.4). However, if MAX-IO also occurs in P2 dominated only by *p, then the unattested outcome can be achieved:

(121) /tarp/: No epenthesis

P1			P2				
/tarp/	MAX-IO	DEP- IO	*p	MAX-IO	*k, *r	*COMPLEX	DEP-IO
a. tarlp		**!	*		*		*
b. tarp		*	*		*	*	
c. tar	*!			*	*		
d. ta	*!*			**			
e. tap	*!		*	*			

(122) /tark/: Epenthesis

P1			P2				
/tark/	MAX-IO	DEP-IO	*p	MAX-IO	*k. *r	*COMPLEX	DEP-IO
a. tarlk					**		*
b. tark					**	*!	
c. tak	*!			*	*		
d. ta	*!*			**			
e. tar	*!			*			

The above opacity effect remains an outstanding issue for constraint-based sympathy and the revised version of harmonic sympathy. In the harmonic sympathy model it may be observed that the undesirable effect comes about when a segmental markedness constraint dominates faith (MAX-IO) in P2 but the faith constraint wins out in selection of the actual output by appearing in P1. This gives a P2 hierarchy in which [p] is excluded from the segmental inventory, and a P1 + P2 hierarchy in which [p] is a member of inventory. It would seem to be the case that opacity effects in which the inventory P2 admits is a smaller subset of the inventory admitted by P1 should be ruled out. This observation points to a possible direction for understanding why this kind of opacity effect does not occur, but I will leave exploration of the connection between P2 and inventory structure for further research.

Chapter 4

A PHONETIC STUDY OF GUARANÍ

In this chapter I report on an acoustic study of intervocalic voiceless stops in oral versus nasal contexts in Guaraní. Guaraní is a language well-known for its nasal harmony, in which all voiced segments become nasalized and voiceless segments behave transparent. An acoustic comparison of oral and nasal word pairs in Guaraní provides information about what effect, if any, nasal harmony has on transparent voiceless stops. In the previous chapter I proposed an analysis of transparency as an opacity effect, producing surface orality of transparent segments in nasal harmony. The findings of the study of Guaraní confirm the need for this result by showing that voiceless stops do typically surface as oral obstruent stops in nasal spreading domains.

In addition to establishing the basic transparent character of voiceless stops in Guaraní, the study makes several findings concerning context-dependent differences in voice onset time, closure voicing, and closure duration in oral versus nasal environments. Although it is apparent that voiceless stops in nasal spans should be represented as phonologically oral, the study identifies some systematic phonetic effects of nasal contexts on voiceless stops. Another discovery is that the total period of voicelessness appears to be fixed independent of context. The period of voicelessness emerges as a feature that is preserved in its total duration but is shifted in relation to stop closure and release in nasal environments. This suggests that, at least in Guaraní, the total voiceless duration is a quality contributing to the definition of voiceless stops. These results thus have implications for the phonetic correspondents of phonological features. An additional interesting set of findings concern the different patterning of the velar stop /k/ in contrast to the anterior stops, /p/ and /t/. The velar stop fails to conform to some of the generalizations established for the other places of articulation. I hypothesize that this separate behavior of

/k/ is a consequence of a threshold effect in which the velar stop reaches either a sufficient or maximal limit in its voice onset time, preventing a rightward shift of the voiceless period with just these segments.

This chapter is organized as follows. In section 4.1, I give background on the pattern of nasal harmony in Guaraní. Section 4.2 outlines the set-up of the acoustic study, describing how the data was collected and the method of instrumental analysis. In section 4.3 I report on the results of the study, first highlighting the general patterns, then detailing differences in timing in oral versus nasal contexts, and finally addressing the fixed quality of the total voiceless period. Section 4.4 discusses the implications of these results and provides a schematic scenario of what changes take place in oral versus nasal contexts. Section 4.5 briefly outlines a two-burst phenomenon observed in a small set of tokens, which appears to be correlated to nasal contexts. 4.6 is an appendix presenting the word pairs used in the study.

4.1 Nasal harmony in Guaraní

Guaraní belongs to the Tupí family of South America. The Tupí family is geographically located at points along the Amazon River and tributaries, in Paraguay, regions of Bolivia and Brazil, Northern areas of Peru and Argentina, and the South of French Guiana. The Guaraní language is centered in Paraguay, where it is one of the country's two official languages (along with Spanish) and is spoken by approximately two million people. Guaraní is also spoken in bordering regions of Argentina and Brazil. A large number of Paraguayan Guaraní speakers (over 50%) also speak Spanish: use of Guaraní predominates in rural areas and in certain sociolinguistic contexts. There are several grammars and dictionaries of Guaraní (e.g. Guasch 1948, 1956; Osuna 1952; Gregores and Suárez 1967), but little instrumental phonetic study of the language has been documented.¹

¹ Another Tupí-Guaraní language, Guarayu, has had some acoustic investigation by Crowhurst (1998).

Nasal harmony in Guaraní has excited much discussion amongst phonologists and phoneticians alike (see Gregores and Suárez 1967: Leben 1973: Lunt 1973: Rivas 1974, 1975: Anderson 1976: Goldsmith 1976: Sportiche 1977: Vergnaud and Halle 1978: Hart 1981: van der Hulst & Smith 1982: Poser 1982: Bivin 1986: Piggott 1992: Cohn 1993a: Trigo 1993: Flemming 1993: Steriade 1993d: Ladefoged & Maddieson 1996: Beckman 1998; among others). Various aspects of the pattern of nasal harmony are of theoretical interest. These include the transparency of voiceless segments, the nasal allophones of voiced segments, the interaction with metrical structure, effects of spreading across morphemes, and the role of prenasalized segments. The present study focuses on the first point: the transparency of voiceless segments in nasal harmony. I will outline the other main points to establish the appropriate set-up for the phonetic investigation. The following description draws on Gregores and Suárez (1967) and Rivas (1974, 1975).

The surface consonant inventory for Guaraní is given in (1) (after Rivas 1975: 134). The representation [a/b] indicates two allophones of the same phoneme.

(1) Guaraní surface consonant inventory:

	<u>Labial</u>	<u>Dental</u>	<u>Alveolar</u>	<u>Velar</u>	<u>Labiovelar</u>	<u>Glottal</u>
<u>vcls. stops</u>	p	t		k	k ^w	ʔ
<u>vcd. stop/affs.</u>	^m b/m	ⁿ d/n	^{dj} j/ɲ	^ŋ g/ŋ	^ŋ g ^w /ŋ ^w	
<u>fricatives</u>	s	ʃ	x/h			
<u>sonorants</u>	v/ [̃] v	l/ [̃] l	r/ [̃] r	ɣ/ [̃] ɣ	ɣ ^w / [̃] ɣ ^w	

A few notes on these segments are in order. First, all the voiced segments have oral and nasal allophones, the oral allophones occurring in the onset to an oral vowel and the nasal allophones occurring before nasal vowels — consonants occur only in onsets, the basic

syllable structure is open, (C)V (Rivas 1975: 135).² Voiced stops are realized as prenasalized in oral syllables and as fully nasal stops in nasal syllables. The alveolar voiced obstruent has variable oral realizations, ranging among [d̥j], [d̥ʒ], [ʒ], [j], with the prestopped forms occurring in stressed syllables and fully continuant variants occurring elsewhere. In nasal syllables, this segment is a full nasal stop, which sounds like it is articulated in the prepalatal or palatal region. The segments transcribed as [v], [ʏ], and [ɣ^w] are grouped by Rivas with the sonorants, and they are described by Gregores and Suárez as frictionless spirants (1967: 81-2). In nasal syllables, these segments are produced as nasal approximants. The segment transcribed as [r] represents a voiced alveolar flap. Voiceless segments are reported to have voiceless oral allophones in all environments. The velar fricative is in free variation with the glottal [h] (Gregores and Suárez 1967: 81).

The Guaraní vowels are listed in (2) (Rivas 1975: 134). There are three vowel heights and three degrees of tongue advancement. Nasalization is phonemic in vowels in stressed syllables only; elsewhere the distinction is allophonic.

(2) Vowel inventory:

	<u>Front</u>	<u>Central</u>	<u>Back</u>
<u>high</u>	i ī	i ī	u ũ
<u>mid</u>	e ě		o õ
<u>low</u>		a ā	

² Rivas notes three exceptions to the open syllable generalization. All three cases involve a coda nasal preceding a voiceless stop. Rivas points out that each of these words are interjections and can thereby be exceptional with regard to canonical structure (1975: 135).

Nasal harmony in Guaraní produces cross-segmental spans of nasalization in words. Bidirectional nasal spreading in the word is initiated by a nasal vowel in a stressed syllable. Nasalization spreads to all voiced segments and is reported to skip voiceless consonants. Spreading is blocked by a stressed syllable containing an oral vowel. In blocking syllables, both the vowel and onset consonant remain oral. In general, all segments in a syllable in Guaraní agree in orality and nasality: in the case of prenasal segments, it is by their oral release that they qualify as oral. Nasal spreading triggered by a stressed nasal vowel is illustrated in (3) (nasal spans are underlined). Blocking by a stressed oral syllable is shown in examples (c) and (d). (Below G & S 1967 refers to Gregores and Suárez 1967.)

- (3) a. /ⁿdo + roi + ⁿdupá + i/ → [nōrōĩnūpáĩ] (Rivas 1975)
 not + I-you + beat + NEG
 'I don't beat you'
- b. /ro + ^mbo + porá/ → [rōmōpōrā̃] (Rivas 1975)
 I-you + CAUS + nice
 'I embellished you'
- c. /idjakàrakú/ → [ʔĩnākàrākú] (G & S 1967)
 'is hot-headed'
- d. /akàray^wé/ → [ʔākàrāy^wé] (G & S 1967)
 'hair (of the head)'

Nasal spreading is also triggered by the nasal closure of a prenasalized stop. In this case, as would be expected, spreading is always regressive.

- (4) a. /ro + ^mbo + heⁿdú/ → [rōmōhēⁿdú] (Rivas 1975)
 I-you + CAUS + hear
 'I made you hear'
- b. /ro + ^mbo + γ^watá/ → [rō^mboγ^watá] (Rivas 1975)
 I-you + CAUS + walk
 'I made you walk'

In words with prefixes, nasalization in the root spreads to the prefix (see examples above). The situation is somewhat more complicated with suffixes. In general, suffixes can be grouped into two classes, resembling those in Tuyuca discussed in chapter 3. One suffix class is characterized by undergoing spreading of nasalization from the root. Suffixes in the other class are characterized by having a fixed oral or nasal quality. Alternating suffixes are unstressed in all but two cases:³ fixed oral suffixes are always stressed and fixed nasal suffixes may be stressed or unstressed. Fixed suffixes do not usually affect the oral/nasal quality of the root. However, if the suffix contains an oral stressed vowel and there is a voiced stop between the stressed suffix vowel and a stressed nasal vowel in the root, then nasalization spreads only as far as the voiced (prenasalized) stop. This produces a root with a nasal span followed by an oral span induced by the oral suffix (Rivas 1975: 138). The pattern is illustrated below with the fixed oral suffix, [ré] 'past'. In (a), this suffix remains oral after a nasal stem. In (b), it produces orality on the final syllable of an otherwise nasal root:

(5)	a.	/ir̥ + ré/	→	[ĩr̥uré]	(Rivas 1975)
		friend + PAST		'ex-friend'	
	b.	/m̥b̥ ⁿ da + ré/	→	[m̥ ⁿ daré]	(Rivas 1975)
		marry + PAST		'widow(er)'	
	cf.	/m̥b̥ ⁿ da/	→	[ménā]	(G & S 1967) ⁴
				'husband'	

³ The two alternating stressed affixes are the derivational suffixes: [-ʔó/-ʔō] and [-sé/-sē] (Gregores and Suárez 1967: 103).

⁴ Rivas also identifies a different kind of suffix behavior exhibited by a 'special class' of suffixes (1975: 138). Suffixes belonging to this class contain an oral stressed vowel and begin with either a voiceless stop or a voiced sonorant of the group [v, ɣ, ɣ^w]. After a nasal root, the suffix-initial consonant is changed to a homorganic voiced prenasalized stop and the suffix vowel remains oral. For some suffixes in this group the change is obligatory and for others it is optional.

The purpose of this summary of the data is primarily to review the facts in order to avoid any complications in the nasalization patterns in forms used in the study. The complexities of Guaraní nasal harmony are also fascinating from an analytical perspective, but that is not the main focus of the present chapter. The central analytical feature of Guaraní that concerns us here is that voiceless consonants behave transparent to nasal spreading. Following the analysis proposed for this kind of transparency in Tuyuca in the previous chapter, Guaraní is a language with an opacity effect whereby the nasal spreading constraint has an opaque interaction with the constraints prohibiting voiceless obstruents. This is captured by the ranking in (6) (after the analysis of Tuyuca). For the moment I focus only on the implications of this ranking for voiceless obstruents and will return to the matter of voiced stops presently.

(6) Voiceless consonants are transparent to nasal harmony:

P1

*NASOBS >> IDENT-~~☞~~O[±voice] >> IDENT-~~☞~~O[+nasal]

P2

SPREAD([+nasal], M) >> NASLIQUID >> *NASGLIDE >> *NASVOWEL

Because the nasal spreading constraint outranks all P2 nasalization constraints, this ranking selects a sympathetic candidate in which nasalization spreads to all segments in a nasal morpheme. The P1 nasalization constraint then rules out any candidates containing nasalized obstruents, and IDENT-~~☞~~O[±voice] >> IDENT-~~☞~~O[+nasal] selects the candidate with nasalization of all voiced segments. This analysis yields an output with surface-oral voiceless consonants in nasal harmony spans. The acoustic study of Guaraní voiceless

stops in oral versus nasal contexts is aimed in part at verifying the oral output for 'transparent' segments.

Before proceeding to outlining the details of the set-up of the phonetic study, I will briefly review the analytical implications of some of the other aspects of Guaraní nasal harmony. First, Guaraní nasalization is sensitive to stress. This has led some analysts to posit nasalization as limited by metrical domains (see, e.g., Flemming 1993) or feature percolation through a metrical tree (Sportiche 1977; Vergnaud and Halle 1978). Beckman (1998) takes a somewhat different perspective, suggesting that faithfulness constraints may be sensitive to prosodically prominent positions. She proposes that one such constraint, IDENT- σ [nasal], which enforces nasal feature identity in stressed syllables, can derive the effect of foot-bounded nasal harmony in Guaraní. In combination with featural markedness constraints, she shows that faith to stressed positions is also capable of deriving the limitation of phonemic nasality to stressed vowels. Beckman (1998) lays out this analysis with clarity, and the reader is referred to that work for the details.

On the subject of syllable patterns with voiced stops, Beckman (1998) also develops an insightful analysis, drawing on the aperture-theoretic representations of segments proposed by Steriade (1993a, d, 1994). These structures distinguish the closure and release phase of a stop, enabling prenasalized stops to be represented as nasalized during the closure but not the release, as suggested by Steriade (1993a, d, 1994). Making use of a constraint requiring agreement for nasality between adjacent positions of identical degree of aperture (e.g. stop release and a following vowel) and a VOINAS constraint, demanding that the closure phase of a voiced stop be nasal, Beckman is able to explain the syllable nasalization patterns for voiced stops in Guaraní. For the details of this account, the reader is again referred to Beckman's work.⁵

⁵ It should be noted that the cross-linguistic behavior of prenasalized stops in nasal harmony still needs further study. Steriade's aperture-theoretic representations have brought new insight into this area. Importantly, since Steriade's representations posit a closure phase for prenasalized stops which is actually

The core analysis of nasal spreading to voiced stops in Guaraní will parallel that of the Tucanoan family. In Guaraní, voiced stops undergo nasal spreading when the following vowel is nasal or becomes nasal through nasal spreading. This is realized with the same kind of ranking as that required for morpheme-internal spreading in Tuyuca outlined in chapter 3 (and repeated in (6) in this chapter). Constraints banning nasalized voiced obstruent stops are located in the P1 segment along with ones against voiceless obstruent stops. IDENT- \otimes O[\pm voice] is not violated by a nasal realization for voiced stops, so IDENT- \otimes O[+nasal] maps voiced stops to fully nasal sonorant stops. Guaraní also resembles the Tucanoan family in having a set of suffixes fixed in their nasality specification. This can be handled under the kind of analysis outlined in chapter 3, with a faith constraint for the class of fixed affixes outranking the constraint driving nasal spreading in the word.

This concludes the overview of Guaraní nasal harmony and its analytical implications. With the pattern of Guaraní nasalization in mind, I turn in the next section to outlining the set-up of the acoustic study of transparent voiceless stops.

specified as [+nasal], they correctly predict that prenasalized stops will trigger regressive spreading in Guaraní. A similar pattern occurs in Tinrin, a Melanesian language, where regressive nasal spreading is triggered by prenasalized stops along with nasal stops and vowels (Osumi 1995). Yet in some languages it is less clear that prenasalized stops are actually specified for [+nasal] in any portion of the segment. In several of the Tucanoan languages, voiced stops are realized as prenasalized (under certain conditions) in oral morphemes, and they do not trigger nasal spreading. This suggests that prenasalization in the Tucanoan family can occur as a phonetic enhancement effect to favor voicing in stops (Iverson and Salmons 1996 also propose this for some Mixtecan languages). These differences suggest that segments which have been described phonetically as prenasalized stops in various languages may correspond to more than one phonological representation, some having a [+nasal] specification and others not (see Iverson and Salmons 1996 for a similar conclusion). Further pursuit of these issues is left for future research.

4.2 Set-up

4.2.1 Data and data collection

The goal of the present study is to compare the acoustic properties of intervocalic voiceless stops in oral versus nasal contexts.⁶ The data for this study consist of unsuffixed bisyllabic words of the form (C)VCV́, which follows the most common pattern of Guaraní stress in roots. In some words the initial consonant is a pronominal prefix included in the domain of nasal harmony. The medial consonant in all words was a voiceless stop, [p], [t], or [k], which formed the subject of investigation. Each bisyllabic word defines a nasal harmony domain, where the nasality of the stressed vowel determines the oral/nasal quality of the word. In nasal words, both vowels are nasal by regressive spreading from the final stressed nasal vowel, and in oral words, both vowels are oral. Six oral/nasal near minimal pairs were compared for each of the three places of articulation for voiceless stops: in the case of [t], there were seven word pairs. Word pairs matched minimally in the place of the medial stop, in the height of the vowels following the voiceless stop, and in the height of the vowels preceding the voiceless stop. Some examples are given in (7). A complete list of the word pairs used in the study is given in the appendix of this chapter (section 4.6).

⁶ The present study focuses on voiceless stops only. Voiceless fricatives in Guaraní are also reported to be transparent to nasal harmony, but because of their continuancy, the investigation of these segments requires rather different points of comparison. See Gerfen (1996) for a recent nasal airflow study of transparent and blocking voiceless fricatives in the nasal harmony of Coatzospan Mixtec. Gerfen's study finds that nasal airflow is maintained during a 'transparent' voiceless fricative (but see Ohala, Solé, and Ying 1998 for discussion of the weakening effects of nasal airflow on voiceless fricatives). In an acoustic study, fricative nasalization could perhaps be judged by comparing amplitude of the fricative energy — this might be stronger or focused at different frequencies if there were nasal airflow — however, a more direct technique, such as direct examination of the velum position, would give firmer results.

(7) Examples of Guaraní bisyllabic word pairs:

	Nasal		Oral	
	(C)ṼCṼ́		(C)VCṼ́	
a.	[põpĩ́]	‘to peel, strip’	[dʒopĩ́]	‘to itch’
b.	[tãtĩ́]	‘horn’	[tatĩ́]	‘daughter-in-law’
c.	[õké]	‘door’	[oké]	‘to sleep’

The language consultant for the study was a Paraguayan male, 32 years of age, who has spoken Guaraní since before the age of 10. The consultant’s proficiency in the language includes both native fluency and native accent ability. The context of use for this speaker is as a spoken language, rarely as a written one. The language was spoken by the consultant most frequently in the countryside or marketplace, corresponding to a common sociolinguistic situation of language use in Paraguay. Other languages spoken by the consultant are Spanish, Portuguese, and English. At the time the recordings were made, the consultant had spent three school years outside of Paraguay (in England and the United States), but he returned to Paraguay for four months of each of those years, during which he would speak Guaraní and Spanish. The written word list was carefully reviewed with the consultant in advance of the recording to ensure familiarity with all of the words. With this advance exposure, the written format of the list did not pose a problem, since many of the orthographic conventions of Guaraní follow Spanish ones.

The recordings were made with the speaker reading into a microphone in a sound-insulated room in the phonetics laboratory at the University of Massachusetts at Amherst.⁷

⁷ I am grateful to John Kingston for permission to use the Phonetic Lab at the University of Massachusetts and for help with setting up the study as well as providing comments on analysis of the data. I would also like to express thanks to Jaye Padgett and John Ohala for discussion of aspects of the data analysis and to John McCarthy for sponsoring my visit to the University of Massachusetts. Any errors are

Words were read in an oral word frame: [ere 'X' djei] 'say 'X' again'. In this sentence, the main stress fell on the final vowel of the bisyllabic CVCV word. Nasal harmony did not extend across word boundaries, leaving the medial word unaffected by the frame words. Words were read at a normal speech rate grouped in random batches of 12 different words. Of each batch of 12 items, the first and last token were discarded, as intonation and emphasis was sometimes affected at these boundaries. Breaks in recording were taken as needed. A total of six valid repetitions of each word were recorded.

4.2.2 Instrumental analysis

The recordings were digitized using a sampling rate of 20,000 Hz. Durations of various of the segmental components were measured on a Kay Elemetrics Computerized Speech Lab Model 4300 at the University of California, Santa Cruz, making reference to both waveforms and spectrograms. On each digitized token, four points were tagged. The criteria by which these points were identified are described below, and they are illustrated on the waveform and spectrogram in (8) showing the VCV segment of the oral word [pokó] 'to touch'. The first point (a) marks the initiation of closure for the medial voiceless stop. This is signalled by the beginning of a gap in the spectrogram at the end of vowel formant structure for the first vowel. The second point (b) marks the end of voicing into the stop, signalled by the end of periodic oscillations after the first vowel in the waveform. The third point (c) marks the release of stop closure. This is signalled by the occurrence of a burst spike on the spectrogram and the initiation of aperiodic 'noise' on the waveform. Finally, (d) marks the onset of voicing in the following vowel, indicated on the waveform by the resumption of periodic oscillations after the aperiodic burst energy. On the spectrogram this corresponds to the beginning of a voicing bar and/or vertical striations.

entirely my own and are not a reflection on any of these individuals. Thanks to Manuel Ferreira for consultation on the Guaraní language.

(8) Sample waveform and spectrogram for VCV portion of [po'ko] 'to touch'.

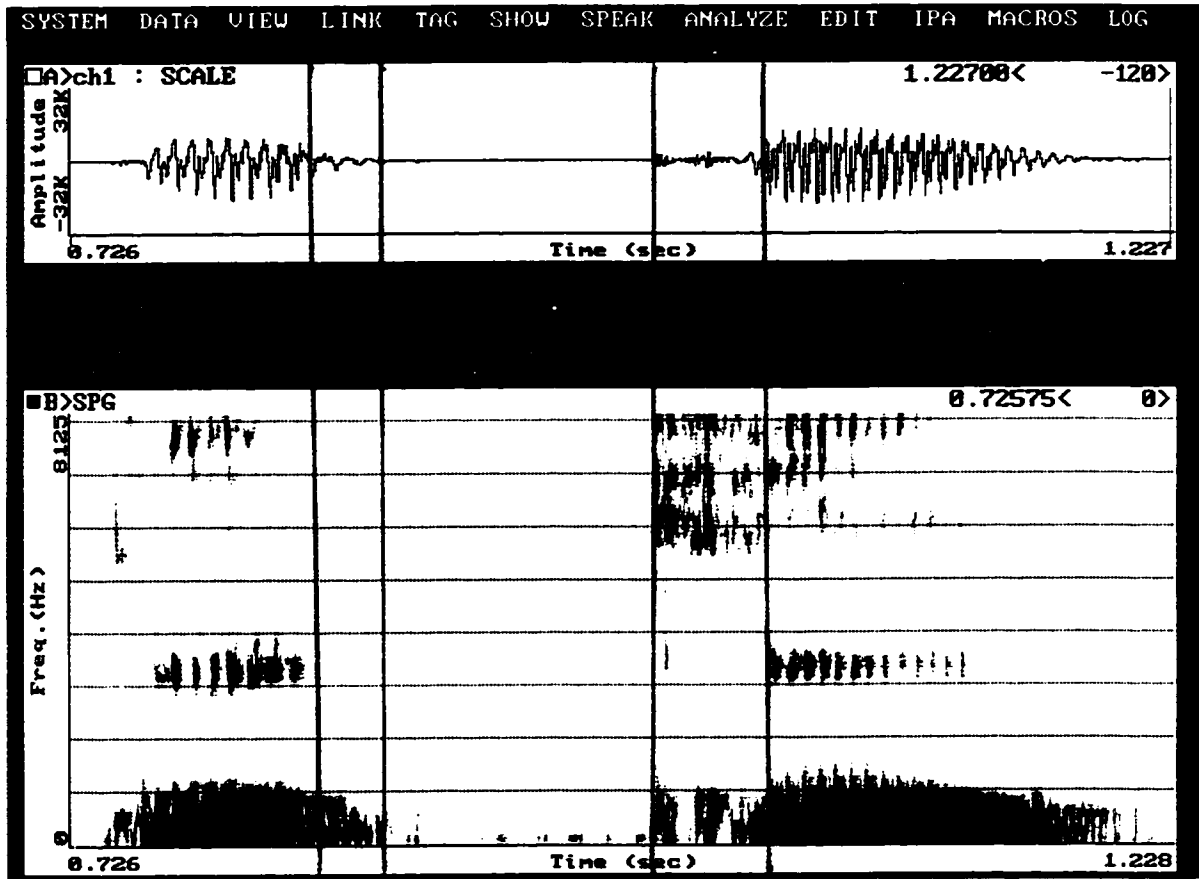

(a) (b) (c) (d)

- a. Initiation of closure for medial voiceless stop.
- b. End of voicing into medial stop.
- c. Release of stop closure.
- d. Onset of voicing in following vowel.

Because of the root-final stress in the bisyllabic words, the amplitude of the second vowel was much greater than the first, often resulting in a very weak spectrographic image for the first vowel. In many tokens this made it difficult to identify the initiation of closure in an unmodified spectrogram, because formant structure for the first root vowel was very faint. In order to enhance visibility of the formants in the unstressed vowel, two steps were taken. First, the amplitude of the speech signal was increased by a factor of two from the original to improve the darkness of the displayed image. The spectrograms shown in this chapter have undergone this double gain. If the increased amplitude was still not sufficient to reveal the boundaries of the first vowel, pre-emphasis was applied to flatten the spectral shape of the voiced speech signal and bring out the spectral characteristics of the higher frequencies with similar resolution to those of the lower frequencies. This made visible the areas of the signal where formant energy occurred. Since the resulting spectrogram distorted other properties of the signal, such as voicing, the other points were marked before pre-emphasis was performed (pre-emphasis is not performed in the spectrogram in (8)).

From the four marked points on each token, various durations were measured. The following report focuses on five of these durations: (i) Closure Voicing, which measures from initiation of stop closure (8a) to the end of voicing after the first vowel (8b); (ii) Closure Duration, measuring from initiation of closure (8a) to the release of closure (8c); (iii) Voiceless Closure Duration, from the point of end of voicing into the stop (8b) to the release of closure (8c); (iv) Voice Onset Time, measuring from the release of stop closure (8c) to the onset of voicing (8d); and (v) Total Voiceless Period, the duration from the end of voicing into the stop (8b) to the onset of voicing in the following vowel (8d). Each of these durations were measured for all six tokens of each oral word and then averaged and compared with the average for the nasal pair word. Comparisons were made by oral

versus nasal words across and within places of articulation for the medial stop. Computations and statistical analysis were performed using Excel 5.0 software. The analyses of variance in oral versus nasal words were tested using a two-factor Anova. The results are reported on and interpreted in the following section.

4.3 Results

The results of the study are presented at three levels of detail. First I summarize the general patterns of closure and voice timing common to oral and nasal words. Then I discuss different properties of timing in oral versus nasal words taken as a whole across the sample, followed in each case by an examination of the effect of place of articulation on any timing differences. It will emerge that there are interesting differences in the timing properties of voiceless stops in oral versus nasal words, but words with velar stops are often the exception to the generalizations. This, I propose, is explained by a threshold effect for /k/, which I suggest achieves a sufficient or maximal voice onset time.

4.3.1 General patterns

I begin by remarking on the general patterning of voiceless stops in both oral and nasal words. One focal observation is that /p, t, k/ are typically realized as oral obstruent stops in both oral and nasal spans. In nasal spans it is not the case that they become fully voiced or fully nasal during the closure, nor are they produced as voiceless nasal stops. The absence of voicing for a substantial period during the stop is clearly discernible from both the spectrogram and waveform. The orality is evident from the gap during the closure, indicating the absence of the energy that would be produced by nasal airflow. The stops are also accompanied by a robust burst, showing that pressure has accumulated behind the

closure in the oral cavity, and so air has not escaped freely through the nasal passage. A sample spectrogram and waveform for the nasal word [õkẽ] 'door' is shown in (9).

(9) Sample waveform and spectrogram for [ō'kē] 'door'.

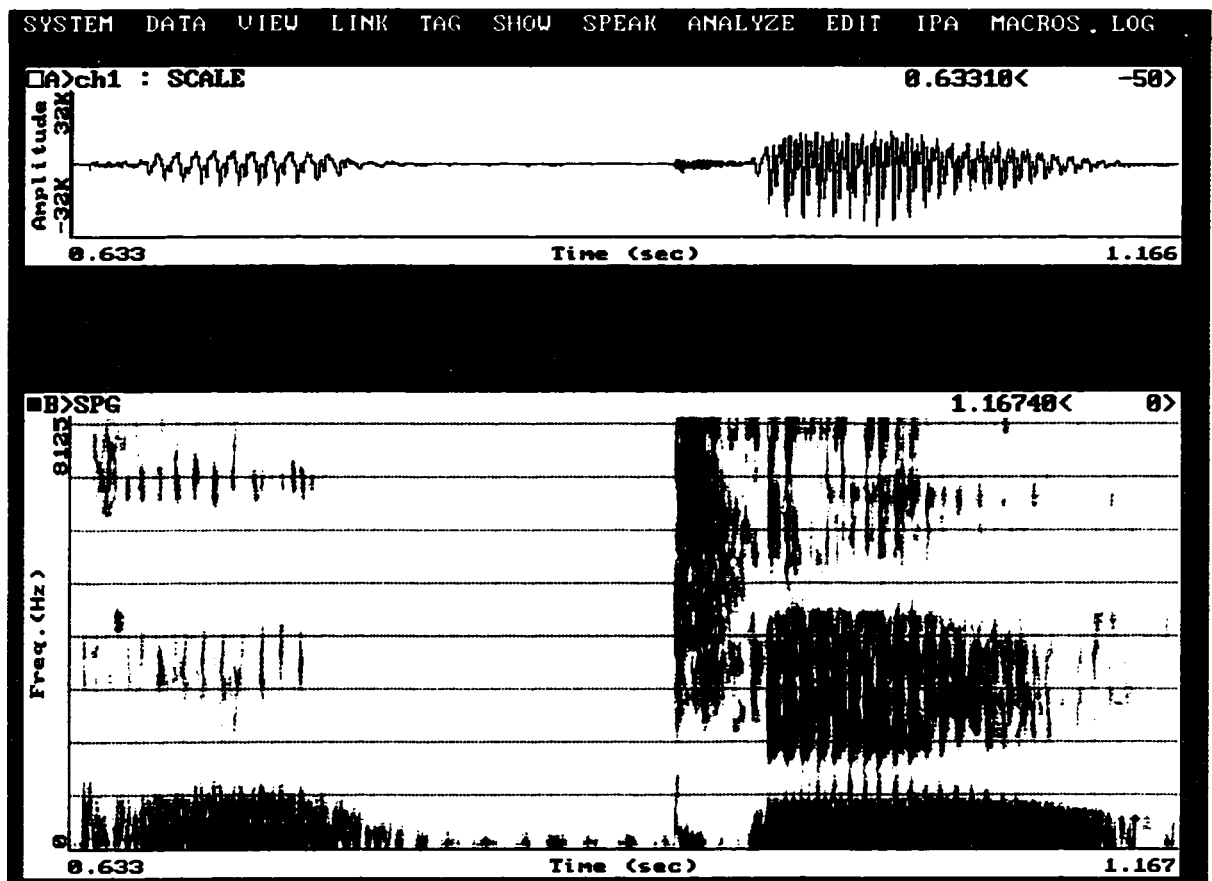

This acoustic information confirms the transparency effect that has been reported in the Guaraní grammars. The surface orality of the ‘transparent’ voiceless stops is consistent with the analysis of transparency as an opacity effect: the output representation posited for these segments is an oral one, they are truly non-nasal at the surface. These transparent segments cannot be analyzed as instances of ‘false transparency’ where the velum remains lowered throughout the full duration of the segment.⁸

Another point on the subject of common acoustic patterns concerns voice timing. In both oral and nasal environments, voicing persists part-way into the stop closure. The closure voicing is followed by a period of voicelessness, which begins during the closure and persists for a period after the release. Although this basic model characterizes voiceless stops in both contexts, some of the details of the timing differ by environment. These differences are discussed below. First I outline the effects that were discovered to be conditioned by nasal environments, and then by comparing aspects that remain fixed. I posit a defining acoustic property of voiceless stops.

4.3.2 Effect 1: Ratio of closure duration to voice onset time

One of the major context-induced effects found in this study is that the average ratio of closure duration to voice onset time (CD/VOT), i.e. the average of the CD/VOT ratios, is overall significantly smaller in nasal contexts than in oral ones. The reason that the CD/VOT ratio was calculated rather than only evaluating closure and voice onset time separately was to control for any word-to-word or token-to-token variation in speaking rate. The individual contributions of the differences in closure length and voice onset time

⁸ A cursory examination of some audio recordings of Desano (Tucanoan; Colombia) showed the same basic surface transparent character for voiceless stops in nasal morphemes (recordings were made by Jonathan Kaye 1965-1966). I am grateful to Jonathan Kaye for making his recordings of Desano available to me.

will be examined presently. The difference in the ratios of closure duration over voice onset time are given in (10), taken across all three places of articulation. The average for oral contexts of 7.375 is greater than the nasal average of 5.597, a difference which is statistically significant ($p < 0.0001$).

(10) Closure duration/Voice onset time (CD/VOT): results across sample

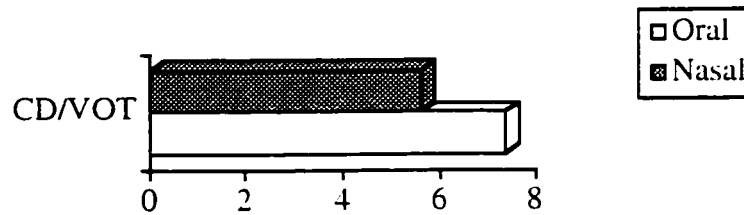

	Oral	>	Nasal	
Number of tokens	108		108	
Variance	9.990		6.109	
Average CD/VOT	7.375	>	5.597	$df = 1, F = 34.02, p < 0.0001$

The cause for the difference in the ratio of closure to voice onset time can be traced to both of the logically possible contributors: in nasal contexts voice onset times are longer and closure durations are shorter. The average voice onset times are given in (11): 26.64 msec. in oral words and 32.80 msec. in nasal words ($p < 0.0001$). The greater values in nasal words give a greater denominator in CD/VOT, yielding smaller ratios for nasal environments.

(11) Greater VOT in nasal contexts.

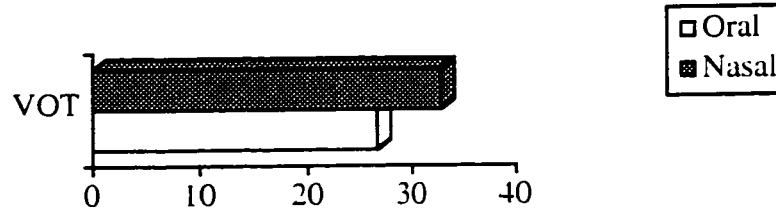

	Oral	<	Nasal	
Number of tokens	108		108	
Variance	0.13		0.14	
Avg. VOT (msec.)	26.64	<	32.80	$df=1, F=26.88, p < 0.0001$

Average closure durations for the intervocalic voiceless stops are shown in (12). The average closure is longer in oral environments (165.37 msec.) than in nasal ones (158.20 msec.; $p < 0.005$). The shorter closures in nasal words give a greater numerator in the CD/VOT ratio, contributing to the smaller nasal CD/VOT values.

(12) Shorter closure durations in nasal contexts.

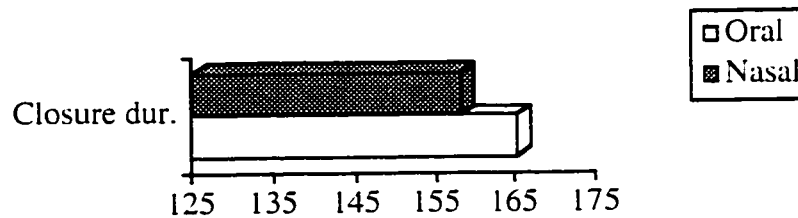

	Oral	>	Nasal	
Number of tokens	108		108	
Variance	0.38		0.30	
Avg. closure dur. (msec)	165.37	>	158.20	$df=1, F=8.30, p < 0.005$

So far we have considered results across the entire sample of data, but when the tokens are sorted by place of articulation of the medial stops, we find that place interacts

with the difference in CD/VOT in nasal versus oral words. The results for closure duration over voice onset time for each place of articulation are displayed in (13). For both [p] and [t], the ratio is significantly greater in oral contexts than in nasal ones. For [p] the difference is greatest, with an average value in oral words of 8.880 comparing with an average of 5.859 in nasal words ($p < 0.0001$). The figures for [t] are roughly similar: oral average 8.670 versus nasal average 6.838 ($p < 0.0001$).⁹ The velar, [k], is the odd one out, having no significant difference in CD/VOT in oral versus nasal environments (oral average 4.241 and nasal average 4.101; $p = 0.5$).

(13) Closure duration/Voice onset time by place of articulation.

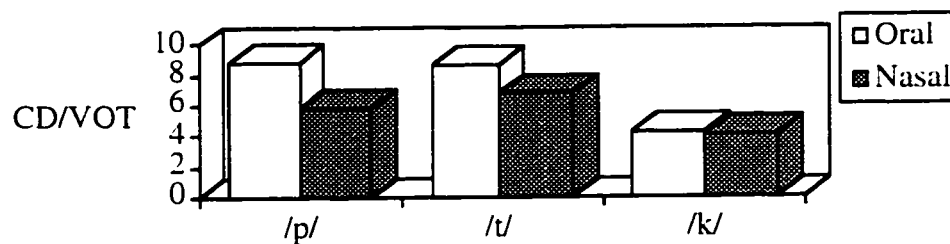

	/p/ significant		/t/ significant		/k/ not significant	
	Oral	Nasal	Oral	Nasal	Oral	Nasal
No. of tokens	36	36	42	42	36	36
Variance	7.171	6.950	7.051	6.076	0.866	1.368
Avg. CD/VOT	8.880	5.859	8.670	6.838	4.241	4.101
	$df = 1, F = 40.73, p < 0.0001$		$df = 1, F = 25.93, p < 0.0001$		$df = 1, F = 0.45, p = 0.5$	

⁹ In computations by place of articulation, data from all seven words pairs for [t] are included, giving a total of 84 tokens (42 for each of oral and nasal with six repetitions of each of the seven words). The six word pairs for [p] and [k] yield 72 tokens for each of these places. In oral/nasal comparisons combining data from all three places of articulation, durations for only six word pairs for [t] were included in order to balance with the number of tokens for [p] and [k], giving a total of 216 tokens (3 x 72). The word pair for [t] excluded in comparisons across all places of articulation is [paṭi]/[kaṭi] chosen at random.

In addition to not having a different CD/VOT value in oral versus nasal contexts, [k] is remarkable in two other respects. One feature clearly visible on the bar graph in (13) is that the value of CD/VOT for [k] is much smaller than for [p] or [t]. The other point is that the variance for [k] is much smaller than for the other stops. Variance for the velar is in the neighborhood of about 1, but for [p] and [t] the variance is as high as 6 to 7. This suggests that aspects of the timing with velars are highly fixed in comparison to the other stops. I will return to these points after looking at a few more of the results sorted by place of articulation.

(14) gives voice onset times by place of articulation. Once again [p] and [t] conform to the general pattern, exhibiting significantly greater voice onset times in nasal contexts (oral average 20.59 msec. for [p] and 20.38 msec. for [t] versus nasal average 31.47 msec. for [p] and 26.65 msec. for [t]; $p < 0.0001$). [k], on the other hand, does not have significantly different voice onset times in oral versus nasal words: its voice onset time is consistently about 40 msec.. Notice that voice onset times for [k] far exceed those of the anterior stops. The occurrence of longer voice onset times for velars than for anterior stops accords with the findings of other studies on place and voice onset time: Lisker and Abramson (1964) were the first to report this observation. In the Guaraní data, this difference by place is such that even in oral environments, voice onset times for [k] are about 10 msec. longer than for nasal bursts in other places of articulation. It may be noted that the variances here are at least twice as great in nasal than in oral words. This difference will be discussed in section 4.4.

(14) Voice onset time by place of articulation.

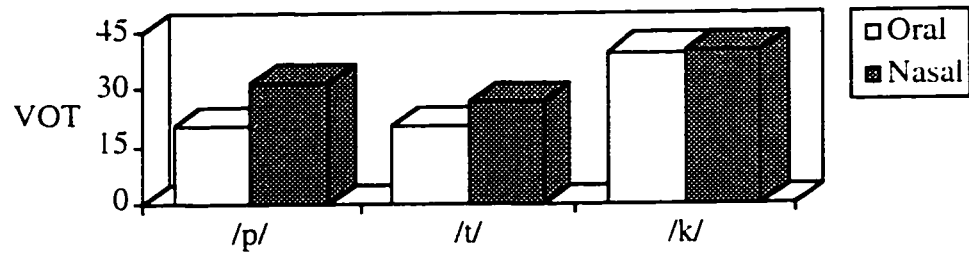

	/p/ significant		/t/ significant		/k/ not significant	
	Oral	Nasal	Oral	Nasal	Oral	Nasal
No. of tokens	36	36	42	42	36	36
Variance	0.036	0.14	0.029	0.076	0.059	0.12
Avg. VOT (msec.)	20.59	31.47	20.38	26.65	39.80	40.11
	<i>df</i> = 1	<i>F</i> = 38.29	<i>df</i> = 1	<i>F</i> = 27.44	<i>df</i> = 1	<i>F</i> = 0.03
	<i>p</i> < 0.0001		<i>p</i> < 0.0001		<i>p</i> = 0.87	

The values for closure duration by place of articulation are shown in (15). Here [p] and [k] are significantly different with shorter closures in nasal contexts (oral average for [p] 168.86 msec. and for [k] 163.17 msec. versus nasal average for [p] 158.64 msec. and for [k] 153.47 msec. $p < 0.005$). Interestingly, closure duration for [t] is not significantly shorter in nasal words. In section 4.5 we will see that this is connected to some tokens for nasal words with [t] having two burst events, which produced increased closure durations. An alternative way in which a distinction is achieved for the closure properties of [t] in nasal contexts is discussed in the next section on closure voicing.

(15) Closure duration by place of articulation.

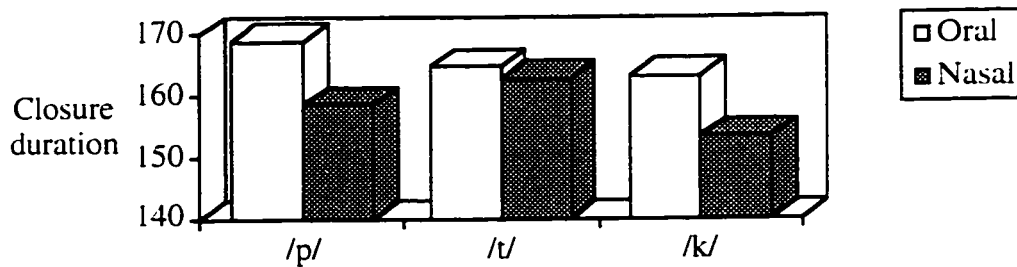

	/p/ significant		/t/ not significant		/k/ significant	
	Oral	> Nasal	Oral	Nasal	Oral	> Nasal
No. of tokens	36	36	42	42	36	36
Variance	0.29	0.25	0.27	0.37	0.56	0.22
Avg. closure duration (msec.)	168.86	158.64	164.67	162.83	163.17	153.47
	<i>df</i> = 1	<i>F</i> = 8.69	<i>df</i> = 1	<i>F</i> = 0.38	<i>df</i> = 1	<i>F</i> = 8.69
	<i>p</i> < 0.005		<i>p</i> = 0.54		<i>p</i> < 0.005	

To summarize, the findings reported so far are that the ratio of closure duration to voice onset time is greater in oral contexts than in nasal ones. A strong contributing factor is longer voice onset times in nasal words ($p < 0.0001$) and a somewhat weaker factor is shorter closure durations in nasal words ($p < 0.005$). The velar stop proves to be somewhat exceptional in not having a significantly different CD/VOT average in nasal words or a significantly different average voice onset time.

The general pattern that has been identified is that in nasal intervocalic environments, voiceless stops have longer voice onset times and shorter closures. It is interesting that there is an inverse relationship in the timing of the two segments: longer closures cooccur with shorter voice onsets. We will see ahead that this is a consequence of the voiceless period of the stop undergoing a shift to the right in nasal environments. However, velar stops are the exception. This, I suggest, is related to the fact that velars

make the most successful voiceless obstruent stops. In comparison to the anterior stops, the back site of constriction for a velar produces a smaller cavity behind the closure, favoring the build-up of pressure needed to inhibit voicing. The effect of this was apparent in (14), where [k] had greater voice onset times than either [p] or [t] (correlating with differences by place for voice onset times in other languages: Lisker and Abramson 1964). Recall also that [k] exhibited comparatively minimal variance in the CD/VOT ratio, indicating that aspects of the timing in the production of [k] are considerably more fixed than in [p] or [t]. I hypothesize that the separate behavior of [k] in nasal contexts is the consequence of a threshold effect for the length of its VOT. The voiceless period in anterior stops shifts to the right in nasal environments. In the case of [k], a shift does not take place to produce a longer voice onset time, because it has achieved a threshold in its duration. This threshold could be understood in one of two ways, which are open to empirical verification in further work. It could either be that [k] already has a *maximal* voice onset time, preventing any further carry-over into the following vowel or [k] has a *sufficient* voice onset time, one that does not need to be enhanced when the voiceless portion of the closure is shortened. These points will be synthesized after examination of the second major timing effect in oral versus nasal contexts.

4.3.3 Effect 2: Ratio of closure duration to closure voicing duration

The second main effect discovered in the production of voiceless stops in oral versus nasal words is that the average ratio of closure duration to closure voicing duration (CD/CV), i.e. the average of the CD/CV ratios, is overall significantly smaller in nasal words. This means that a greater portion of the closure is voiced in a nasal vocalic environment. The averages are given in (16). The oral ratio of 8.29 exceeds the nasal one of 6.66 ($p < 0.02$).

(16) Closure duration/Closure voicing duration (CD/CV): results across sample.

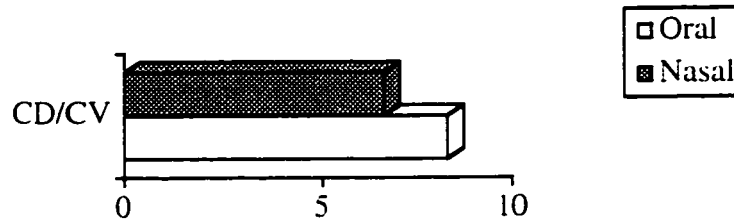

	Oral	>	Nasal	
Number of tokens	108		108	
Variance	34.10		15.27	
Average CD/CV	8.29	>	6.66	$df = 1, F = 5.89, p < 0.02$

When examined by place of articulation, it emerges that the difference in the closure duration to closure voicing ratios holds specifically of tokens with [t]. The averages are shown in (17), with an average value for oral tokens of 7.83 and for nasal tokens of 5.09. The difference in the cases of words with [p] and [k] is not statistically significant.¹⁰

¹⁰ Only six of the seven word pairs for [t] are reported here. The seventh word pair ([mbotí], [motí]) was aberrant in displaying an unusually high variance (363.07 for oral tokens, 143.63 in nasal tokens). With this word pair included, the difference for CD/CV in oral versus nasal words was still significant: number of tokens for each of oral and nasal = 42; average 8.85 oral, 5.98 nasal; variance 61.84 oral, 24.73 nasal; $df = 1, F = 4.25, p = 0.04$. In general, the oral tokens exhibit a higher variance for the CD/CV ratio than nasal tokens, although the cause for this is unclear.

(17) Closure duration/Closure voicing duration (CD/CV) by place of articulation.

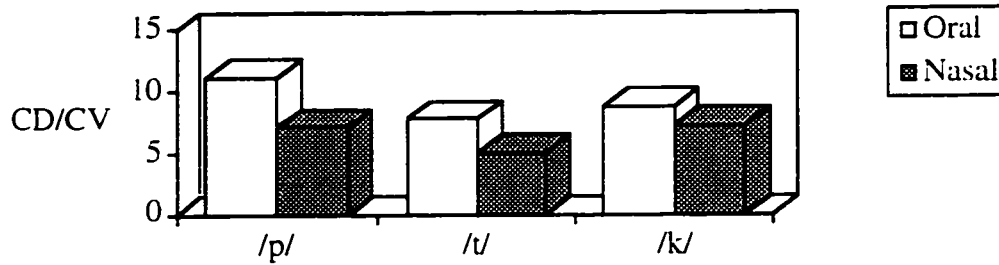

	/p/ not significant		/t/ significant		/k/ not significant	
	Oral	Nasal	Oral	Nasal	Oral >	Nasal
No. of tokens	36	36	36	36	36	36
Variance	7.00	6.69	13.20	1.90	19.50	10.27
Avg. CD/CV	11.21	7.11	7.83	5.09	8.83	7.28
	<i>df</i> = 1	<i>F</i> = 0.34	<i>df</i> = 1	<i>F</i> = 29.06	<i>df</i> = 1	<i>F</i> = 3.73
	<i>p</i> = 0.56		<i>p</i> < 0.0001		<i>p</i> = 0.058	

Although closure durations were found to be shorter in nasal words for [p] and [k] (see (15)), giving a smaller numerator for CD/CV, this was not sufficient to produce a significant difference in the CD/CV ratio. Recall, however, that [t] did not have a significantly different average closure duration in oral versus nasal contexts. For [t], there was found to be more closure voicing in nasal environments yielding an increase in the voiced portion of the closure. This is shown in (18). Between oral vowels the average closure voicing for [t] is 24.78 msec. and in nasal words this increases to 34.07 msec. ($p < 0.005$). [p] and [k] do not have a significant difference in closure voicing in nasal versus oral contexts, which accords with their lack of difference in CD/CV.

(18) Greater closure voicing for /t/ in nasal contexts.

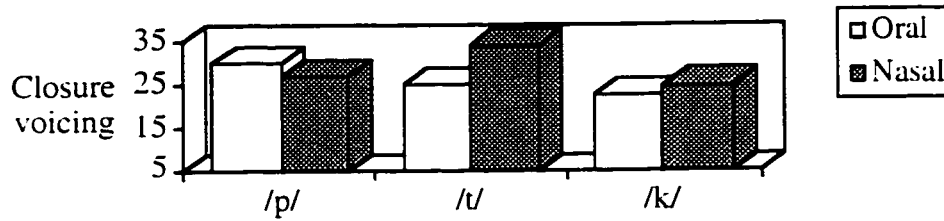

	/p/ not significant		/t/ significant		/k/ not significant	
	Oral	Nasal	Oral	< Nasal	Oral	Nasal
No. of tokens	36	36	42	42	36	36
Variance	0.24	0.092	0.12	0.35	0.097	0.090
Avg. closure voicing (msec.)	29.98	26.95	24.78	< 34.07	22.42	24.54
	<i>df</i> = 1 <i>p</i> = 0.1	<i>F</i> = 2.66	<i>df</i> = 1 <i>p</i> < 0.005	<i>F</i> = 8.92	<i>df</i> = 1 <i>p</i> = 0.2	<i>F</i> = 1.69

A related property that holds consistently across all places of articulation is a shorter duration of the voiceless period of the closure in nasal contexts. This is illustrated in (19). Between oral vowels, the voiceless closure is around 140 msec. in duration, while in nasal contexts this falls to about 130 msec..¹¹

¹¹ It should be noted that on some points of comparison, including duration of voiceless closure, the analysis of variance indicated that within the set of words for a given place of articulation, an interaction was registered with individual word pairs. This means that particular word pairs sometimes showed a stronger or weaker effect for the oral/nasal contrast in question. It is possible that the height of the flanking vowels was an influencing factor here, although since the study was not designed to test this, we do not have enough information from the data to tell for certain. Examination of the results by word did not reveal any obviously systematic effect of vowel height, but this could be investigated more fully with a set of word pairs specifically constructed to compare the effect of adjacent vowel quality.

(19) Voiceless closure shorter in nasal contexts for all places of articulation.

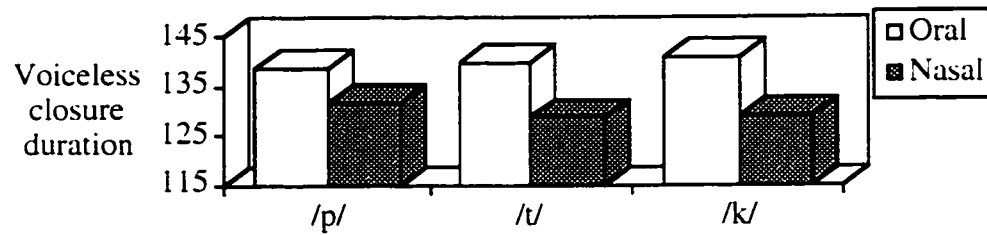

	/p/ significant		/t/ significant		/k/ significant	
	Oral	> Nasal	Oral	> Nasal	Oral	> Nasal
No. of tokens	36	36	42	42	36	36
Variance	0.40	0.27	0.26	0.51	0.46	0.18
Avg. voiceless closure (msec.)	138.88	131.69	139.89	128.76	140.76	128.93
	<i>df</i> = 1	<i>F</i> = 4.50	<i>df</i> = 1	<i>F</i> = 8.46	<i>df</i> = 1	<i>F</i> = 11.51
	<i>p</i> < 0.04		<i>p</i> < 0.005		<i>p</i> < 0.005	

4.3.4 A fixed property: Total period of voicelessness

The last finding I will report on concerns a fixed property of voiceless stops in oral and nasal contexts. Across the sample of data, it was found that the total period of voicelessness for stops does not differ significantly in oral versus nasal words. The values are given in (20) falling around 165 msec. ($p = 0.14$).

(20) Total period of voicelessness is not different: results across sample.

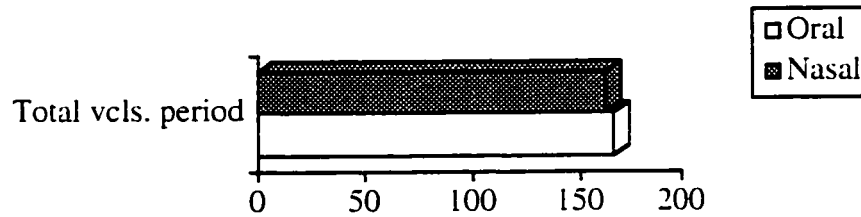

	Oral	Nasal	
Number of tokens	108	108	
Variance	0.51	0.40	
Avg. voiceless dur (msec)	166.31	162.27	$df=1, F=2.23, p=0.14$

Interestingly, when we compare the averages for total period of voicelessness by place of articulation, [k] is once again singled out in contrast to [p] and [t]. This is shown in (21). [p] and [t] conform to the generalization in (20), with no significant difference in their total voiceless period by oral/nasal context. [k], however, has a longer total voiceless period in oral words than in nasal ones. Further, the total period of voicelessness for [k] exceeds that of the anterior stops in oral or nasal environments.

(21) Total period of voicelessness by place of articulation.

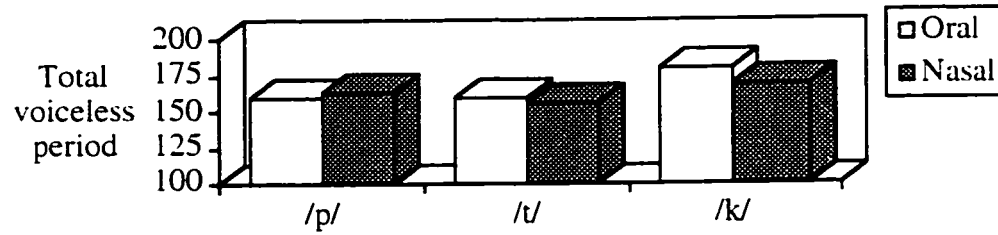

	/p/ not significant		/t/ not significant		/k/ significant	
	Oral	Nasal	Oral	Nasal	Oral > Nasal	Nasal
No. of tokens	36	36	42	42	36	36
Variance	0.48	0.26	0.26	0.55	0.56	0.25
Avg. voiceless duration (msec.)	159.48	163.16	160.27	155.41	180.56	169.04
	<i>df</i> = 1 <i>p</i> = 0.30	<i>F</i> = 1.11	<i>df</i> = 1 <i>p</i> = 0.23	<i>F</i> = 1.47	<i>df</i> = 1 <i>p</i> < 0.005	<i>F</i> = 10.3

To review, we have seen that overall the total period of voicelessness is not significantly different in oral versus nasal words, but when we take place of articulation into consideration, it emerges that [k] has shorter voiceless periods in nasal words. This is reminiscent of the threshold effect in the voice onset time which was hypothesized earlier for [k].

4.4 Discussion

I now will put the various findings together to construct an integrated picture of what timing changes take place in voiceless stops between nasal vowels. To begin, the chart in (22) synthesizes the correlation observed between the voiceless closure duration and voice onset time in oral versus nasal contexts for each place of articulation. In oral contexts the duration of voiceless closure averages about 140 msec. across all places. For the anterior stops [p, t], the VOT is about 20 msec. in oral tokens, and for [k], the average VOT is

considerably longer, at about 40 msec. In nasal tokens, these averages change so that voiceless closure decreases and VOT increases, except in the case of [k]. For [p] and [t], the average voiceless closure duration drops to about 130 msec. and the VOT increases to the neighborhood of 25-30 msec. The decrease in voiceless closure and corresponding decrease in VOT is apparent in the negative slope of the lines connecting the oral and nasal plots of these average values for [p] and [t]. In the case of [k] in nasal tokens, the average voiceless closure exhibits a fall to about 128 msec., matching that of the anterior stops; however, the average voice onset time remains essentially constant, holding at about 40 msec.

(22) Average voiceless closure plotted against average VOT

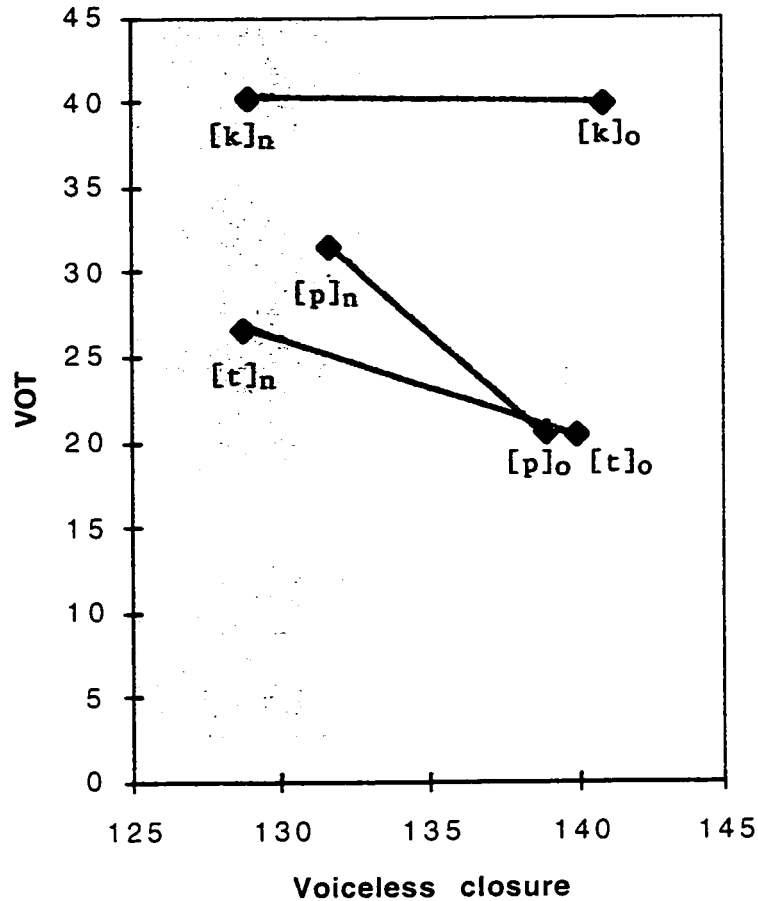

Legend: [p, t, k]_o = [p, t, k] (respectively) in oral context
 [p, t, k]_n = [p, t, k] (respectively) in nasal context

With these results in mind, I will turn to an interpretation of the findings. Timing in oral versus nasal environments in the VCV segment of the word is represented schematically in (23). Vertical lines on either side of the consonant (C) mark the points of initiation and release of closure, respectively. Below the VCV, zigzags signify voicing and a straight horizontal line represents voicelessness. A central finding of the study is that there is a fixed period of voicelessness for voiceless stops, which does not change across

oral and nasal environments. It may be that a fixed duration of voicelessness is a significant property for perception of voiceless stops, at least in Guaraní. In the oral word in (23), the voiceless portion is marked as the period (a) and in the nasal word it is marked as (b). (a) and (b) are equal in length — this property does not differ in oral and nasal words. What does change in nasal words is that the voiceless closure duration decreases, either because of a shorter closure ([p, k]) or longer closure voicing ([t]). The result is that to preserve the fixed duration of voicelessness, the voiceless period shifts to the right to extend farther into the following vowel. This produces the increased voice onset time in nasal words.

(23) Schematic representation of shift of voiceless period.

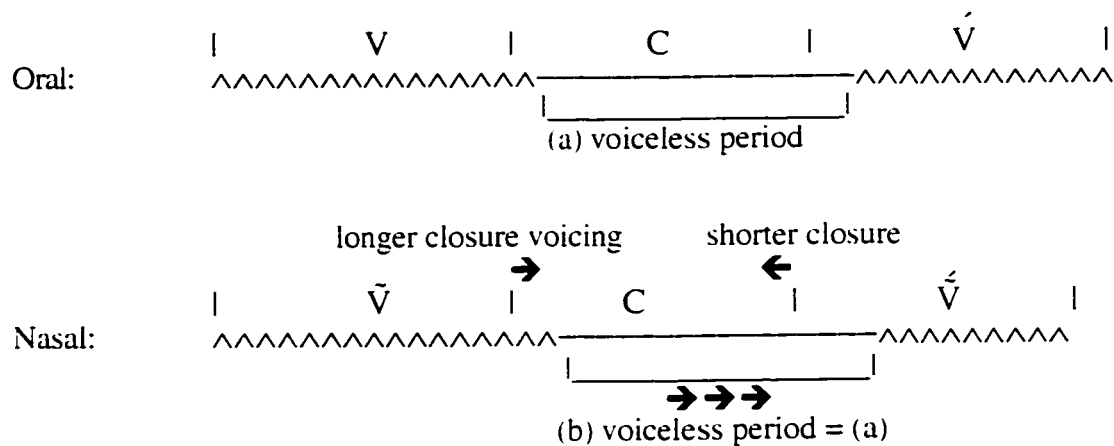

The above situation describes what has been observed for the anterior stops [p] and [t]. [k] behaves somewhat differently, and the schematic representations corresponding to this segment are shown in (24). Recall that of the three places of articulation, velars make the best voiceless stops: their back closure provides conditions producing the longest voice onset times. I have suggested that the voice onset time for [k] has reached a threshold in Guaraní, that is, it will not exceed about 40 msec.. This means that when the closure

duration for [k] is cinched in nasal environments, the voiceless period will not shift to the right, because it has reached the limit of its extension into the following vowel. As a result, the voiceless period (a) between oral vowels is greater than the voiceless period (b) between nasal vowels.

(24) Schematic representation of threshold effect for /k/.

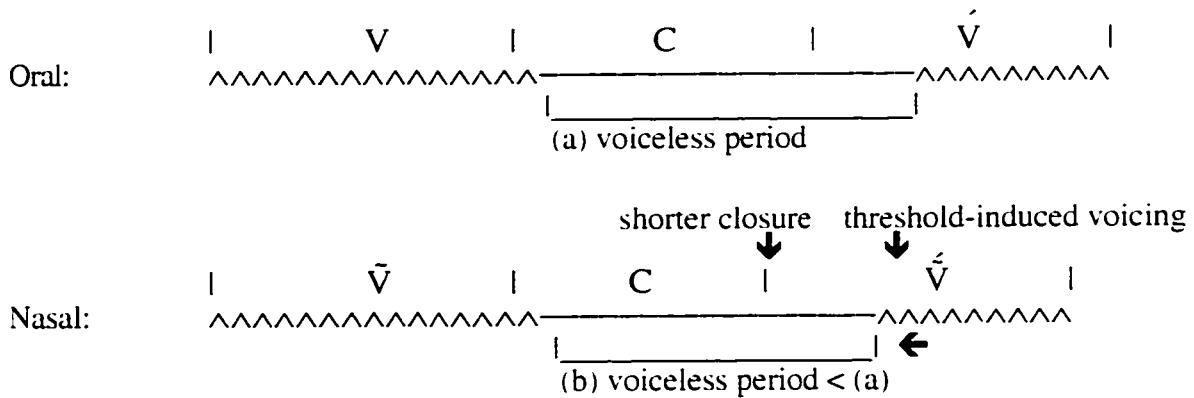

It was noted earlier that the threshold effect in the velar voice onset time could be one of *sufficient* length. From this perspective, the duration of post-release voicelessness would be sufficient to signal the voiceless quality of the stop, even under conditions of a shorter voiceless period during the closure. Avoidance of further intrusion on the vowel would then prevent a rightward shift in the voiceless period from taking place. The failure of the voice onset time of the anterior stops to meet the sufficiency requirement would explain the shift with these stops. It also is conceivable that the threshold is a result of velar voice onset times reaching a *maximal* length. Under this view, the threshold effect in the velar post-release voicelessness could be a consequence of perceptual factors. It may be that for adequate perceptibility of the stressed nasal vowel, the voiceless portion cannot exceed more than about 40 msec. It is also possible that a maximal threshold arises simply as an aerodynamic effect, whereby the relatively unobstructed airflow during the vowel

induces spontaneous voicing after no longer than 40 msec.. In either case, the conception of a threshold effect for [k] as the most robust voiceless stop explains why we see its separate behavior. [k] follows the core pattern of reducing closure duration between nasal vowels. However, since the velar stop does not extend its voice onset time, we do not find a difference in oral versus nasal words for voice onset time or the ratio of the closure to VOT. Also, because the voice onset time has reached its threshold, [k] must lose on preserving the length of its total voiceless period in nasal words, and so the total voiceless duration is shorter just in the case of velar stops.

This account explains differences in timing as a result of a shift of voicelessness to the right in order to maintain a fixed voiceless period, and the exceptionality of velar stops is interpreted as the consequence of a threshold effect for voiceless stops articulated with a back closure. The outcomes predicted under this account fit well with the data. A property that currently stands only as an observed characteristic is the decrease in the length of voiceless closure between nasal vowels. When this is achieved by an increase in closure voicing (in the case of [t]), this may be explained as a post-nasal voicing effect, which has been well-documented in the phonetic literature (see, for example, Westbury 1983; Westbury and Keating 1986; Ohala and Ohala 1991, 1993; Bell-Berti 1993; Hayes 1995; Pater 1996, in press; Hayes and Stivers in progress). In fact, the absence of a post-nasal voicing effect in the case of [p] and [k] after a nasal vowel is rather unexpected. In these stops, the decrease in duration of voiceless closure is instead produced by a shorter closure duration. The occurrence of shorter closures in nasal environments may be connected to the general finding across languages that nasal vowels are longer than their oral counterparts (see Whalen and Beddor 1989 and references cited therein). It is conceivable that the greater length of the nasal vowels produces a compensatory reduction in length of the onset consonant in Guaraní in order to maintain a more even syllable duration; adjustments of this kind in consonant and vowel length have been noted in English as part

of a general tendency to equalize the length of syllables (as noted by, for example, Ladefoged 1993; Laver 1994).¹²

The results of this study raise some other directions for future research. On Guaraní, it would be productive to replicate the study of timing effects in oral versus nasal words with a larger base of subjects in order to verify that the generalizations hold for the language. In other languages with contrasting oral/nasal vocalic environments, it would be worth investigating whether a fixed period for voicelessness occurs for voiceless stops. The findings of the present study suggest that a fixed voiceless period is a property that contributes to defining voiceless stops, at least in Guaraní. Further work is needed to determine whether this phonetic characteristic is universal or language-particular.

An interesting implication of the contextual variation in timing found in this work is that it confirms the need to characterize the phonetic implementation of phonological features as well as the overlap of articulations from one segment to the next (see, for example, Chomsky and Halle 1968; Pierrehumbert 1980; Browman and Goldstein 1986, 1989, 1990; Keating 1988, 1990; Cohn 1990, 1993a, b; Huffman 1990, 1993; Kingston 1990; Kingston and Diehl 1994. Öhman 1966, 1967 provides foundation). Various models of phonetic implementation have been proposed which map from an abstract phonological representation to a more concrete continuous sequence of timed articulations or gestures, and I will briefly consider the Guaraní results in relation to some of these models.

Some analysts have argued that the phonetic correlates of features are coordinated with other articulations in systematic ways. For example, Kingston's (1990) 'binding principle' posits a coordination between laryngeal features and stop consonant release. The binding principle is intended to constrain the possible timing of glottal articulations in

¹² Thanks to John Ohala for pointing out the possible connection of reduced length in onset consonant closure to the increase in nasal vowel duration.

relation to oral gestures, explaining why laryngeal features more frequently modify aspects of the release rather than the onset of closure. Huffman (1990) makes a related proposal in her investigation of the phonetic implementation of the feature [nasal]. Working in the windows framework of feature realization (Keating 1988, 1990; Cohn 1990), Huffman argues for the existence of ‘articulatory landmarks’ which fix the timing of nasality/orality (or other features) in relation to other articulatory events. In the case of oral stops, she finds that the property of orality ([-nasal]) is associated with the point of closure release. Nasal stops on the other hand have the property of nasality ([+nasal]) affiliated with the duration of the closure. The Guaraní data are consistent with both Kingston and Huffman’s proposals in that the point of release of voiceless stops in oral or nasal contexts was consistently oral and voiceless. The oral closures in these data, however, rule out a possible interpretation of voiceless stop transparency extending Huffman’s proposal in which the closure of the stop is nasal and only the release is oral.¹³ In regard to voice timing, recall from (14) that the variances for VOT in nasal tokens were found to be at least twice that in oral tokens at all places of articulation. If voice onset time is a function of when the glottis closes relative to the stop release, then this indicates that the coordination of the glottal closure and oral release is much more variable in nasal tokens. This significant a degree of difference in variance cannot be attributed simply to the increase in voice onset time in nasal words; further, this difference was specific to VOT: variances for closure durations did not differ systematically for oral versus nasal words (see (15)). Kingston (personal communication) suggests that the variability in nasal tokens may come about from the shift in the glottal articulation having become ‘unbound’ from the oral articulation. This unbinding could be caused by the shift in the glottal articulation from the onset of closure which takes place from the delay in glottal opening (occurring in [t]). This explanation posits a connection in the timing of the glottal articulation to both the onset and

¹³ Thanks to John Kingston for bringing this point to my attention.

release of closure. In the case of stops which have a shorter closure duration in nasal contexts, the earlier point of release and the shift of the glottal articulation to persist longer into the vowel may also unbind the glottal and oral articulations.

An important property of the phonetic implementation of [-voice] found in this study is that the duration of voicelessness remains fixed and shifts into the following vowel when the voiceless segment of the closure decreases. This kind of phonetic behavior indicates that it is not the case that the boundaries of the period of voicelessness are fixed in relation to oral gestures, rather there is some room for movement. This rightward shift of the voiceless gesture fits well with the representations of Articulatory Phonology, where glottal features are modelled as durational gestures arrayed on a tier for laryngeal articulations (Browman and Goldstein 1986, 1989, 1990). These may be coordinated with gestures on other tiers, but they have some flexibility in their timing. In nasal contexts in Guaraní, the early onset of release or increase in closure voicing pushes the voiceless gesture to the right, producing a greater voice onset time into the succeeding vowel. The relative independence of the laryngeal tier and the tier representing oral constriction readily reflects this kind of shift in the overlap from one segment to the next.

The need for some flexibility in phonetic implementation is also recognized by Kingston and Diehl (1994). In their work on the realization of the feature [voice], they find that phonetic implementation is governed by certain constraints, which limit the range of possible realizations; however, within this range, the speaker may control the outcome, balancing the demands of minimizing articulatory effort with listener-oriented maximization of perceptibility. If we take as a hypothesis that in the general case in Guaraní, a fixed duration of voicelessness is needed for perceptibility of voiceless stops, then the shift of the voiceless period when voiceless closure decreases can be characterized as a controlled adjustment to accommodate listener-oriented needs. This shift still obeys the constraint of

producing voicelessness at the point of release.¹⁴ In the case of [k], the voice onset time is conjectured to have reached a threshold. This threshold is listener-oriented if the voice onset time is understood to be sufficient to facilitate perception of the voiceless quality (and indeed, the voiceless quality of the [k] seems to be readily perceptible). If the threshold is instead understood as maximal, with voice onset as a consequence of aerodynamic factors, this would be a speaker-oriented effect. In either case, the fixed onset of voicing in the vowel following [k] is moderated by minimization of articulatory effort. Kingston and Diehl's notion of a speaker-controlled phonetics limited by certain principles and constraints thus provides a good framework in which to characterize the competing demands in the realization of Guaraní voiceless stops in nasal contexts as well as the contribution of these demands to the different outcomes for anterior versus velar stops. The Guaraní data show that some degree of flexibility in timing and an acknowledgement of various and sometime conflicting realizational requirements is necessary in any theory of phonetic implementation.

4.5 Two-burst events

In this last section, I outline a somewhat different pattern observed in the release of a small set of voiceless stops in nasal contexts. In these cases, the voiceless stops appear to have two rather than one events associated with the burst. Some sample spectrograms are given in (25) and (26) below.

The spectrogram in (25), which shows the VCV portion of [hãtã] 'hard' illustrates one kind of pattern seen in these exceptional tokens. Here there are two apparently separate burst spikes. In tokens like this, the burst spikes seem to be far enough apart to rule out an

¹⁴ It has been suggested to me by Bruce Hayes that the increase in the voice onset time in nasal tokens could be a consequence of a greater glottal abduction to inhibit post-nasal voicing. While this is an interesting factor to consider and certainly merits further investigation, the fixed duration of the voiceless period across oral and nasal tokens suggests that there is actually a controlled shift in glottal timing taking place.

occurrence of simply a sloppy burst (as, for example, was found in some tokens of [k]). The spectrogram for [pĩtũ] ‘dark’ in (26) shows a second kind of two-event production. Here the main burst spike is preceded by a period of energy, focused mostly in the higher frequencies.

(25) VCV portion of [hã'tã] 'hard'.

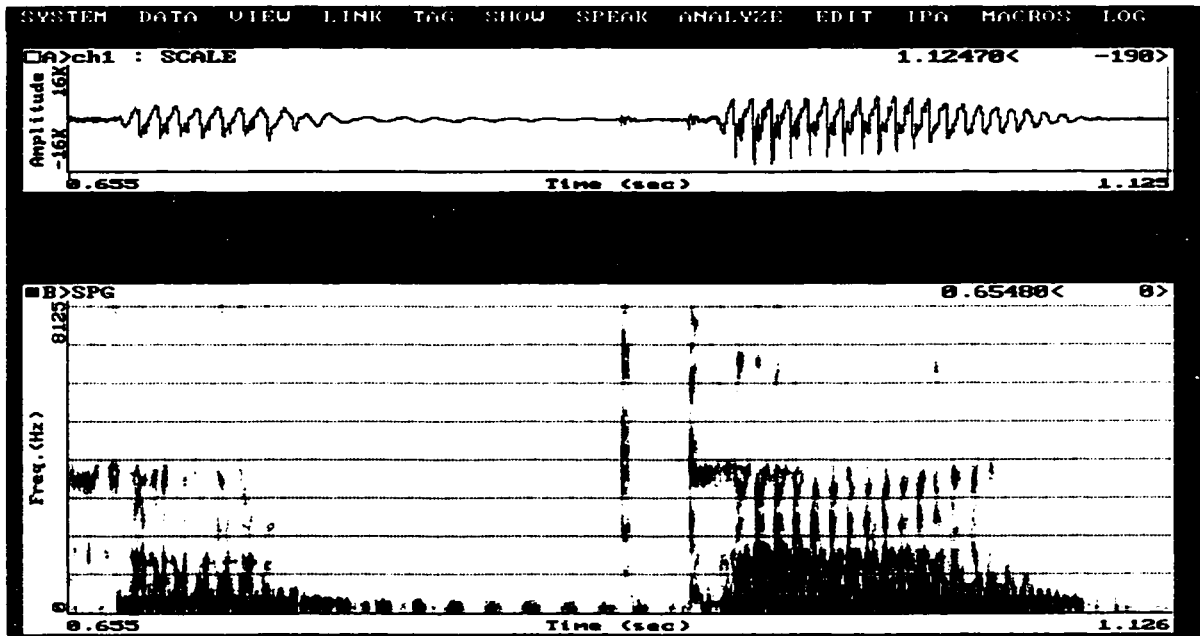

(26) VCV portion of [pɸ'tũ] 'dark'.

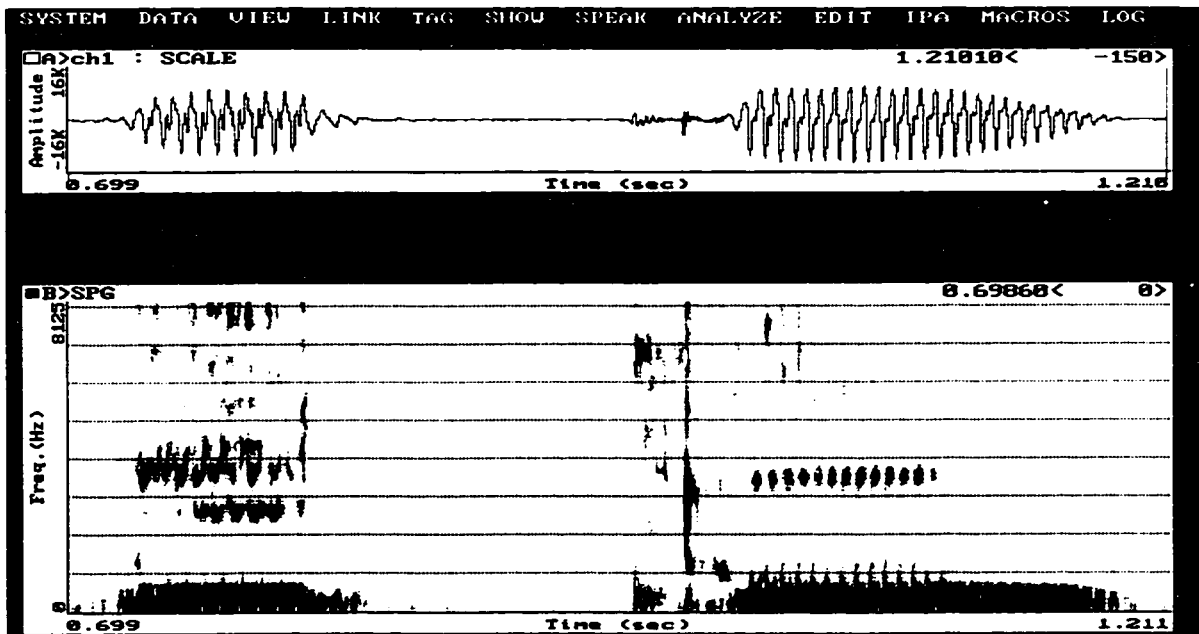

In both of the two-burst patterns, the second of the burst events displayed the characteristics of the usual release of the stop with the first burst apparently resulting from a brief breach in the oral closure; however, a fuller understanding of the articulatory action producing this first burst requires further investigation. Although it is not clear why, tokens exhibiting one of these different spectrographic patterns were restricted primarily to instances of [t] in nasal words. It should be noted that when this kind of pattern occurred, the duration from the initiation of closure to the second burst event was often longer than the regular one-burst-event tokens for [t]. Although the two-event pattern occurred in only some of the nasal words with [t], this increased length raised the average closure duration for [t] in nasal contexts and contributed to [t] being the one place of articulation that did not have shorter closures in nasal words (see (15)).

An intriguing feature of the two-burst phenomena is their apparent correlation to nasal tokens. It is conceivable that some aspect of the timing of velic closure and opening may contribute to these occurrences. In order to test the hypothesis that the two-event patterns are connected to the nasal context, it is necessary to make use of instrumental techniques which give more information about velum position during production of the stop. Photodetector devices, which register the relative amount of light that passes through an opening, would provide direct information about velic aperture (see, e.g. Ohala 1971 on the Nasograph; Dalston 1982). A less invasive alternative would be to measure nasal airflow (see, e.g. Benguerel 1974; Cohn 1990; Huffman 1990; Gerfen 1996). One of the most successful means of measuring airflow is with a split mask that covers the nose and mouth. The mask is divided to detect oral and nasal airflow separately, and a reading is achieved by directing the air into a device to measure air pressure, which is used to convert the differences in airflow into a varying electric signal. While this alternative may be more comfortable for the subjects, it only provides information about velum position to the extent that it may be extrapolated from nasal airflow readings: photodetectors give more direct

evidence. A variety of other investigative techniques are outlined by Krakow and Huffman (1993), and an instrumental study of Guaraní making use of one of these devices would be worthy project for future research.

4.6 Appendix: Word pairs

/p/

1.	/rupá/ /nupá/	[rupá] [nūpá]	'bed' (1st poss.) 'to hit'
2.	/djopí/ /popí/	[dʒopí] [pöpí]	'to itch, sting' 'to peel, strip'
3.	/kepé/ /mbopé/	[kepé] [möpé]	'asleep' 'he/she broke'
4.	/pepé/ /djepé/	[pepé] [ɲepé]	'to flutter, flap wings' (lit.) 'to break'
5.	/djapí/ /djapí/	[dʒöpí] [ɲāpí]	'to throw, shoot at' 'to cut hair'
6.	/hapí/ /ʃapí/	[hapí] [ʃāpí]	'to catch fire' 'defective, amputated, cut off'

/t/

1.	/kutú/ /pitú/	[kutú] [pítú]	'to stick (with), prick, strike' 'dark'
2.	/itá/ /itá/	[itá] [ĩtá]	'stone, rock' 'to swim'
3.	/mbotí/ /mbotí/	[mbotí] [mōtí]	'to close, shut' 'to cause shame'
4.	/potá/ /tetá/	[potá] [tētá]	'to want, desire' 'nation, country'
5.	/tatí/ /tatí/	[tatí] [tātí]	'daughter-in-law' 'horn'
6.	/patí/ /katí/	[patí] [kātí]	'name of a fish' 'stinking'

7.	/tatá/ /hatá/	[tatá] [hātá]	‘fire’ ‘hard’
/k/			
1.	/ʃuká/ /tuká/	[ʃuká] [tūká]	‘to show’ ‘toucan’
2.	/pokó/ /mokó/	[pokó] [mókó]	‘to touch’ ‘to swallow’
3.	/oké/ /oké/	[oké] [ōké]	‘to sleep’ ‘door’
4.	/hekó/ /hoké/	[hekó] [hōké]	‘custom, behavior’ (3 poss.) ‘door’ (3 poss.)
5.	/dʒoká/ /moká/	[dʒoká] [móká]	‘to break’ ‘to wipe up, wash’
6.	/kaká/ /haká/	[kaká] [hāká]	‘to defecate’ ‘branch’

Chapter 5

OTHER PROPOSALS

In this chapter I consider other proposals for the analysis of segmental transparency. The first of the alternative analyses is one calling on the gapped configuration. I argue that this alternative is weaker than the sympathy-based analysis proposed in the preceding chapters, because the sympathy-based approach obviates the need for transparency-specific gapped representations and brings segmental transparency into the larger realm of derivational opacity, a widespread phonological phenomenon with independent need for explanation. In addition, a gapping account offers no explanation for the asymmetry in blocking versus transparent outcomes for segments. In contrast, with the evaluation metric for opacity effects in grammar (discussed in 3.6), the sympathy-based account correctly predicts that blocking will be a less 'marked' outcome than segmental transparency for segments that are (gradiently) incompatible with nasalization. The second alternative I consider is the important representationally-driven account of nasal harmony proposed by Piggott (1992), where two different types of nasal harmony are posited. I argue that the fundamental advantage of the analysis of segmental transparency as an opacity effect proposed in the previous chapter is that it obtains a unified typology calling on only one basic type of nasal harmony. In addition, the unified analysis eliminates the need for any ad hoc representational assumptions. Finally, obviation of the gapped representation in the sympathy-based account offers an argument against further alternatives producing effects similar to gapping, such as violable feature expression or embedding of feature domains, which require parochial constraints to obtain segmental transparency.

5.1 A gapping alternative

I begin by considering an alternative calling on a violable NOGAP constraint, as in (1). This constraint prohibits linkage of a feature specification across an intervening segment. Because it is posited as violable in the alternative, which I will call the ‘gapping approach’, feature linkage may skip segments when compelled by a higher-ranked constraint.

- (1) NOGAP
 * $\alpha \ \beta \ \gamma$ where α , β , and γ are any segment.
 $\backslash \quad /$
 [F]

In nasal spreading contexts, NOGAP conflicts with the nasalized segment constraints. If NOGAP is dominated by a nasalized segment constraint, two outcomes are possible, either skipping of the segment for which nasalization is banned or blocking by this segment. The blocking outcome comes about if NOGAP dominates SPREAD[+nasal], as shown in (2) with a hypothetical form. Constraints against nasalized obstruents are collapsed here, as are constraints against nasalized sonorants. The bracketing in candidate (c) indicates that the [+nasal] linkage gaps across the [t]. Candidate (d) shows gapping across [t] and [l]. Here candidate (a), which respects both *NASOBS and NOGAP, wins over its competitors in (b-d), which fare better on spreading.

(2) Blocking: NOGAP >> SPREAD[+nasal]

	ātala	*NASOBS	NOGAP	SPREAD[+nas]	*NASSON
☞	a. [ā]tala			****	*
	b. [ātālā]	*!			****
	c. [ā[t]ālā]		*!	*	****
	d. [ā[t]ā[l]ā]		*!*	**	***

The tableau in (3) shows the skipping outcome. Here the reverse ranking of NOGAP and SPREAD[+nasal] holds. Once again, *NASOBS is respected in the winning candidate. Since NOGAP now dominates SPREAD, the winner, in (c), is the one which spreads [+nasal] to all of the segments except the obstruent. Note that candidate (c) incurs only one spreading violation. This is because in this form there is a single [+nasal] feature specification linked to all of the segments except [t], which is skipped. The candidate with blocking in (a) loses on SPREAD. We may observe that candidate (d), with skipping of both [t] and [l], loses by virtue of an extra spreading violation. In the optimal output, any segments whose nasalization constraints are dominated by SPREAD[+nasal] will undergo nasal spreading.

(3) Skipping: SPREAD[+nasal] >> NOGAP

	ātala	*NASOBS	SPREAD[+nas]	NOGAP	*NASSON
	a. [ā]tala		**!***		*
	b. [ātālā]	*!			****
☞	c. [ā[t]ālā]		*	*	****
	d. [ā[t]ā[l]ā]		*!*	**	***

The constraints and ranking shown in (3) illustrate the alternative gapping approach to segmental transparency. Like the analysis proposed in chapter 3, segmental

transparency is driven by nasalized segment markedness constraints (the analysis of transparency proposed by Kiparsky 1981 provides foundation for this approach, see also Archangeli and Pulleyblank 1994; Pulleyblank 1996). Where they differ is in the mechanism which obtains segment ‘skipping’ itself. In the gapping approach, this is achieved with a violable NOGAP constraint. However, the function of this constraint is specific to segmental transparency, it does no other work in the theory. In this respect, the gapping approach fails to offer an explanation for segmental transparency: under this account, transparency is a parochial phenomenon unconnected to other phonological events. On the other hand, by analyzing segmental transparency as the outcome of an opaque constraint interaction, the sympathy-based account brings transparency into the wider domain of opacity effects, a robust general kind of phenomenon in the phonology of languages. In addition, since the sympathy-based account makes use of independently-motivated mechanisms to obtain opacity effects and need not call on the gapped configuration, it fares better on theoretical economy than does the gapping approach.

A second drawback of the gapping approach concerns explanation of the cross-linguistic asymmetry in blocking versus transparent segments. Since the gapping approach obtains transparency through a rankable constraint, we expect that transparency of any portion of the nasalization hierarchy could be well-attested. The tableau in (4) illustrates a ranking in which all consonants behave transparent and vowels undergo nasalization.

(4) Skipping of all consonants

	ātala	*NASOBS	*NASAPPROX	SPREAD[+nas]	NOGAP	*NASV
a.	[ā]tala			***!*		*
b.	[ātālā]	*!	*			***
c.	[ā[t]ālā]		*!	*	*	***
d.	[ā[t]ā[l]ā]			**	**	***

In the tableau in (4), constraints banning nasalized approximants (collapsed here) move up to dominate NOGAP. This produces transparency of both [t] and [l] in the optimal output, an outcome which was not found in the cross-linguistic survey of nasal harmony. To limit transparent outcomes to obstruents alone, the gapping approach would require the fixed ranking in (5), which stipulates that NOGAP must always dominate *NASLIQUID (and by implication all lower-ranked nasalization constraints). NOGAP could thus only be dominated by constraints against nasalized obstruents, limiting transparency to this set of segments.

(5) NOGAP >> *NASLIQUID

The problem with this account of the limited set of segments that may behave transparent is that it does not offer any explanation for this limitation. The restriction of transparency to obstruents is simply a stipulation. Under the sympathy-based approach, this issue is handled by the evaluation metric for opacity effects (see section 3.6). By this evaluative measure, the cross-linguistic asymmetry between sets of blocking and transparent segments is explained by transparency as an opacity effect presenting a more difficult learning task. The posited increase in learning difficulty as more segments are added to the transparent set (by shifting more of the nasalization constraint hierarchy to P1)

also contributes to the understanding of the limitation of transparency to obstruents. The sympathy-based account thus connects the asymmetry in sets of transparent and blocking segments to differences in the kind of mechanisms producing these outcomes. The gapping approach obtains both outcomes from straightforward constraint ranking, and thus must stipulate differences in the robustness of the effects. One could imagine embellishing the theory with a learning claim that the more segments that are gapped, the harder the language is to learn, but this would amount to a separate learning claim unrelated to anything else.

5.2 The variable dependency hypothesis

In his important cross-linguistic study of nasal harmony, Piggott (1992) makes an interesting proposal: there is not one but *two* types of nasal harmony in the languages of the world. The two types of nasal harmony patterns he posits have the following different properties. In the *blocking* pattern (Piggott's 'Type A') segments are divided exhaustively into sets of targets or blockers; there are no transparent segments. The blocking segments are a subset of the consonants which includes the obstruent stops, with hierarchical variation in the set of targets according to the implicational hierarchy outlined in chapter 2.¹ On the other hand, in the *transparency* pattern (Piggott's 'Type B'), all segments are divided into sets of targets or transparent segments — no segments block spreading. Transparent segments are obstruents and the remaining segments are targets; voiced stops may belong to the latter set.

Piggott's proposal that there are two different kinds of nasal harmony is driven by his theoretical grounding. Piggott assumes a representationally-driven, feature-geometric

¹ Piggott (1992) obtains the effect of hierarchical variation in the set of targets from the 'Contrastive Nasality Principle' that he proposes. See Walker (1995) for empirical and theoretical arguments preferring a nasalized segment constraint hierarchy over the Contrastive Nasality approach.

approach, and he adopts standard assumptions concerning segmental transparency and locality in this framework. Reasoning within this analytical model, he is led to the conclusion that there cannot be just one basic type of nasal harmony and he suggests a very interesting innovation: the two patterns arise from variable dependency across languages for the feature [nasal] in the feature geometry. The approach is sketched below. First (6) illustrates the segment structure Piggott (1992: 53) posits for nasal spreading in a language with transparency harmony, i.e. one in which all voiced segments are targets and voiceless obstruents are transparent. The account follows the standard feature-geometric assumption that locality is relativized to tiers, so that spreading must be between target nodes that are adjacent on their tier. This allows for segmental transparency if a segment is not specified for the target node in its structure. In transparency harmony, obstruents are transparent, so they must not contain the target node of spreading. Piggott suggests that in these languages [nasal] is a dependent of a 'Spontaneous Voicing' (SV) node, which is present in all sonorant segments and absent in obstruents. Spreading of [nasal] between SV nodes thus yields an outcome in which all sonorants are targetted and all obstruents are skipped. (6) shows this for Piggott's analysis of Southern Barasano (Tucanoan; Colombia). ('R' represents a root node.)

(6) Transparency in Spontaneous Voicing (SV) node spreading

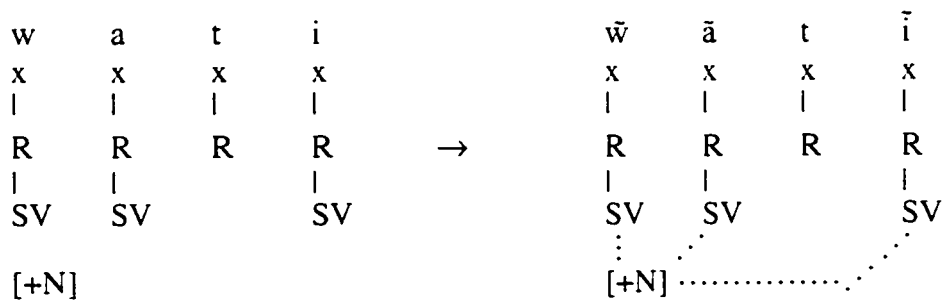

In the majority of languages with the transparency kind of nasal harmony, voiced stops undergo nasal harmony. Since [nasal] can occur only in the representation of sonorants in these languages, Piggott proposes that voiced stops undergoing nasal harmony belong to the set of sonorants (see also Rice 1993). Piggott observes that in languages like Southern Barasano there is no phonemic contrast between voiced and nasal stops, and he posits the voiced stops as representing a series of sonorant stops in the inventory with context-dependent nasal or oral realizations.

In the case of the blocking type of nasal harmony, rather than behaving transparent obstruents always belong to the set of blocking segments. This is not obtained by a structure for obstruent stops like that in (6), because these stops lack the target node and are thus expected to be skipped in spreading. For the blocking outcome, Piggott calls on the standard autosegmental assumption that line crossing is prohibited (Goldsmith 1976), and so blocking comes about when a segment is already specified for the kind of structure that is spreading. Piggott proposes that segment structure in the blocking kind of nasal harmony differs from transparency harmony in having [nasal] as a dependent of a Soft Palate (SP) node (after Sagey 1986), which is specified underlyingly in (some) consonants. Piggott analyzes blocking harmony as spreading of the Soft Palate node from root node to root node, so only segments underlyingly unspecified for a Soft Palate node will be targets and all other segments will block spreading. This is shown in (7) (From Piggott 1992: 38 on Warao, a language of Venezuela).

(7) Opacity in Soft Palate (SP) node spreading

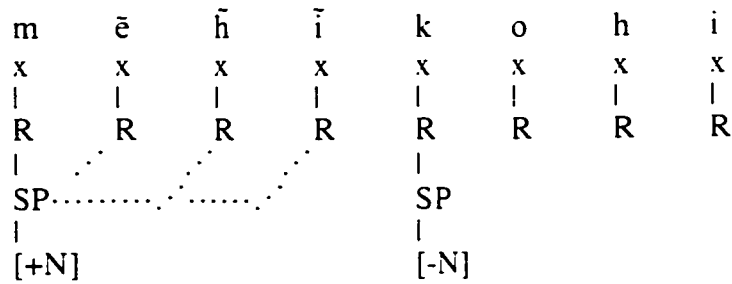

Variability in the set of undergoers is analyzed as variability in the set of segments which are specified underlyingly for the Soft Palate node (governed by Piggott's Contrastive Nasality Principle). This set will be a subset of the consonants which includes the obstruent stops.

A driving force behind Piggott's analysis is the assumption that transparency occurs when a segment is skipped. With this assumption, Piggott argues that the transparency systems cannot be unified with the opacity ones, because if transparency harmony involved spreading of the Soft Palate node, the transparency of voiceless obstruents could not be explained. He points out that for voiceless obstruents to behave transparent, they would have to be unspecified for the Soft Palate node underlyingly; but this would simply make them into targets for the spreading of the Soft Palate node, and they would then be expected to undergo harmony rather than be skipped.²

Piggott thus posits two types of nasal harmony which differ in the node that spreads and in the dependency of [nasal]. Given the theoretical grounding in the assumptions of the representational-driven framework, the conclusion that there are two types of nasal harmony is the best possible account that is available. To restrict the variable

² Note that calling on a parametrized specification of prosodic anchors, such as targetting of the mora (Archangeli and Pulleyblank 1994; Pulleyblank 1996), would not be successful in obtaining the needed transparency here. Both moraic and non-moraic segments act as targets in nasal harmony transparency patterns, and so a representationally-driven account must look at structure internal to the segment rather than above it. But see Piggott (1996) for a proposed suprasegmental approach to some nasal harmonies.

dependency for [nasal], Piggott suggests that the difference in segment structure is parametrically determined, with [nasal] as a dependent of the Soft Palate as the unmarked option (1992: 51). The Spontaneous Voicing node affiliation for [nasal] is selected when there is no underlying contrast between voiced stops and nasals in the language. This parametric SP-node hypothesis makes a strong claim: it connects the transparent or blocking behavior of stops to the structure of the stop inventory of the language in a very particular way. It predicts that blocking harmony will occur only in languages where there is a contrastive distribution for voiced and nasal stops. However, this is not the case. a language we have already seen in chapter 2 provides a counter-example; this language is Epena Pedee (Choco; Colombia). Harms (1985, 1994) points out that Epena Pedee has three series of stops: voiced, voiceless unaspirated, and voiceless aspirated, as given in (8). The language does not have a contrastive distribution between voiced oral and nasal consonants: the realization of voiced stops as oral or nasal is predictable from context.

- (8) Epena Pedee stops
- | | | |
|----------------|----------------|----------------|
| p ^h | t ^h | k ^h |
| p | t | k |
| b/m | d/n | g/ŋ |

Since there is not a distinct series of nasal stops in the inventory structure of Epena Pedee, the parametric SP-node hypothesis predicts that the language will choose the Spontaneous Voicing structure for [nasal] and thus exhibit a transparency-type of nasal harmony. In fact, voiced and voiceless stops block left-to-right nasal spreading from a nasal vowel, as shown in (9). (A regressive syllable-bound nasal harmony which nasalizes all segments except voiceless stops is also apparent here; this was discussed in section 2.3.)

- (9) Epena Pedee
- | | | | |
|----|------------------------|--------------------------------------|------------------------------------|
| a. | /perōra/ | [peřōřā] | ‘guagua’ (a groundhog-like animal) |
| b. | /dāwe/ | [nāwē] | ‘mother’ |
| c. | /ūbuisi/ | [ʔū ^m buisi] | ‘neck’ |
| d. | /wāhida/ | [wāhī ⁿ da] | ‘they went’ (go+past+plural) |
| e. | /k ^h isia/ | [k ^h i ⁿ siə] | ‘think’ |
| f. | /hōp ^h e/ | [hō ^m p ^h e] | ‘a species of fish’ |
| g. | /wāit ^h ee/ | [wāi ⁿ t ^h ee] | ‘go’ (future) |

The problem that Epena Pedee presents for the parametric dependency account concerns the details of the connection between inventory structure and harmony type. Piggott suggests that when voiced oral and nasal stops do not contrast in an inventory, [nasal] is relevant for sonorant segments only, i.e. under these circumstances, [nasal] spreading will target only sonorant segments (via the SV node). Epena Pedee falsifies this claim. In addition, the blocking behavior of voiced stops in cross-morpheme spreading in Tuyuca (discussed in 3.3.4) provides evidence that voiced stops undergoing nasal harmony in a transparency-type of harmony can be true obstruents in their underlying character. In contrast, the unified analysis of nasal harmony is not presented with these problems. Because the nasalized obstruent constraint is violable, it need not posit voiced stops as underlyingly sonorants when they are targetted in nasal harmony. Also, since it does not rigidly tie blocking and transparency to inventory structure, it actually predicts the occurrence of a language like Epena Pedee in which voiced and voiceless obstruent stops block nasal harmony: the lack of a contrastive nasal series of consonants presents no problem.

Independent of the particulars of assumptions about inventories, the variable dependency analysis is faced with two more general kinds of drawbacks. The first point

concerns the ad hoc nature of the representational solution. To distinguish the two patterns, variable dependency must be stipulated for [nasal]; however, there is no independent motivation for the variable dependency of [nasal] or for other features. The second point concerns asymmetries in the potential sets of transparent segments, target segments, and blocking segments. By positing two different types of nasal harmony, the variable dependency account offers no explanation of the complementarity between segments that can undergo nasalization and those that behave transparent. We have seen that *all segments* have the potential to block nasal spreading. Further, all segments *except obstruents* have the potential to undergo nasal harmony (pattern as targets), and *only obstruents* ever act transparent. This complementarity is a flag that target and transparent segments are different realizations for one kind of segmental patterning, namely undergoers of nasal harmony. This is the line of explanation taken in the unified account proposed in chapters 2 and 3, leading us to the finding that with respect to the feature [nasal], Universal Grammar gives us one basic kind of language, not two.

5.3 Other approaches to segmental transparency

Some recent approaches to segmental transparency in an optimality-theoretic framework move away from claims about the organization of features in transparent segments and instead focus on the possibility of interrupting the domain of a feature that has spread across a span of segments (e.g. Smolensky 1993; Cole and Kisseberth 1994, 1995). The idea unifying these accounts is that the domain of a feature specification can cover a continuous span of segments (e.g. all of the segments in a word), but the realization of this featural property on all of the segments within this domain is violable, with a mark incurred for each segment realized with an opposing feature specification (similar in spirit to the gapping approach considered in 5.1). Smolensky (1993) formulates this violable constraint as *EMBED, which prohibits the occurrence of a root node parsed into a feature

domain embedded within another of an opposing specification: for example, *EMBED_[-nasal] bans the occurrence of [-nasal] within a span of [+nasal] segments. This is illustrated by the representation in (10).

(10) An embedded feature domain structure:

[_{+N} \tilde{w} \tilde{a} [_{-Nt}] \tilde{i}]

The structure in (10) will incur one violation with respect to *EMBED_[-nasal] for the occurrence of [-nasal] [t] within the [+nasal] span of segments from [\tilde{w}] to [\tilde{i}]. The violation of *EMBED can be compelled by a segmental markedness constraint, such as *NASOBSSTOP. A related line is taken by Cole and Kisseberth (1994, 1995) with their constraint, EXPRESSION, which requires that a phonetic feature [F] must be expressed on every element in an F-domain. This take on segmental transparency posits the domain of [+nasal] as spanning the entire word in [_{+N} \tilde{w} \tilde{a} \tilde{i}], with EXPRESSION violated by [t], again driven by the markedness of nasalizing this segment.

Like the NOGAP approach considered earlier, these accounts have in common with the sympathy-based analysis I have proposed the idea that segmental transparency is driven by markedness constraints; i.e. a segment behaves transparent in order to avoid the occurrence of some dispreferred feature combination. The way in which these accounts differ from the sympathy-based approach is that they call on constraints specific to segmental transparency (e.g. *EMBED, EXPRESSION) in order to obtain the surface-transparent outcome. These constraints do no other work in the grammar other than obtaining segmental transparency. In contrast, the analysis of segmental transparency as a derivational opacity effect makes no use of parochial representational configuration or device such as embedding, feature expression, or gapping. Outside of Faith, the analysis of nasal harmony calls only on constraints on feature cooccurrence and spreading.

Transparency is achieved through sympathetic faith, a mechanism independently-motivated for the widely attested range of phenomena known as opacity effects in phonology. On the grounds of theoretical economy, the analysis of segmental transparency as an opacity effect is thus to be preferred. It is conceivable, however, that an approach might be developed which utilized *EMBED (or perhaps EXPRESSION) to capture a broader range of phonological phenomena, for example, if the notions underlying embedding or feature expression could be elaborated to extend to other kinds of derivational opacity, then this would be an interesting alternative to pursue, and one generally in harmony with the analysis proposed here.

In his recent analysis of vowel harmony, Pulleyblank (1996) also argues against using an ad hoc representational configuration, such as gapping, to obtain segmental transparency. The representations Pulleyblank assumes for words with transparent segments are similar to those proposed under the account proposed here, with a separate occurrence of a feature specification on either side of the transparent segment. For example, a word with a high [ATR] vowel transparent to [RTR] harmony has an output representation like that in (11). (I set aside here the question of whether the vowel features should be linked to the consonants as well, see Ní Chiosáin and Padgett 1993, 1997 for discussion.)

(11) Representation of segmental transparency in [RTR] harmony

[RTR]	[ATR]	[RTR]
		/ \
t	ε	k k i l ε ε n

To realize this kind of outcome, Pulleyblank does not analyze segmental transparency as a kind of derivational opacity, rather he proposes to interpret violations of the constraint

driving spreading in a certain way. Assuming that feature alignment to the morpheme or word edge is the spreading imperative for harmony. Pulleyblank suggests that constraint evaluation is 'locally-determined' (1996: 325-326). Informally he describes this as meaning that the local domain for some feature specification [F] is the class of segments that could be associated to [F] without producing line crossing (an ill-formed representation; Goldsmith 1976). Consider the representations in (12). The set of segments to which [+nasal]_i could potentially be linked without producing line crossing are (A-E); these are the 'local domain' for this occurrence of [+nasal]. Segment (G) is not in the local domain for [+nasal]_i, since linking this feature occurrence to (G) would produce line crossing. As a consequence, under local evaluation, rightward alignment for [+nasal]_i is violated for segments (B-E) in (12a) for [+nasal]_i and it is fully satisfied for [+nasal]_i in (12b). [+nasal]_i incurs one violation with respect to rightward alignment in each case.

(12) Local domains

a. [+nasal] _i [+nasal] _j	b. [+nasal] _i [+nasal] _j
	/ / \ \
A B C D E F G	A B C D E F G

What this means for spreading is that sprouting feature occurrences on the other side of a transparent segment can fair better on alignment than a blocking outcome. Evaluated with respect to local domains, (13a) with segmental transparency will incur one violation on rightward spreading for [+nasal], but (13b) with blocking will incur two violations.

(13) Local domains in nasal spreading

a. [+nasal] [+nasal]	b. [+nasal]
/ \	/ \
w̃ ā t ī	w̃ ā t i

Pulleyblank's approach to segmental transparency is a very interesting one, and of the alternatives, it is most closely in harmony with the understanding of locality argued for in chapters 2 and 3. In applying the local domain interpretation of alignment to nasal harmony there are questions about the assumptions it would require concerning the binary versus monovalent status of features, although I will not pursue those issues here. There are two general reasons for preferring the derivational opacity account. The first comes back to the matter of theoretical economy. Analyzing segmental transparency as an opacity effect obviates the need for restricting constraint evaluation to local domains. Adding the local domain requirement to the evaluation of alignment constraints builds a further degree of complexity into the computation: not only must reference be made to the edge of the M_{Cat}, but also to boundaries within the M_{Cat} circumscribing the limits of alignment without line crossing. A theory of derivational opacity is independently required, and so the assumption of this complex kind of local domain evaluation need not be invoked. The second point concerns the matter of learnability noted in 5.1. Analyzing segmental transparency as an opacity effect posits transparency as a more 'marked' outcome for incompatible segments than blocking, as given by the evaluation metric outlined in 3.6. It thus contributes to the explanation for the greater range of segments exhibiting blocking in nasal harmony. Alternative accounts which derive segmental transparency simply through constraint ranking without derivational opacity offer no insight into why blocking of spreading is a more common outcome in general than transparency.

Chapter 6

OTHER PHENOMENA: REDUPLICATION AND COOCCURRENCE RESTRICTIONS

In this chapter I examine two cases of nasal agreement which may at first be mistaken for nasal spreading but I argue have properties identifying them as other kinds of phonological phenomena. The first is a case of nasal agreement in Mbe affixation (Bamgbose 1971), which I show to be an example of reduplication. Evidence for this conclusion is compiled both cross-linguistically and on the basis of a detailed analysis of various morpho-phonological phenomena in the language. The second is a condition of long-distance nasal agreement holding within and across morphemes in certain Bantu languages (Ao 1991; Odden 1994; Hyman 1995; Piggott 1996). I claim that this should be classified as an example of a cooccurrence restriction, paralleling a set of other languages in which cooccurrence restrictions over segments having similar but different properties are resolved by substitution of an identical feature rather than dissimilation. The direction for the cooccurrence analysis is sketched and the details are left for further research.

6.1 Reduplication in Mbe

In this case study of Mbe nasal agreement, I argue that what has been (atheoretically) termed 'nasal harmony' in Mbe (Bamgbose 1971) is in fact a case of reduplication in which material is copied as a nasal coda to a prefix with place features linked to the following onset; if place linking fails, no copy occurs. I demonstrate that this account is motivated on the basis of various other phenomena in Mbe, and it has implications illuminating the theory of reduplication. First, the place-linked nasal status of the copied segment is independently-motivated by conditions on Mbe syllable structure. Second, the size restriction on the reduplicant can be simply obtained through an atemptatic alignment constraint, *AllSyllableLeft*, utilized in a ranking producing *The Emergence of the*

Unmarked (acronymically TETU; McCarthy and Prince 1994b; size-restrictor ranking after Spaelti 1997 with foundation in proposals of McCarthy and Prince 1994a; Prince 1996, 1997). This templatic account of size-restriction does work elsewhere in the language in limiting the size of other prefixation, both reduplicative and non-reduplicative. Further, I show that alternative templatic approaches to size restriction are both insufficient and not required. TETU rankings as an analytical mechanism are pervasive in the account, playing a role not just in the analysis of size restriction but also in the analysis of reduplication in a second clearly reduplicative prefix.

Another issue that is addressed is the possibility of prespecification in reduplicative affixes. Analyzing prefixes exhibiting nasal agreement in Mbe as reduplicative would seem to require admitting prespecified segments in reduplication; however, evidence from Mbe morphology is adduced to show that what appears to be prespecified material in fact belongs to a separate prefix. The analysis thus supports the claim that fixed segmentism in reduplication is not prespecified but is either phonologically-determined (i.e. default; derived through TETU rankings) or morphologically-determined (what McCarthy and Prince term 'melodic overwriting')¹ (McCarthy and Prince 1986, 1990; Urbanczyk 1995, 1996a, b; Alderete et al. 1996; Spaelti 1997). A more general proposal is introduced to eliminate the emergence of prespecified material in reduplicative affixes from an extension of the Root-Faith >> Affix-Faith metaconstraint (McCarthy and Prince 1994a, 1995).

The organization of this section is as follows. First, in section 6.1.1 I present the nasal agreement data in diminutive prefixation and present arguments that it is not nasal spreading and should instead be regarded as reduplication. The next section gives evidence supporting this claim, showing that syllable-size imperative reduplication exhibits a similar

¹ Building on McCarthy and Prince (1986), Alderete et al. (1996) suggest that melodic overwriting can occur when RED competes with another morpheme for the same space. Spaelti's (1997) 'syllable recycling' builds on a somewhat similar idea, while seeking to explain what enforces the anchoring violation in the output shape of RED.

nasal agreement effect. An analysis of imperative reduplication is developed, and then in section 6.1.3, this analysis is extended to diminutive prefixation. Evidence is given to show that prefixation in diminutive nominals is complex, consisting of a purely reduplicative affix and a separate non-reduplicative segmental affix; an alternative single reduplicative affix with prespecified material is insufficient. It is argued that what distinguishes the syllable-size reduplication in the imperative and coda/null size reduplication in the diminutive is simply the ranking of morpheme realization constraints. In 6.1.4, the analysis of diminutives is extended to nasal agreement in the formation of inchoative verbs. Section 6.1.5 gives data from Zoque which shows that a morpheme realization constraint is violated under similar phonological conditions in another language. 6.1.6 examines the role of the atemplatic size-restrictor constraint in other affixation in Mbe, and 6.1.7 presents arguments that templatic alternatives are inadequate. Finally, section 6.1.8 addresses the general question of prespecification in reduplication and develops a proposal to eliminate prespecification effects, and 6.1.9 forms an appendix, presenting a constraint hierarchy which derives the coda condition in Mbe.

6.1.1 Nasal agreement in diminutive nouns

Mbe is a Benue-Congo language spoken in the Ogoja Province of Eastern Nigeria. Mbe exhibits a remarkable nasal agreement effect, whereby a nasal occurs in the coda of certain prefixes only when the stem contains a nasal. The phenomenon and other aspects of Mbe morphology are described in a series of papers by Bamgbose (1966a, 1967a, b, 1971); additional comments on the phonology of Mbe appear in Bamgbose (1967c).² I begin by examining nasal agreement in the formation of diminutive nouns and return later to nasal agreement in the formation of two verbal tense/aspects.³

² Thanks to John McCarthy for first bringing the Mbe facts to my attention. I am grateful to Akin Akinlabi for help in finding the body of descriptive work on Mbe.

³ A third case of nasal agreement in the formation of perfective verbs is discussed in the appendix (6.1.9).

Singular diminutive nominals are usually formed with a prefix of the form [ke-] (see second column in (1)). Vowel harmony produces a [ka-] variant before syllables containing [a]. In their non-diminutive form, nouns occur not as a bare root but with a prefix marking number category (singular or plural; see first column in (1)). Mbe is a 'class' language with seven primary nominal classes, four of which contain two secondary classes. The class to which a noun belongs determines which number category prefix it will take, as well as the form of syntactic agreement markers in verbs and in concord markers (thematic, qualifying, demonstrative, deictic, third person non-human object, and genitival). Comparison of the two columns in (1) reveals that tonal changes also take place in diminutive formation. The diminutive tonal patterns are complex and will not be analyzed here.⁴

(1)	<u>Singular noun</u>	<u>Diminutive singular</u>
a.	bù - t̃í sg.- head	kě - t̃í dim. sg.- head
b.	lè - béI	kě - béI
c.	bè - líe	kě - líe
d.	è - fúfú	kè - fúfú
e.	è - kíkèl	kè - kíkèl
f.	lè - bàrò	kà - bàrò

⁴ The diminutive tonal patterns are as follows (after Bamgbose 1966a: 49-50; using abbreviations and diacritics: L-low [`], H-high [´], R-rising [˘], F-falling [ˆ], D-Downstep [']). With monosyllabic nouns, the diminutive prefix is R; H-stem becomes F and L-stem becomes H. With disyllabic nouns, HH is unchanged, HL becomes FL or HL, LH becomes RF, LL is unchanged or becomes RH. With nouns over two syllables, stem tones remain unchanged and the diminutive usually takes the initial tone of the noun, although some L-initial nouns take a R-diminutive prefix.

The above data show the formation of the diminutive when the noun stem contains no nasal segmental material. If the noun contains a nasal, the diminutive is formed as above but closed with a nasal stop which is homorganic with the following onset:

(2)	<u>Singular noun</u>	<u>Diminutive singular</u>
a.	è - bàṃ 'bag'	kàṃ - bàṃ 'little bag'
b.	bù - mù 'story'	kèṃ - mù 'little story'
c.	—	kàṃ - fàṃ 'little path'
d.	bù - tèṃ 'heart'	kèṃ - téṃ 'little heart'
e.	è - rèn 'fruit'	kèṃ - rén 'little fruit'
f.	lè - léṃ 'tongue'	kèṃ - lêṃ 'little tongue'
g.	kè - nèn 'bird'	kèṃ - nèn 'little bird'
h.	lé - fíání 'work'	kán - fíání 'little work' ⁵
i.	—	kèṃ - níén 'little thing'
j.	ó - kùòm 'snake skin'	kéṃ - kùòm 'little snake skin'
k.	é - ḡbénó 'upper arm'	kéṃ - ḡbénó 'little upper arm'

It is reasonable to question what kind of phonological mechanism produces this kind of nasal agreement effect. Is it spreading? Segment copying (i.e. reduplication)? The nasal agreement has properties which argue against this being a case of [+nasal] spreading. First, there is no alternating target segment, rather there is an alternation between the occurrence of a nasal segment and zero. Feature spreading does not induce the appearance of a new segment but affects the featural properties of a segment already present. We might speculate that the nasal agreement actually represents a featural alternation in the onset consonant in the form of prenasalization; however the coda status of the nasal is

⁵ Bamgbose (1971: 10) notes that nasals are realized as [n] before [f, tʃ, dʒ] and as [ŋ] before [j, ɲ].

supported by its triggering a vowel reduction known to take place in the context of closed syllables (Bamgbose 1971: 104). Also, prenasalized consonants do not occur generally in the language. Another reason to reject a spreading analysis is that the nasal agreement is non-local, that is, the dependent nasal and the stem nasal may be at any distance in the word. In the preceding chapters we have seen persuasive evidence that [+nasal] spreading (and feature spreading in general) occurs only between adjacent segments. In the cross-linguistic survey of nasal harmony summarized in chapter 2, spreading of [+nasal] between segments at an unlimited distance is unattested.

Given these arguments we are left with the possibility that Mbe nasal agreement is produced by reduplication. But this does not look like a typical case of reduplication. Reduplicative affixation usually copies at least a syllable (or an onset plus default vowel); yet in this case, material is copied as a coda or fails to be copied at all. There also is a fixed segmental component to the formation of diminutives ([kɛ-]), which may seem to suggest that the prefixation is not reduplicative; indeed the fixed segmentism has led a previous analyst to reject the possibility of a reduplication account (Bamgbose 1971: 102).⁶ On the other hand, the nasal agreement has properties consistent with it being reduplication. The limitation of nasal agreement to the formation of specific morphemes is expected if this is a reduplicative phenomenon. Also expected is the dependency of affix segmentism on root material, i.e. the occurrence of the affix nasal is conditioned by the occurrence of a nasal in the root.

Based on the arguments against spreading and the properties consistent with segment copying, I come to the interim conclusion that the nasal agreement is an instance of *reduplication*, not nasal feature *spreading*. In the remainder of this section I will show that

⁶ Bamgbose (1971: 105) proposes to treat the harmonizing nasal as a 'phonetic element' introduced by a non-phonological rule: CV-CVN(V) → CV + n-CVN(V).

analyzing nasal agreement in Mbe as nasal copy is both plausible and motivated, and it has important implications for the theory of reduplication.

6.1.2 Nasal copy in imperative verbs

Independent evidence for the nasal agreement phenomenon as a case of nasal copy comes from a pattern of reduplication occurring in imperative verbs in Mbe. Verbs in Mbe are categorized as Class 1 or Class 2, corresponding to the particular form of affixation or reduplication that takes place in verbal inflection. Imperative verbs can be either simple (non-reduplicated) or reduplicated. Reduplication in imperative verbs exhibits a similar kind of nasal agreement to that seen in the diminutive. The pattern of reduplication for Class 2 imperative singular verbs is illustrated below. First, in the data in (3), the reduplicative prefix is an open syllable, copying material in the verb stem from left to right. The prefix vowel is an identical copy for a high stem vowel and [ə] for any non-high stem vowel.⁷ Only the first vowel of a diphthong (high vowel followed by low) is copied. Tonal changes take place in the reduplicative form.⁸

(3) Class 2, Imperative non-continuous singular

	<u>Simple verb form</u>	<u>Reduplicative verb form</u>	<u>Gloss</u>
a.	rû	rû - rû	'pull'
b.	tʃî	tʃî - tʃî	'help put on head'
c.	gê	gê - gê	'belch'
d.	lô	lô - lô	'burn'

⁷ This vowel is described as 'a peripherally central close unrounded vowel much lower than, and advanced from, Cardinal Vowel [i]' (Bamgbose 1967c: 8). This vowel thus is essentially mid-high and central in character.

⁸ The tone pattern for a reduplicative form of a simple monosyllabic Class 2 verb is FF. If the simple verb is disyllabic, the reduplicative form has the tone pattern FHL for verbs ending in [o] and FFL for verbs ending in [i] (Bamgbose 1967a: 185).

e.	k̄pâ	k̄pâ - k̄pâ	'hang'
f.	fûel	fû - fûel	'blow'
g.	t̄ʃûe	t̄ʃû - t̄ʃûe	'bore (hole)'
h.	ʃîe	ʃî - ʃîe	'sell'
i.	júbô	jû - júbô	'go out'
j.	ḡbârî	ḡbâ - ḡbârî	'embrace'
k.	bórô	bâ - bórô	'help'
l.	tárô	tâ - tárô	'throw'
m.	sórô	sâ - sóró	'descend'
n.	kúelô	kû - kúelô	'nibble at'
o.	púabrî	pû - púabrî	'stray'
p.	ʃîarî	ʃî - ʃîarî	'scatter'

The data in (4) show that if the verb contains a nasal, the reduplicative prefix is formed as above but closed with a nasal stop homorganic to the following onset.

(4) Class 2, Imperative non-continuous singular

	<u>Simple verb form</u>	<u>Reduplicative verb form</u>	<u>Gloss</u>
a.	bîem	bîm - bîem	'believe'
b.	jûen	jûŋ - jûen	'learn'
c.	ḍzûoŋ	ḍzûn - ḍzûoŋ	'be higher'
d.	ḡbénô	ḡbâŋm - ḡbénò	'collide'
e.	bámô	bâm - bámò	'hide'
f.	púonî	pûm - púonî	'mix'
g.	jíonî	jîŋ - jíonî	'forget'

h.	lúonî	lún - lúonì	'repair'
i.	kpómnî	kpûŋm̄ - kpômnî	'congeal' ⁹

In imperative reduplication, the nasal agreement is unambiguously segmental copy.¹⁰ Aspects of the analysis of this reduplication phenomenon will prove to provide explanation for the similar nasal agreement phenomenon in the diminutive nominals. Accordingly, I will present an analysis of the imperative cases and then return to the diminutives.

In the analysis of Mbe reduplication, an important role will be played by rankings producing The Emergence of the Unmarked (McCarthy and Prince 1994b, 1995). The ranking schema for TETU effects in reduplication is given in (5):

(5) Faith-IO >> Phono-Constraint >> Faith-BR

Because Faith-IO dominates the Phono-Constraint (penalizing some 'marked' structure or enforcing alignment), the effect of the Phono-Constraint is not apparent in general, i.e. it will not affect correspondence between an input and output. However, with the Phono-Constraint dominating Faith-BR, it will be respected in Base-to-RED copying and can induce BR correspondence violations. This produces an 'Emergence of the Unmarked' in reduplication.

The syllable-size reduplication in imperative verbs can be obtained through a TETU ranking. Spaelti (1997) observes that this can be achieved atemptatically using an alignment constraint: ALLσL (for other applications of this constraint see Mester and Padgett 1994; Itô and Mester 1997a; Kurisu 1998; a similar approach using all-foot-

⁹ After labial-velar consonants [kp̄, k̄p̄, ḡb̄], [u] appears as the correspondent of [o] in the reduplicant.

¹⁰ Bamgbose (1971) notes that nasal agreement in imperative verbs may be treated as reduplication. It is on the basis of cases like the diminutive, which are formed with some fixed segmentism, that he proposes a non-reduplicative account.

alignment to obtain to foot-size reduplicants is employed by McCarthy and Prince 1994a; Prince 1996, 1997).

(6) ALL σ L: ALIGN(σ , L, Pwd, L)

Following the generalized interpretation of alignment constraints, ALL σ L expresses the demand that the left edge of *every* syllable be aligned with the left edge of *some* prosodic word (McCarthy and Prince 1993b). Violations are reckoned such that every misaligned syllable incurs a mark for each syllable separating it from the left edge of the Pwd. Each word containing more than one syllable will thus violate ALL σ L, and violations with every additional syllable. As a consequence, ALL σ L acts as a size-restrictor by favoring words containing only one syllable (assuming that the optimal output is fully syllabified). Spaelti's TETU ranking interleaves ALL σ L between IO and BR Faith:

(7) MAX-IO >> ALL σ L >> MAX-BR

The ranking is illustrated in (8) (tones are omitted here). Since MAX-IO dominates ALL σ L, the alignment constraint does not place a limit on root material (see (c)). However, ALL σ L outranks MAX-BR, preventing the addition of more than one syllable in reduplicative affixation (compare (a) and (b)). I assume that high-ranking constraints on syllable structure and morpheme realization rule out alternatives copying less than a syllable, such as [j-jubo] and [jubo].

(8) Syllable-size reduplicants

RED-jubo	MAX-IO	ALLσL	MAX-BR
a. ju-jubo		***	bo
b. jubo-jubo		****!***	
c. ju-ju	b!o	*	

The restriction of reduplicants to one syllable is a TETU effect, that is, it is an occurrence of unmarked structure in reduplication that does not otherwise limit forms in the language. On the other hand, the restriction of reduplicant codas to a nasal with place features linked to the following onset is a distribution holding of Mbe syllable structure in general. Bamgbose (1967c: 11) notes that across the Mbe language coda nasals must be place-linked except root-finally (i.e. word-final or before a C-initial suffix). Some examples of homorganic nasals outside of reduplication are given in (9) (with syllabic nasal prefix in c-e):

- (9) a. [n - óntòr] 'lizard'
 b. [é - kùrántsán̩] 'millet'
 c. [m̩ - bó̩r] 'palm trees'
 d. [ŋ̩ - sú̩nì] 'soldier ant'
 e. [ŋ̩ - kú̩el] 'tortoise'

From Bamgbose's data it also appears that within the domain of [prefix + root], a nasal is the only possible medial coda. Other consonants can occur in root-final position.¹¹ The condition on codas or 'CodaCond' in Mbe thus consists of three parts (i) place features of a

¹¹ Examples of word-final consonants are: [ká̩b] 'dig', [wél] 'drive away', [fí̩r] 'sneeze', [tú̩m] 'send'. Examples of root-final consonants before a C-initial suffix are: [jù̩ab - kì] 'be washing', [fù̩el - kì] 'be blowing', [tsò̩r - kì] 'be carrying', [jì̩em - kì] 'be singing'.

coda consonant must be linked to a following onset, (ii) coda consonants are limited to nasals, and (iii) the coda restrictions of (i) and (ii) are exempted in root-final position. Various aspects of similar coda conditions have been analyzed elsewhere (for analyses in an optimality-theoretic framework see, e.g., Itô and Mester 1994, in press, Alderete et al. 1996; Padgett 1995b drawing on Byrd 1992, Steriade 1993c; also Jun 1995; for a previous approach, see Itô 1986). For expository convenience, I will employ a constraint, CODACOND, which simply describes the coda condition in Mbe. This descriptive constraint is given in (10), and it refers to the combination of constraints deriving this effect. In the appendix to the analysis of Mbe (in section 6.1.9), I outline the details of the constraints and rankings that constitute the content to CODACOND.

(10) CODACOND:

Codas (except root-final) must be nasals with place linked to the following onset.

Because CODACOND is respected throughout the Mbe language, it must outrank MAX-BR and Faith-IO (I assume MAX-IO).¹² This is shown for BR faith in (11) for the imperative form of [fuel]. Here candidate (b) copies the [l] coda, but even though this fares better on MAX-BR, it loses to candidate (a) because it violates CODACOND. The alternative in (c), which loses [l] in the base in order to better satisfy MAX-BR, is ruled out on the basis of a MAX-IO violation. I assume that undominated IDENT-IO/BR[nasal] rules out alternatives changing oral consonants to nasal ones (i.e. [fun - fuel], [fun - fuen]).

¹² It is conceivable that CODACOND outranks DEP-IO rather than MAX-IO, but there are no alternating forms for which this can be tested. Thanks to Kazutaka Kurisu for raising this point.

(11) Non-nasal codas are prohibited

RED - fuel	CODACOND	MAX-IO	MAX-BR
a. fu - fuel			el
b. ful - fuel	l!		e
c. fu - fue		*!	e

Since a stem nasal can be copied but may end up changing its place specification in the reduplicant, MAX-BR must outrank the base-reduplicant place identity constraint to prevent segments from deleting rather than undergoing place assimilation. This is shown in (12) for the imperative of [jɪɔni] (restricting attention to candidates with syllable-size reduplication as in (8)). Candidate (b) loses on CODACOND because the reduplicant nasal is not place-assimilated. The alternatives are to not copy the nasal, as in (c), or copy and place-assimilate the nasal, as in (a). Even though it violates IDENT-BR[Place], candidate (a) is the winner, because it better satisfies MAX-BR.

(12) Nasal codas are place-linked

RED - jɪɔni	CODACOND	MAX-BR	IDENT-BR[Place]
a. jɪɪ-jɪɔni		ɔi	*
b. jin - jɪɔni	n!	ɔi	
c. ji - jɪɔni		ɔni!	

Before going on to explore how the CodaCond and syllable-size restriction can lend explanation to nasal agreement in diminutive formation, I will briefly examine two TETU effects concerning vowels in imperative reduplication. The first of these effects is the absence of diphthongs in the reduplicative prefix. It is widely recognized that diphthongs qualify as 'marked' structure. Rosenthal (1997) proposes the constraint in (13) to prohibit them.

- (13) NODIPH: Two tautosyllabic moras linked to distinct vowels are prohibited.

The TETU ranking which permits diphthongs in stems but not reduplicants is given in

- (14). Its effect is illustrated in (15).

- (14) MAX-IO >> NODIPH >> MAX-BR

- (15) No diphthongs in reduplication

RED-biem	MAX-IO	NODIPH	MAX-BR
a. bim̄-biem		*	e
b. biem̄-biem		**!	
c. bim̄-bim	*!		

It should be noted that since imperative reduplication skips the second member of the diphthong and copies the non-contiguous nasal, MAX-BR must outrank BASE-CONTIGUITY (McCarthy and Prince 1995: 371).¹³

The second TETU effect for vowels concerns the occurrence of [ə] in place of all non-high vowels in the reduplicant. This can be seen as an effect of the markedness of [-high] vowels in relation to [+high] ones (i.e. 'default' vowels are often [+high] in character). This markedness is encapsulated in the following ranking (see Beckman 1995 for another application of this ranking):

¹³ Note that an alternative candidate [bem - biem] ties with (15a) on contiguity (each candidate incurs one violation). Given that [bem - biem] copies the more sonorant member of the diphthong, it might actually be expected to be the winner. I suggest that copy of the first vocalic member of the diphthong can be attributed to an identity constraint for the consonantal release (IDENT_{REL-IO}, after Padgett 1995b, more detailed discussion of this kind of constraint follows in the appendix in section 6.1.9). Drawing on the insights of the aperture-theoretic representations proposed by Steriade (1993a, d. 1994), where a released stop is composed of a closure node (A₀) and a release node (A_{max}), the featural properties of the first vocalic element following the stop may be reasonably posited as affiliated with the release node of the stop. Padgett's constraint enforcing identity of features associated with a release position could then be used to ensure copying of the first member of the diphthong rather than the second.

- (16) *[-high] >> *[+high]
 (i.e. *[e], *[o] >> *[i], *[u])

While [+high] vowels are less marked than [-high] ones, the mid-central vowel [ə] also has a default character. To explain this, I will assume that [ə] is a vowel unspecified for height features. The feature [-high] thus does not occur in reduplicants. This is obtained by the TETU ranking in (17a). On the other hand, [+high] vowels do copy faithfully, motivating the ranking in (17b). The substitution of [ə] rather than [i] or [u] for [-high] vowels in reduplicants is compelled by *[+high]. Even though this markedness constraint is low-ranked, it is violated by high vowels but not by the heightless [ə].

- (17) a IDENT-IO[high] >> *[-high] >> IDENT-BR[high]
 b. IDENT-BR[high] >> *[+high]

The tableau in (18) illustrates the outcome for stems containing a [-high] vowel. Vowels in candidates considered here each come with their own height feature. Linkage of vowel height across syllables can be ruled out by a featural tautosyllabicity constraint (see Walker 1997a).

(18) No [-high] vowels in reduplication

	RED-lɔ	IDENT-IO[high]	*[-high]	IDENT-BR[high]	*[+high]
☞	a. lə-lɔ		*	*	
	b. lu-lɔ		*	*	*!
	c. lɔ-lɔ		**!		
	d. lə-lə	*!			
	e. lu-lu	*!			**

The tableau in (19) shows the faithful copying of [+high] vowels:

(19) High vowels reduplicate faithfully

	RED-ru	IDENT-IO[high]	*[-high]	IDENT-BR[high]	*[+high]
☞	a. ru-ru				**
	b. rə-ru			*!	*

Three TETU rankings have now been established for the imperative reduplication: one producing the limitation to a syllable in size, and two producing unmarked vocalic structures. These rankings are summarized in (20). (21) gives the rankings of faith and CODACOND.

(20) TETU rankings:

a. Reduplicant is a syllable:

MAX-IO >> ALLσL >> MAX-BR

b. No diphthongs in reduplicant:

MAX-IO >> NODIPH >> MAX-BR

c. [ə] for [-high] vowels in reduplication:

IDENT-IO[high] >> *[-high] >> IDENT-BR[high] >> *[+high]

(21) Faith and CODA_{COND}:

CODA_{COND} >> MAX-IO >> MAX-BR >> IDENT-BR[Place]

In the next section I explore how aspects of the analysis of the imperative reduplication can lend insight to the nasal agreement phenomenon seen in the formation of diminutive nominals.

6.1.3 Back to diminutives: Another pattern predicted by ALL_σL

The previous section presented a clear case of reduplication in imperative verbs. Interestingly, the imperative and diminutive formations have in common that a coda is only added to the prefix when a nasal can be copied from the stem, and in both cases the copied nasal must be homorganic to the following onset. We have established that the restriction of codas to place-linked nasals is explained by a general coda condition in the language. The appendix in section 6.1.9 discusses how the nasal-specific aspect of this phenomenon emerges out of phonetically-grounded factors: it is the weak perceptibility of place in nasals that makes them susceptible to place assimilation, and thereby the only possible coda consonants (drawing on Padgett 1995b). In this section I will show that in analyzing diminutive nasal agreement as reduplication, the restriction to coda copy or zero falls out from the interaction of a differentiated morpheme realization constraint and the same size-restricting constraint as that required for the imperative reduplication, ALL_σL. In fact, the diminutive will prove to be an important example of minimized copy predicted by the atemplatic TETU approach to size limiters in reduplication. I first present arguments that formation of the diminutive is complex with separate RED and fixed segment ([ke-]) morphemes, and then I show how constraints and rankings already required for Mbe contribute to obtaining the size restriction on RED.

Let us review the key points of formation of diminutive nominals. Singular diminutives are formed with a prefix [kɛ-] ([ka-] if [a] occurs in the following syllable). If there is a nasal in the noun stem, then the prefix is closed with a nasal coda homorganic to the following onset. Tonal changes also take place in diminutive formation. Some examples from (1-2) are repeated below.

- (22) a. kě - bēl 'little breast'
 b. kè - fúfú 'little sweat'
 c. kàm - bàṃ 'little bag'
 d. kě̀n - tém 'little heart'
 e. kěj - kùɔṃ 'little snake skin'
 f. kěj̄m - ḡbénó 'little upper arm'

Bamgbose (1966a: 48) notes that plural diminutive nouns are formed in the same way, but with [ke-] as the fixed portion of the prefixation.

Given that diminutive noun formation combines fixed segmentism, reduplication, and tonal patterns, it is worth considering what the internal structure of a diminutive noun is. I propose that the prefixation is complex, consisting of a prefix [kɛ-], with segmental material in the input, and a second purely reduplicative affix, RED, with no underlying segmental content. I will argue that it is RED that corresponds to the diminutive morpheme and [kɛ-] performs a separate function. In addition to RED, a morphologically-conditioned tonal pattern is required for diminutives. The complex structure is outlined in (23).

- (23) Diminutive nominals:
 kɛ + RED + *noun stem* (plus tonal information)

Importantly, I claim that diminutive prefixation does not consist of a single affix combining prespecified material ([kɛ]) and reduplication, as represented in (24).

(24) An incorrect representation:

RED + <i>noun stem</i>	(plus tonal information)
kɛ	

A prespecification analysis like that in (24) may be rejected both on the basis of cross-linguistic evidence and an argument from Mbe morphology. The cross-linguistic argument concerns overgeneration. If prespecification were permitted in reduplicants, we would expect fixed material of all kinds; however, this is not the case: fixed segments in reduplication are usually default in character and can be derived through TETU rankings (Urbanczyk 1995, 1996a, b; Alderete et al. 1996; Spaelti 1997; McCarthy and Prince 1986, 1990 provide foundation).¹⁴ If prespecification in reduplicative affixes were excluded, the limitation of fixed material to default segments would be explained.

The next point concerns nominal classes in Mbe. Recall that Mbe has seven primary nominal classes, which determine the form of number category prefixes and syntactic agreement markers. Bamgbose (1966a: 48) notes that diminutive nominals are all members of Class 4 (regardless of the nominal class for the noun root in non-diminutive form). Subject agreement prefixes in verbs and other concord markers for diminutives thus match those for Class 4. To illustrate syntactic agreement, an example of a thematic concord marker [kekue] (sg.) for a non-diminutive Class 4 noun is given in (25).

¹⁴ As noted earlier, McCarthy and Prince (1986, 1990) and Alderete et al (1996), suggest that a distinct set of cases of fixed segmentism in reduplication phenomena have a morphological basis: cf. Spaelti (1997) on 'syllable recycling'.

- (25) kè - tór kúk¹ue ñ kílé 'It was a duiker that I saw'
 sg-duiker Cl.4 theme 1 sg. saw

Interestingly, the Class 4 nominal prefixes, [kɛ-] (singular) and [ke-] (plural), precisely match the fixed segmentism in the singular and plural diminutive formation: however, non-diminutive Class 4 nouns do not exhibit nasal copy (26a). As a consequence, Class 4 non-diminutive nouns are segmentally identical to their diminutive counterparts when they do not contain a nasal, although they are generally distinguished by tonal properties (26b).

- | (26) | Class 4 (non-diminutive) | | Diminutive form |
|------|--------------------------|----------|------------------------------|
| a. | kè-tèm | *kěn-tèm | 'axe' kěn-tém 'little axe' |
| b. | kè-cì | | 'stick' kě-cí 'little stick' |

Given that diminutives are Class 4 and have prefixal material identical to the usual Class 4 prefixes, I conclude that the [kɛ-]/[ke-] portion of diminutive formation is a Class 4 prefix, not part of the diminutive morpheme itself. I suggest that the phonological constituency of the diminutive morpheme actually consists of just a tonal component and a purely reduplicative segmental component (i.e. the coda nasal). This gives a modular view of diminutive formation, as shown in (27).¹⁵

- (27) Diminutive morpheme

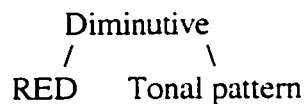

¹⁵ It is conceivable that the tone and RED elements may in fact be the phonological exponents of distinct morphemes, each making their own grammatical contribution, in which case a modular view of the diminutive morpheme would not be required. This is a matter for further study in Mbe.

The derived diminutive nominal is Class 4 and thus takes the [kɛ-]/[ke-] prefixes. This complex structure analysis explains the uniformity of Class 4 and diminutive affixes and agreement markers. If the [kɛ/ke] material were a prespecified part of a reduplicative diminutive affix, this homophony would be accidental.

With the structure of diminutive formation now established, I turn to deriving the size of the reduplicative component of the diminutive morpheme. The diminutive reduplicant is restricted to filling a syllable coda or failing to be realized at all. I suggest that the relevant generalization which underlies this pattern is that material is copied in diminutive formation only if it does not add a syllable to the word. This will be shown to be connected to the syllable-size restriction on the imperative reduplicant. In order to understand how these two size restrictions are related, we will need to call on constraints on morpheme realization. The kind of constraint which I propose to employ is given in (28) (with foundation in morpheme realization constraints from Samek-Lodovici 1992, 1993; Gnanadesikan 1996; Rose 1997; cf. also Hendricks 1998).

(28) REALIZEMORPH:

- i. A morpheme must have some phonological exponent in the output. For morphemes composed of modular components in the input, each component must have phonological exponence in the output.
- ii. A violation is incurred for each morpheme failing to have some phonological exponent in the output. For morphemes with a modular structure, a violation is accrued for each component failing to have some phonological exponence in the output.

Both the diminutive and imperative morphemes have two modular elements demanding phonological expression: a reduplicative segmental component and a tonal pattern component.¹⁶ Part (i) of REALIZEMORPH demands that both of these elements have some phonological exponence in the output. Part (ii) makes explicit how violations of the constraint are reckoned (after Zoll 1996). One violation will be incurred for each component for which there is no phonological exponent in the output, i.e. in diminutive or imperative formation, there will be one violation if copying fails, and one violation if a tonal pattern fails to be realized; if neither copy or the tone pattern appears in the output, two violations will be accrued.

In imperative reduplication, both the reduplicative and tonal components of the morpheme always have some phonological exponence in the output. In the case of the reduplicative component, this takes place at the cost of ALL σ L, since the reduplicative material adds a syllable to the word. This motivates the ranking in (29) (I assume that morpheme realization constraints may be specific to particular morphemes).

(29) REALIZEMORPH_{imp} >> ALL σ L

In contrast to the imperative, realization demands for the diminutive morpheme cannot compel the addition of a syllable. Reduplication occurs in diminutive formation only when material can be copied without adding a syllable (i.e. material is copied as a coda or not at all). ALL σ L must thus outrank the diminutive realization constraint:

(30) ALL σ L >> REALIZEMORPH_{dim}

¹⁶ If the modular analysis of these morphemes in Mbe could be eliminated (see n. 15), then the morpheme realization constraint could be simplified to eliminate reference to modularity.

Copy of a nasal along with tonal changes in the diminutive is illustrated in (31). The constraint hierarchy in this tableau combines the morpheme realization ranking in (30) with the TETU size-restriction ranking established earlier (MAX-IO >> ALL σ L >> MAX-BR). The complex constituency of the diminutive nominal is shown in the input. This consists of the Class 4 prefix [k ϵ -], the diminutive morpheme composed of RED and tonal information, and the noun stem [t ϵ m]. Only candidates obeying the Mbe CodaCond are considered here.

(31) Nasal copy and tonal changes in a diminutive nominal

	Tone k ϵ - RED - t ϵ m	MAX-IO	ALL σ L	MAX-BR	REALIZEMORPH _{dim}
a.	k ϵ n \bar{t} ϵ m		*	t ϵ	
b.	k ϵ t ϵ m		*	t ϵ m(!)	*(!RED)
c.	k ϵ t ϵ n \bar{t} ϵ m		**!*		
d.	t ϵ m	k! ϵ		t ϵ m	* (RED)
e.	k ϵ n \bar{t} t ϵ m		*	t ϵ	*!(tone)

Candidate (d) in (31) shows that the ranking of MAX-IO over ALL σ L compels retention of input segments in the output, even though this produces an output containing more than one syllable. However, as apparent from candidate (c), the ranking of ALL σ L over MAX-BR in this case prevents copied material from producing more than the two syllables required to accommodate input segments. This is one of two possible TETU size restrictions that can emerge from ALL σ L: here reduplication is restricted in size to not adding a syllable to the word. The remaining alternatives, (a), (b), and (e) tie on ALL σ L by holding to two syllables. The winning candidate in (a) partially satisfies MAX-BR by copying a nasal, and it satisfies REALIZEMORPH both through this segmental copy and realizing the necessary tonal pattern. Candidate (e) loses because it fails to realize the tone

pattern and (b) loses either on the basis of failing to copy any material (REALIZEMORPH) or an extra MAX-BR violation. It should be noted that since diminutive reduplication can copy a nasal anywhere in the stem, MAX-BR must outrank LEFT-ANCHOR-BR (McCarthy and Prince 1995: 371).

The tableau in (32) illustrates a case where reduplication fails in the diminutive. For this input, there is no nasal to copy as a coda. Since the coda condition prohibits other coda segments, this narrows the range to candidates exhibiting copy of a syllable (b) or no copy at all ((a) and (c)). The candidate copying a full syllable incurs extra violations of ALL σ L, which rules it out. The remaining alternatives each violate REALIZEMORPH with respect to the RED component of the diminutive morpheme. Candidate (c) loses to (a), because (c) also fails to realize the tonal component of the morpheme.

(32) Copy fails in diminutive; tonal changes occur

	Tone kε - RED - bɛl	MAX-IO	ALL σ L	MAX-BR	REALIZEMORPH _{dim}
a.	kɛbɛl		*	bel	*(RED)
b.	kɛbɛbɛl		**!*	l	
c.	kɛbɛl		*	bel	**!(RED, tone)

The tableau in (33) shows how the different ranking of REALIZEMORPH_{imp} causes the TETU size-restriction ranking to produce syllable-size copy in the imperative. The morpheme realization constraint in this case is undominated, forcing some segmental copy to take place along with the realization of tonal patterns (only candidates satisfying tone realization are shown). Candidate (c), which fails to copy any material, loses on a violation of REALIZEMORPH. Both candidates (a) and (b) copy segments, but (b) loses on the basis of ALL σ L, because it adds more than one syllable. The winner (a) satisfies morpheme

realization but copies just one syllable to minimally violate the alignment constraint. This gives us a second TETU size restriction from ALL σ L: copy is limited to one syllable.

(33) Syllable-size copy and tonal changes in imperative

Tone RED - jubo	MAX-IO	REALIZEMORPH _{imp}	ALL σ L	MAX-BR
a. jû-júbò			***	bo
b. jûbô-júbò			****!***	
c. jûbô		*!(RED)	*	jubo

To review, we have now seen that the same atemplatic size-restricting constraint in combination with differently-ranked morpheme realization constraints accounts for the coda/null size limitation in the diminutive and the syllable-size limitation in the imperative. The constraint hierarchy obtaining this result is given in (34).

(34) Size-restriction ranking summary

MAX-IO, REALIZEMORPH_{imp} >> ALL σ L >> MAX-BR, REALIZEMORPH_{dim}

The motivation from the analysis of reduplicative imperatives for the reduplication account of the diminutive is now two-fold. First, we have seen that the limitation to nasal copy falls out from the independent demand of CODACOND. Second, the TETU approach to the size-restriction on imperative reduplication can also explain the size-restriction seen in the diminutive. Differences in the size-restriction outcomes come from different rankings of morpheme realization constraints. The diminutive account thus strengthens the atemplatic TETU approach to size restriction in reduplication (Spaelti 1997 building on

McCarthy and Prince 1994a; Prince 1996, 1997) by providing evidence of a phenomenon predicted under the hypothesis of factorial constraint ranking.

An important aspect of the atemplatic analysis of the size restriction on diminutive copy is that it explains the coda/null size of the reduplicant. Various analysts have examined cases of reduplication where copy is limited to a single consonant. Some recent analyses in Optimality Theory of single consonant copy (in some circumstances) include Spaelti (1997) on West Tarangan and Kola; Alderete et al. (1996) on Yoruba (with a following default vowel); Gafos (1996) on Temiar, Rose (1997) on Ethio-Semitic; Takeda (1997) on Kammu; and Hendricks (1998) on Shuswap. Spaelti's (1997) analysis of 'syllable recycling' is closest to the account of Mbe developed here. I will briefly review the key points of Spaelti's account and its relation to the analysis of Mbe.

The syllable recycling phenomenon that Spaelti examines is exemplified by Rebi West Tarangan (Austronesian; spoken in the Aru Archipelago in Maluku, Indonesia). This language exhibits a reduplication pattern in which an infixing reduplicant (appearing to the left of main stress) copies a single consonant as the coda to a preceding open syllable, as in (35a). In these forms, an existing syllable is 'recycled' rather than creating a new syllable with reduplicated material. When the preceding syllable is closed, a full CVC is copied (35b).¹⁷ (Data from Spaelti 1997: 179 citing Nivens 1992, 1993.)

- (35) Rebi West Tarangan
- | | | | |
|----|-------------|---------------|--------------------|
| a. | bi'tem-na | bim'temna | 'small' (3 sg.) |
| | ta'puran | tar'puran | 'middle' |
| b. | paj'lawa-na | pajlaw'lawana | 'friendly' (3 sg.) |

¹⁷ Spaelti notes that other examples of 'syllable recycling' are listed in Broselow and McCarthy (1983).

Spaelti observes that the copy of a single segment as a coda, as in the forms in (35a), can be driven by $ALL\sigma L$ ¹⁸, i.e. minimization of the number of syllables in the word. He obtains this single consonant copy pattern by ranking $ALL\sigma L$ over a constraint requiring that the left edge of the reduplicant be aligned to the left edge of some syllable, $ALIGN(RED, L, \sigma, L)$. The tableau in (36) illustrates the analysis (from Spaelti 1997: 165). (For a full analysis of the details of reduplication in Rebi, see Spaelti 1997.)

(36) Syllable recycling in Rebi West Tarangan

	RED - tapuran	$ALL\sigma L$	$ALIGN-L(RED, \sigma)$
☞	a. tar ¹ puran	***	**
	b. tapur ¹ puran	****!***	

The analysis of nasal copy in Mbe diminutive formation draws on Spaelti's idea of using minimization of the number of syllables in the word to achieve reduplication that does not add a syllable. Importantly, Mbe and Rebi West Tarangan differ in their outcomes in words for which copy of a single consonant would be ill-formed. In Mbe diminutives this occurs when there is no nasal to copy (required by $CODACOND$), in which case reduplication fails altogether. In Rebi, single consonant copy is prevented when the preceding syllable is closed. In this circumstance, copy of a full syllable takes place (conditions on syllable structure prevent formation of a complex coda). Mbe diminutive reduplication thus violates morpheme realization rather than add a syllable to the word ($ALL\sigma L \gg REALIZEMORPH_{dim}$), but Rebi will add a syllable when necessary to achieve some segmental exponent for RED ($REALIZEMORPH \gg ALL\sigma L$). The case of CVC copy in Rebi is illustrated in (37).

¹⁸ Spaelti uses $ALL\sigma R$ rather than $ALL\sigma L$, but this is not crucial for the analytical point at issue here.

(37) CVC copy driven by morpheme realization

	RED - pajlawá - na	REALIZEMORPH	ALLOL
☞	a. pajlaw'lawana		*****
	b. paj'lawana	*!	*****

In addition to always realizing a reduplicant, Rebi West Tarangan is distinct from Mbe in always choosing the segment following the stressed vowel to copy rather than the leftmost base segment (demanded by LEFT-ANCHOR-BR: McCarthy and Prince 1995). Drawing on a proposal of Moore (1996), Spaelti (1997) notes that this can be explained by the ban on geminates in West Tarangan.¹⁹ The tableau in (38) illustrates the approach (from Spaelti 1997: 201).

(38) Copy of second consonant

	RED - tapuran	NOGEMINATE	ANCHOR-L
☞	a. tar'pura		**
	b. tap'pura	*!	

Unlike Rebi, Mbe diminutive reduplication copies the first eligible segment (a nasal) in the base, even if this produces adjacent identical nasal segments (e.g. [kèm-mù] 'little story', [kèm-mèl] 'little neck', [kě̃n-ně̃n] 'little bird', [kě̃ŋ - ŋíen] 'little thing': Bamgbose 1971: 48). Since Bamgbose notes that coda nasals are always homorganic with a following onset consonant, these nasals could reasonably be treated as geminates, in which case ANCHOR-L dominates NOGEMINATE.²⁰ However, as noted earlier (in relation to

¹⁹ See Spaelti (1997) for discussion of some remaining issues in the restriction of copy to the post-stress segment.

²⁰ It is not clear whether nasal coda-onset syllable contact occurs freely within the [prefix + syllable] domain in Mbe. No examples of a [.CVN.NV.] structure could be found in Bamgbose's data, although there is an example of a syllabic nasal prefix before a nasal onset: [ntùò éè ɲ.ɲ'uaŋ.] 'a good calabash' (Bamgbose 1966a: 47). Note that geminate consonants of other kinds are ruled out by the coda condition. If non-syllabic syllable-final nasals are generally restricted before onset nasals (outside of root-final

tableau (31)), left anchoring is violable when the only nasal occurs elsewhere in the base. ANCHOR-L must thus be dominated by either MAX-BR or REALIZEMORPH_{dim}.

To review, the ‘syllable recycling’ phenomenon in Rebi West Tarangan reduplication has in common with Mbe diminutive reduplication the copy of a single consonant to form a syllable coda, and in both languages this can be handled with the atemplatic size-restrictor constraint, ALLσL. Mbe differs from Rebi in two interesting ways. First, Mbe diminutive formation offers a new kind of resolution when single consonant copy fails: no reduplication occurs at all, violating REALIZEMORPH, in contrast to the initiation of a new syllable in Rebi. Also, Mbe copies the first eligible consonant (nasal) in the base, while Rebi always reaches rightward into the base to copy the segment following the stressed vowel. Rebi single consonant copy thus consistently violates ANCHOR-L, but Mbe violates ANCHOR-L only when the base-initial segment is not a nasal.

6.1.4 Nasal agreement in inchoative verbs

An important claim underlying the account of the diminutive is its complex formation, consisting of a componential diminutive morpheme and a separate nominal class morpheme. Nasal agreement in the formation of inchoative verbs provides further support for a complex constituency in coda/null nasal copy. The formation of inchoative verbs exhibits a nasal coda agreement in combination with fixed prefixal material, paralleling the nasal agreement of diminutive nouns. First, (39) shows that inchoative verbs are usually formed with a prefix [re-]:

position), then this occurrence in reduplication would be an ‘emergence of the marked’, a phenomenon discussed in n. 31.

(39)	<u>Simple verb form</u>	<u>Gloss</u>	<u>Inchoative verb form</u>	<u>Gloss</u>
	tà	‘touch’	rê-tà	‘has started to touch’
	kél	‘look’	rê-kél	‘has started to look’
	káb	‘dig’	rê-káb	‘has started to dig’

In (40) we see that if the verb contains a nasal, it is copied as a coda to the [re-] prefix (note that [e] reduces to [ə] in a closed syllable).

(40)	<u>Simple verb form</u>	<u>Gloss</u>	<u>Inchoative verb form</u>	<u>Gloss</u>
	túom	‘send’	rân-túom	‘has started to send’
	kèn	‘walk’	râŋ-kén	‘has started to walk’
	jíonî	‘forget’	râŋ-jíonî	‘has started to forget’

Given the arguments against prespecification in reduplicative affixes and the complex structure proposed for diminutive formation, it is reasonable to posit a complex structure for inchoative verb formation as well:

- (41) Inchoative verbs:
 re + RED + *verb stem* (plus tonal information)

As in the case of diminutives, there is evidence from the morphology of Mbe, supporting the analysis of the fixed segmentism in inchoative formation as a separate prefix. The evidence comes from the fact that [re-] occurs in the formation of four other verbal tense/aspect forms, either as the sole prefixal material or in combination with [ke] (it is conceivable that [reke-] may have a complex structure [re + ke]). This is shown in (42). Note that different tonal patterns also accompany different tense/aspect forms.

(42)	a.	<u>Remote Past (sg.)</u>	<u>Gloss</u>
		rè-tá	‘had touched’
		rè-jíem	‘had sung’
	b.	<u>Past Continuous (sg.)</u>	<u>Gloss</u>
		rèké-ta	‘was touching’ ²¹
		rèké-jìemó	‘was singing’
	c.	<u>Future (sg.)</u>	<u>Gloss</u>
		rèké-tà	‘will touch’
		rèké-jíem	‘will sing’
	d.	<u>Future Continuous (sg.)</u>	<u>Gloss</u>
		rèké-tá	‘will be touching’
		rèké-jíemó	‘will be singing’

Since the [re] segmentism occurs in the formation of a variety of verbal tense/aspect forms, I hypothesize that it is not segmental material specific to the inchoative morpheme, but rather it has some more general function across these verbal forms (although the precise nature of the function and meaning of [re-] requires further research). This leaves an inchoative morpheme consisting of just RED and tonal information, matching the structure proposed in (41) above.²²

Reduplication in inchoative formation takes place only when material can be copied without adding a syllable. As established in the analysis of diminutives, this pattern is

²¹ For this form, the tone on [ta] is not marked in the source (Bamgbose 1967b).

²² Again, further investigation of the morphology of the language may show that RED and the tonal information may be better analyzed as exponents of distinct morphemes.

obtained when the size-restricting constraint, $ALL\sigma L$, outranks morpheme-realization. This motivates the following ranking:

(43) $ALL\sigma L \gg REALIZEMORPH_{Inc}$

The inchoative data thus strengthens the reduplication analysis of nasal agreement by presenting independent support for a separate prefix with fixed material to which a nasal reduplicative affix may form a coda. Further, it provides an additional case of affixation in Mbe which falls under the ranking structure proposed for the diminutive.

6.1.5 Independent evidence for $REALIZEMORPH$: Zoque

Violable morpheme realization constraints play an important role in achieving coda/null copy in diminutive and inchoative nasal agreement. In this section I show that prefixation in Zoque (Zoquean; Southern Mexico) provides cross-linguistic support for a violable $REALIZEMORPH$ constraint.

In Zoque, morpheme realization fails when a nasal pronominal prefix fails to undergo place assimilation to a following consonant. Data and description are from Wonderly (1951), and for previous analyses see Dell (1973), Lombardi (1990), Steriade (1993a), and Padgett (1994, 1995c). The data are given in (44-45). The data in (44) show that a nasal pronominal prefix assimilates in place to a following oral stop or affricate. It may be noted that post-nasal voicing in these data is an independent phenomenon taking place in non-homorganic sequences as well.

(44)	a.	N - pama	→	mbama	'my clothing'
	b.	N - plato	→	mblato	'my plate'
	c.	N - tatah	→	ndatah	'my father'

d.	N - trampa	→	ndrampa	'my trap'
e.	N - tsima	→	ndzima	'my calabash'
f.	N - tʃoʔngoja	→	ɲdʒoʔngoja	'my rabbit'
g.	N - kaju	→	ɲgaju	'my horse'
h.	N - gaju	→	ɲgaju	'my rooster'
i.	N - kwarto	→	ɲgwarto	'my room'

The data in (45) show that the nasal prefix fails to surface before a continuant consonant ([l] is assumed here to be [+continuant] after Padgett 1994: 485, 1995c: 41).²³

(45)	a.	N - faha	→	faha	'my belt'
	b.	N - sik	→	sik	'my beans'
	c.	N - ʃapun	→	ʃapun	'my soap'
	d.	N - rantʃo	→	rantʃo	'my ranch'
	e.	N - lawus	→	lawus	'my nail'

It is reasonable to posit that the nasal prefix deletes before a continuant consonant because place assimilation has failed to take place (see, for example, Padgett 1994, 1995c). Note, however, that while non-homorganic nasals are forbidden before a consonant word-initially, they can occur in word-medial position:

(46)	a.	t̄sam̄tsam̄naju	'he chatted'
	b.	n̄im̄geʔtu	'he also said'
	c.	m̄in̄ba	'he comes'

²³ The nasal prefix also deletes before [ʔ, m, n, ɲ]. It is retained before [w, j, h] (Wonderly 1951: 121). See Padgett (1995c: 64-5) for analysis of the latter cases as place assimilation with gliding.

- d. keŋgeʔtu ‘he also looked’
 e. ʃuhpuŋbuŋ ‘soapberry’
 f. maŋba ‘he goes’
 g. tsiŋdami ‘bathe!’

Padgett (1994, 1995c) develops an insightful generative account of the nasal pronominal prefixation, which I will essentially follow here translated into an OT framework. My concern will be with where a morpheme realization constraint figures in the ranking. Padgett observes that nasals only undergo place assimilation to segments of like stricture. To obtain this, he proposes that place-assimilated nasals in Zoque must also share stricture features with the following consonant. The details of how this structure is to be enforced need not concern us here, for further details the reader may consult Padgett’s analysis. For the present purposes, I will simply use the descriptively-expressed constraint in (47), which refers to the combination of constraints deriving this effect. Note that Mbe does not exhibit this restriction on place-linked nasals.

- (47) *NZ: No place-linking between nasals and continuants.

Padgett observes that the difference in acceptability of word-initial versus word-medial non-homorganic nasals can be attributed to a distinction in the syllabification of NC clusters in these environments. In initial NC clusters he proposes that the nasal is syllabified along with the following consonant into an onset, while in medial NC clusters, the nasal belongs to a coda. Drawing on this distinction, he suggests that the prohibition on non-homorganic nasals in word-initial position is the result of a more general syllable

structure restriction in Zoque whereby onsets license only one consonantal place feature. This restriction I will refer to with the descriptively-expressed constraint in (48):

(48) I-C-PLACE: Onsets license only one C-Place feature.

Both the constraints $*\widehat{NZ}$ and I-C-PLACE are undominated in Zoque. When they cannot be satisfied in a nasal + continuant consonant cluster, they compel a violation of REALIZEMORPH, that is, the nasal pronominal prefix fails to have a phonological exponent in the output. This is illustrated in (49). A hypothetical coronal nasal prefix input is shown here. [.] marks syllable boundaries.

(49) Nasal prefix loss before a continuant

n - faha	$*\widehat{NZ}$	I-C-PLACE	REALIZEMORPH
a. .fa.ha.			*
b. .nfa.ha.		*!	
c. . \widehat{m} fa.ha.	*!		

In the case of nasal + noncontinuant-obstruent initial clusters, the nasal prefix will undergo place assimilation at the cost of any input place specification in order to satisfy REALIZEMORPH. REALIZEMORPH must thus outrank IDENT-IO[Place]. Given richness of the base (Prince and Smolensky 1993: 191), this ranking is needed to derive the correct outcome no matter what the input place of the pronominal prefix.

(50) Nasal prefix place assimilation to following stop

	*N̄Z	l-C-PLACE	REALIZEMORPH	IDENT-IO[Place]
n - gaju				
☞ a. .ŋga.ju.				*
b. .nga.ju.		*!		
c. .ga.ju.			*!	

Finally, because medial NC clusters syllabify the nasal into a coda, l-C-PLACE will not come into play in these structures, and nasal place identity will be respected:

(51) No nasal place assimilation word-medially

	*N̄Z	l-C-PLACE	REALIZEMORPH	IDENT-IO[Place]
manba				
☞ a. .maŋ.ba.				
b. .mam.ba.				*!

The constraint hierarchy established for Zoque nasal place assimilation and prefixation is summarized in (52):

(52) *N̄Z, l-C-PLACE >> REALIZEMORPH >> IDENT-IO[Place]

The significance of this hierarchy for the analysis of Mbe nasal agreement is that it offers independent evidence from another language for a violable REALIZEMORPH constraint. In addition, the Zoque pronominal prefix parallels the diminutive and inchoative formation in permitting the occurrence of a prefixal nasal segment only when place-linked to a following consonant. In Mbe, this is resolved by nasal place assimilation to any following consonant; in Zoque, nasal place assimilation occurs only when the following consonant is similar in stricture; i.e. a noncontinuant.

6.1.6 Extending explanation to other affixation

In the analysis of nasal copy across the imperative and inchoative verbs and diminutive nouns, an important role is played by the atemptatic size-restricting constraint, ALL σ L. Another affixation phenomenon in Mbe also exhibits a restriction which may be attributed to the force of this constraint. In this section, I will briefly outline how ALL σ L applies to a size-restriction on class prefixation in nominal morphology.

We have already seen that nouns take nominal class prefixes marking number category (e.g. (1-2)). The examples given so far show a prefix applied to a noun root in non-diminutive nominals or a prefix ([ke-/ke-]) applied to a derived diminutive nominal. However, in some cases class prefix affixation is more complex. To understand this, we must first consider the three forms of nominal prefixes. These are (i) CV or V, which occur before consonant-initial stems, (ii) C, which occurs before a vowel-initial stem, and (iii) N, which occurs before vowel-initial or consonant-initial stems. Bamgbose (1966a: 36) notes that plural prefixation exhibits what I will call a ‘cumulative affixation’ property such that when the singular form of a noun is formed with one of the latter two types of prefix (C or N), then the plural nominal class prefix is added to the whole of the singular noun form. Yet if the singular is formed with a CV or V prefix, the plural prefix replaces the singular prefix in the plural noun. This is illustrated in (53); examples (a-d) show cumulative affixation and (e-h) show replacement.

(53)	<u>Singular</u>	<u>Plural</u>	<u>Gloss</u>
a.	l - én	bè - lén	‘name’
b.	l - úob	bè - lúob	‘navel’
c.	m - òm	bè - mòm	‘wine’
d.	m - pîe	bè - mpîe	‘dog’
e.	kè - tór	kè - tór	‘duiker’

f.	ò - sùe	è - sùe	'house'
g.	lè - lé̄m	bè - lé̄m	'tongue'
h.	lè - kwór	ḡ - kwór	'heap'

A similar cumulative affixation effect appears in diminutive formation. Nouns which take C or N prefixes in their non-diminutive form construct their diminutive counterpart by prefixing [kɛ-] and [ke-] to singular and plural non-diminutive noun forms respectively (54a-b). Nouns with a V or CV prefix in their non-diminutive form replace this with [kɛ-/ke-] in their diminutive counterpart (54c-d).

(54)	<u>Non-diminutive</u>	<u>Diminutive</u>	<u>Gloss</u>
a.	l - í	kɛ̄ - lí	'eye'
b.	ḡ - kúel	kɛ̄ḡ - kúel	'tortoise'
c.	bù - tsí	kɛ̄ - tsí	'chair'
d.	ò - bé	kɛ̄ - bê	'hand'

Why are purely consonantal prefixes retained but V or CV ones replaced? A phonological generalization underlies this phenomenon: cumulative prefixation takes place only when the combined prefixal material amounts to no more than a syllable. This is particularly clear when we consider the variable syllabification of nasal prefixes. In word-initial position before a consonant, nasal prefixes are syllabic and tone-bearing; however, when an additional V or CV prefix appears before them, nasal prefixes are syllabified into a syllable coda and do not bear a tone. The restriction of nominal prefix material to no more than a syllable can be explained by a familiar constraint in our analysis of Mbe: ALLσL. Here the size-restrictor constraint limits the total size of combined prefixes (whether

reduplicative or non-reduplicative). The analysis involves calling on a separation between faith for root material and faith for affix material. This segregation has basis in a wide range of cross-linguistic phenomena showing asymmetries in root versus affix faith (see, for example, McCarthy and Prince 1994a, 1995; Beckman 1995, 1997, 1998; Selkirk 1995; Urbanczyk 1996b; Alderete 1996, 1997a, Walker 1997b). McCarthy and Prince (1994a, 1995) propose a universally fixed ranking for root and affix faith, given in (55):

- (55) Root-Affix faithfulness metaconstraint:
 Root-Faith >> Affix-Faith

In the case of nominal prefixation, ALL σ L limites the total size of combined prefixation to one syllable. Root material is not limited, however. This is achieved by an affixal TETU ranking, as in (56):

- (56) Root-Faith >> ALL σ L >> Nominal-Affix-Faith

The ranking in (56) refers to nominal affixation in particular, because verbal affixation proves to be capable of adding more than one syllable (as we will see in section 6.1.9).²⁴ The way in which the ranking in (56) realizes the size-restriction on cumulative nominal prefixation is shown in (57-58). Here I posit inputs containing multiple nominal prefixes in forms with potentially complex prefixation. I assume that a high-ranking constraint enforcing the presence of some nominal class prefix rules out candidates with no prefixation at all.

²⁴ In another kind of lexical category faith distinction, Smith (1997) argues for the existence of faithfulness constraints that are specific to nouns (to explain Japanese accent patterns). In Mbe, affixes on verbs must have a higher-ranked faith demand than those for nominal affixes (or perhaps just affixes in the general case).

(57) Cumulative prefixation occurs when combined material does not exceed a syllable

	Root-Faith	ALL σ L	Nom-Affix-Faith
b ϵ - N - pie			
a. .b ϵ m.pie.		*	
b. .b ϵ .m.pie.		**!*	
c. .b ϵ .pie.		*	m!
d. .m.pie.		*	b!e
e. .b ϵ m.	p!ie		

(58) No cumulative prefixation when combined material would exceed a syllable

	Root-Faith	ALL σ L	Nom-Affix-Faith
N - le - kwor			
a. .ŋ.kwor.		*	le
b. .n.le.kwor.		**!*	

LINEARITY-IO, which enforces the same ordering relations between material in the input and material in the output, rules out the alternative [leŋkwor] (McCarthy and Prince 1995: 371); alternatively, this could be ruled out by morphological demands on the ordering of morphemes. The preservation of the leftmost prefix over others may be attributed to a high-ranking demand to express the plural morpheme in plural nominals. This will rule out [lekwor] as the optimal output for the form in (58) (this form also violates a left-anchoring constraint).

This analysis focuses only on the implications of complex prefixation for the role of the size-restricting constraint in Mbe grammar. A separate and interesting issue that will not be examined here is why cumulative prefixation takes place. It is conceivable that this phenomenon is a paradigm uniformity effect (see, e.g., Benua 1995, 1997; McCarthy 1995; Kenstowicz 1995; Burzio 1997), or it is possible that it is motivated by some

function of nominal class prefixes beyond simply marking number category. These are morphological issues that definitely deserve further investigation.

6.1.7 Atemplatic versus templatic approaches to size restriction

In the analysis of prefixation in Mbe presented above, the size-restrictor constraint ALL σ L explains a number of effects, including the syllable-size copy of the imperative, the coda/null copy of the diminutive and inchoative, and the limit of a syllable on combined nominal prefixation. Previous approaches to size-restrictions in reduplication have called on templates to limit copied material. In this section, I will compare this alternative to the atemplatic TETU account. Interestingly, templates prove to be insufficient for handling the range of size restrictions in Mbe.

One version of the template-based approach to size-restriction makes use of fixed reduplication-specific templatic constraints. Under the Prosodic Morphology Hypothesis, these templates are prosodically-defined (e.g. RED= σ ; McCarthy and Prince 1986, 1990, 1993a). This approach signalled a breakthrough in the understanding of reduplication, and it accounts for the majority of reduplication phenomena, for example, in Mbe, RED= σ , can handle the imperative syllable-size copy.²⁵ However, the more unusual size restriction exhibited by the diminutive and inchoative reduplicants in Mbe poses a problem for prosodically-defined templates. One problem is that the coda/null size of the reduplicant does not correspond to a unit of prosody; another drawback is that a fixed templatic form does not predict the variability of the reduplicant realization as coda segment or zero. In addition, since nominal prefixation does not restrict the size of a particular prefix but rather limits the combined size of overall prefixation, even apart from reduplication, the fixed templatic approach does not serve to explain the cumulative prefixal size restriction.

²⁵ For arguments against an earlier templatic theory calling on fixed CV skeleton structure (e.g. McCarthy 1981; Marantz 1982), see McCarthy and Prince (1986, 1990).

A second templatic alternative building on the insights of the Prosodic Morphology Hypothesis is known as ‘Generalized Template Theory’ (McCarthy and Prince 1994a, b; Urbanczyk 1995, 1996a, b). This approach achieves size restrictions through TETU rankings with templatic constraints on the phonological structure of a general morphological category, such as ‘Affix’. An example of a generalized templatic constraint is $Afx \leq \sigma$: ‘the phonological exponent of an affix is no larger than a syllable’. $Afx \leq \sigma$ easily handles the case of imperative syllable-size copy. Ranking this constraint between MAX-IO and MAX-BR will limit reduplicant size to one syllable. MAX-BR will drive copy of the largest possible syllable, and the independently-required CODACOND will restrict coda material to that allowed in the language. This is shown in (59).

(59) $Afx \leq \sigma$ in syllable-size copy

RED - jubo	CODACOND	MAX-IO	$Afx \leq \sigma$	MAX-BR
a. ju - jubo				bo
b. jubo - jubo			*!	
c. jub - jubo	*!			o
d. ju - ju		b!o		

Although generalized templates account for the majority of reduplication phenomena, they are insufficient for the more unusual cases of diminutive/inchoative coda/null reduplication. The problem is that the templatic size restrictor is specific to the size of the affix and does not make reference to the overall syllabic structure of the word. Ranked between IO and BR faith, $Afx \leq \sigma$ predicts that copied material will form a full syllable, driven by the maximizing function of MAX-BR, as shown in (60). This incorrect outcome is signalled by the reverse-pointing hand beside candidate (c). Candidate (a), which is the actual outcome, is not selected by this tableau.

(60) $Afx \leq \sigma$ gives wrong outcome for diminutive

	ke - RED - tem	CODACOND	MAX-IO	$Afx \leq \sigma$	MAX-BR
☞	a. $k\bar{e}n\text{-}tem$				t!ε
	b. ke - tem				t!εm
☞	c. $k\bar{e}t\bar{e}n\text{-}tem$				

The fact that reduplication for the diminutive and inchoative morphemes takes place only when it will not add a syllable to the word requires independent explanation. $ALL\sigma L$ is what achieves this explanation; yet it is also capable of capturing the size-restriction on its own. It thus obviates the need for a generalized templatic constraint. A similar problem arises with the syllable-size limit on cumulative nominal prefixation. Here it is not the case that individual prefixes must be less than a syllable in size, rather they must together add no more than a syllable to the word. This requires invoking $ALL\sigma L$ to limit size over the word, and this constraint on its own can perform the work of a generalized templatic constraint. The atemplatic approach to syllable-size restriction (Spaelti 1997) can be understood as a progression of the Prosodic Morphology Hypothesis and Generalized Template Theory. It retains the insights that size restrictions in reduplication are correlated to prosodic structure and may be derived with TETU rankings. Where it advances is in eliminating the need for templates. The morphology of Mbe provides empirical evidence that this is a necessary step to take.

Finally, there is an argument concerning theoretical overgeneration against the use of templatic constraints. This argument, discussed by Prince (1996, 1997) and Spaelti (1997), is known as the Philip Hamilton/René Kager Conundrum. The analysts for whom the conundrum is named observed that the use of templatic constraints in Optimality Theory predicts the occurrence of back-copying of templatic conditions, e.g., a requirement of a

syllable-size reduplicant may induce truncation of the base to a syllable in size in order to perfectly satisfy BR faith; however, back-copying of templatic conditions is unattested. Prince and Spaelti point out that using atemplatic alignment constraints to produce size restrictions is not faced with this problem.

We have seen that templatic alternatives to size restriction are insufficient to obtain reduplicant size limits and are also not required. In addition, they are not capable of providing explanation for the range of size-restriction phenomena that ALL σ L covers. I conclude that TETU rankings with atemplatic alignment constraints, which minimize structure over the entire word, are not only successful size-restrictors, but they are necessary. The argument of overgeneration provides a theoretical motivation. Mbe adds to the set of languages providing an empirical justification: it exhibits size restrictions (with some novel characteristics) which necessitate an atemplatic approach.

6.1.8 Ruling out prespecification in reduplication

I conclude the discussion of Mbe by returning to the issue of prespecification in reduplication. The formation of diminutives and inchoatives, in which a reduplicated nasal forms the coda to fixed segmental prefix material, may at first seem to suggest a need for prespecified segments in reduplicative affixes. However, I have presented evidence from other aspects of Mbe morphology showing that the fixed segmentism is best analyzed as material belonging to a separate morpheme from RED. It was also noted that previous analysts have argued that prespecified material in reduplicants should be generally disallowed, since the theory would otherwise predict a wider range of fixed segmentism than is actually attested (McCarthy and Prince 1986; Urbanczyk 1996a, b; Alderete et al. 1996).

On the basis of these arguments, it seems desirable to rule out the occurrence of prespecified segments in reduplicants. I propose to obtain this result on the basis of constraint rankings holding over the set of output candidates. The alternative would be to try to rule out prespecification in reduplicants in the input. Note that this could not be achieved with optimality-theoretic constraints, since these apply to outputs not inputs. Given the assumption of Richness of the Base, which posits that all inputs are possible (Prince and Smolensky 1993: 191), the null hypothesis would be that prespecification in reduplicants could occur in inputs. Ignoring this possibility amounts to simply stipulating that reduplicative affixes cannot come with segmental material in the input, something that runs counter to the basis of Optimality Theory. Allowing for the possibility of prespecified reduplicative affixes in the input, I suggest that the absence of prespecification as the source of fixed segmentism in reduplicants in the output can be derived from an extension of the Root-Faith >> Affix-Faith metaconstraint (McCarthy and Prince 1994a, 1995).

I begin by reviewing the correspondence relations that hold in reduplication. The ‘Basic Model’ of McCarthy and Prince (1995: 273) is given in (61) (the ‘Full Model’ includes Stem-to-RED identity or IR-Faith, but this will not concern us here).

(61) The Basic Model of reduplicative identity:

Input:	/Af _{RED} + Stem/
	↑↓ <i>I-B Faithfulness</i>
Output:	R ↔ B
	<i>B-R Identity</i>

The model in (61) posits a correspondence relation between (i) the input and output forms of the stem, and (ii) between the output form of the stem (the base) and the output form of the reduplicative affix. In this model, the reduplicative affix is in correspondence only with the base. If it were assumed that the reduplicative affix came with no prespecified material,

there would be nothing in the input form of the affix to which the output could correspond. However, let us suppose that the reduplicative affix can have prespecified segmentism. This necessitates an elaborated version of the 'Basic Model' with correspondence between the input and output forms of the affix, as shown in (62)

(62) Elaborated Basic Model of reduplicative identity:

Input:	/AfRED + Stem/
	$\begin{array}{cc} \uparrow\downarrow & \uparrow\downarrow \\ \text{Affix-IO Faithfulness} & \text{Stem-IO Faithfulness} \end{array}$
Output:	R ↔ B
	<i>B-R Identity</i>

In the case of reduplicative affixes, Affix-IO faithfulness has the potential to conflict with BR Identity. Constraint ranking gives the two possible outcomes in (63). Faith is subscripted here to indicate that these rankings generalize over any combination of faith constraints (i.e. any combination of MAX, DEP, etc.).

- (63) a. Faith_i-BR >> Affix-Faith_j-IO
 b. Affix-Faith_i-IO >> Faith_j-BR

The ranking in (63a), which places BR-Faith over Affix-Faith, yields a pattern in which maximal reduplication takes place (within the limits of any size-restriction) and wins over prespecified material. This outcome corresponds to the one in which there is no apparent prespecification, a result which is clearly well-attested. The second ranking, in (63b), places Affix-Faith at the top. With this hierarchy for MAX, any prespecified material will appear in the output at the cost of maximizing copied material from the base. This is illustrated in (64) for a hypothetical language with a RED containing prespecified segmentism [so]. Here the prespecified material is preserved and reduplication takes place

to fill up the remainder of the size restriction. This outcome is the one which may yield prespecified material as the source of fixed segmentism in reduplication, a pattern we have seen reason to believe is unattested.

(64) A ranking yielding combination of prespecified material with reduplication

	RED - bam so	AFFIX-MAX-IO	ALLσL	MAX-BR
☞	a. sob - bam		*	am
	b. bam - bam	*!	*	

Another problematic kind of fixed segmentism arises under a combination of DEP and MAX constraints. The tableau in (65) shows how this can produce full copy of the base in combination with fixed material. What is unexpected about this kind of outcome is that the fixed [so] occurs only with reduplicative forms, not otherwise.

(65) Prespecified material plus full copy

	RED - bam so	AFFIX-MAX-IO	DEP-BR
☞	a. sobam - bam		so
	b. bam - bam	*!	

Note that Faith-BR and Affix-Faith-IO only have the potential to conflict when correspondence holds for a given affix to both input material and base material. i.e. when a reduplicative affix comes with prespecified content. If the ranking in (63b) could be eliminated, we would prevent prespecified material from ever appearing in the output of a reduplicative affix at the cost of reduplicative faith. I suggest that this result can be achieved by extending McCarthy and Prince's Root-Affix Faith metaconstraint, a ranking-

restrictor with significant independent motivation in the theory. Let us consider the correspondence relations in (63) in terms of root and affix faith. Affix-Faith-IO is an affix-to-affix correspondence relation, and Faith-BR is a correspondence relation between a root or root-containing stem and an affix. The undesirable ranking in (63b) thus ranks a faith relation between affixes over a faith relation between a root-based form and an affix. I propose to revise the metaconstraint: Root-Faith >> Affix-Faith such that any correspondence relation in which the first argument is a *root* or root-containing stem universally outranks a correspondence relation where the first argument is an *affix*. The first argument is the one that is relevant, since the root-based constituent always forms the first argument in any root-to-affix correspondence relation (i.e. Faith-BR, following McCarthy and Prince 1995). The revised metaconstraint is given in (66):

(66) Revised Root-Affix Faith metaconstraint:

Faith_i-Root-*X* >> Faith_j-Affix-*Y*

The metaconstraint in (66) admits the rankings Root-Faith_i-IO >> Affix-Faith_j-IO and Faith_i-BR >> Affix-Faith_j-IO and rules out their reverse counterparts *Affix-Faith_i-IO >> Root-Faith_j-IO and *Affix-Faith_i-IO >> Faith_j-BR. We may thus eliminate the ranking in (63b), and consequently the emergence of prespecified material in a reduplicative affix, on the basis of the more general principle of Root over Affix Faith.²⁶

6.1.9 Appendix: Deriving CodaCond in Mbe

In section 6.1.2 I made use of a descriptive constraint, CODACOND, noting that the effect of this constraint could be derived through the interaction of other more basic constraints.

²⁶ Under an alternative view of reduplication in the Reduplicate! model of Spaelti (1997), the problem of prespecification could be obviated by the model itself, since there is no empty affix posited at all. This may provide an argument for re-examining the standard assumptions about the nature of RED.

In this appendix, I examine the details of these rankings, drawing on the work of previous analysts of cond condition effects. The descriptive properties of the coda condition in Mbe are repeated in (67):

- (67) Coda condition in Mbe
- (i) Place features of a coda consonant must be linked to a following onset.
 - (ii) Coda consonants are limited to nasals.
 - (iii) The coda restrictions of (i) and (ii) are exempted in root-final position.

First, place features of a coda consonant must be linked to a following onset. Alderete et al. (1996) suggest that this may be driven by the interaction of markedness and faith constraints.²⁷ The constraints driving multiple linking are place feature markedness constraints, which I refer to here as *C-PLACE/X (collapsing the hierarchy *PL/DORS, *PL/LAB >> *PL/COR; after Prince and Smolensky 1993; Smolensky 1993; for applications see Padgett 1995a; Alderete et al. 1996; among others). Importantly, violations of *C-PL/X are reckoned on an autosegmental basis rather than a segmental one, so that one occurrence of a place feature linked to two segments incurs one violation for the single place feature, rather than two violations for the two segments to which it is linked (McCarthy and Prince 1994a; Itô and Mester 1994; Beckman 1995, 1997, 1998; Alderete et al. 1996; Walker 1998). This is illustrated in (68).

- (68) a. One *C-PL/X violation b. Two *C-PL/X violations
- | | |
|---|---|
| $\begin{array}{cc} C & C \\ \backslash & / \\ [+coronal] \end{array}$ | $\begin{array}{cc} C & C \\ & \\ [+cor] & [+cor] \end{array}$ |
|---|---|

²⁷ Cf. Padgett (1995b), who uses spreading constraints rather than markedness; cf. also Itô and Mester (1994, in press) on an approach to coda place-linking using alignment.

If *C-PL/X outranks consonantal place feature identity constraints (both IO and BR), then place-linked structures for consonant clusters in roots and reduplicants will be selected over structures with two separate places. MAX constraints must also outrank place-identity constraints to prevent segments from deleting rather than undergoing place assimilation. This is shown in (69), restricting attention to candidates preserving onset place features. High-ranked ONSET is shown to prevent deletion of onset consonants. This tableau also includes an undominated constraint, HAVEPLACE, which requires that every consonant have some place feature specification (Itô and Mester 1993; Lombardi 1995b; Padgett 1995b). [T] represents a placeless consonant.

(69) Copied codas are place-linked

	RED-jiõni	HAVEPLACE	ONSET	*C-PL/X	MAX-IO MAX-BR	IDENT-IO[Place] IDENT-BR[Place]
Ⓜ	a. j̃iŋ-j̃iõni			j, ŋ, n		*(BR)
	b. jin-jiõni			j, n, j, n!		
	c. ji-jiõni			j, j, n	n!(BR)	
	d. ji-jiõi		*!	j, j	n(IO)	
	e. jiT-jiõni	*!		j̃, j̃, n		*(BR)
	d. TiT-TiTõi	*!***				** (IO)

A second property of the place assimilation must yet be explained: coda place features take on the place features of a neighboring onset but not the reverse. In his discussion of nasal place assimilation, Padgett (1995b) handles this by calling on faith constraints that are position sensitive, where the availability of such positions is defined by greater perceptual facilitation or prosodic privilege (Beckman 1995, 1997, 1998; McCarthy 1995; Lombardi 1995b; Alderete 1995, 1996; Selkirk 1994 cited by Beckman 1998:

Katayama 1998; Walker 1998). Padgett observes that the positional asymmetry for place assimilation has a phonetic grounding: consonants are more likely to resist loss of input place features in positions where they are released, that is, in positions where they occur before a tautosyllabic liquid or vocoid (1995b: 17-18, drawing on Byrd 1992; Steriade 1993c; see also Jun 1995).²⁸ Faith constraints specific to the perceptually-salient position of release are capable of preventing *C-PL/X from threatening the preservation of place features in onset position. The positional faith constraint that will be required is given in (70) (after Padgett 1995b: 19):

(70) IDENT_{REL}-IO[Place]:

Let S be a [+release] segment in the output. Then every place feature in the input correspondent of S has an output correspondent in S.

The ranking needed for Mbe places release-sensitive IO-faith for place features over *C-PL/X, which in turn outranks general faith for place features:

(71) IDENT_{REL}-IO[Place] >> *C-PL/X >> IDENT-IO/BR[Place]

This ranking will produce spreading of place features from onsets to codas in consonant clusters, as illustrated in (72). Only candidates respecting HAVEPLACE and ONSET are considered here and in subsequent tableau.

²⁸ Padgett observes that positions of release may be expanded in some languages to include word-final consonants; also in some languages positions of release may include consonants in all positions (1995b: 18).

(72) Place features spread from onset to coda

	RED-puɔni	IDENT _{REL} -IO[Place]	*C-PL/X	IDENT-IO[Place] IDENT-BR[Place]
☞	a. pu ^m -puɔni		p, m ^p , n	*(BR)
	b. pu ⁿ -tuɔni	*!	p, nt, n	*(IO)
	c. pu ⁿ -puɔni		p. n. p. n!	

IDENT_{REL}-BR[Place] must also outrank *C-PL/X to ensure identity of place feature copy. Recall that *C-PL/X collapses a hierarchy of place feature markedness constraints. It is the dominating status of BR and IO IDENT_{REL}-[Place] that prevents place features in released positions from reverting to the least marked consonantal place (e.g. coronal, or in some languages laryngeal). The definition of IDENT_{REL}-BR[Place] is given in (73) and the tableau showing its application is in (74) (considering only candidates respecting the non-high vowel reduction in the reduplicant).

(73) IDENT_{REL}-BR[Place]:

Let S be a [+release] segment in the reduplicant. Then every place feature in the base correspondent of S has a reduplicant correspondent in S.

(74) Onset place identity is preserved

	RED-ge	ID _{REL} -IO[Place] ID _{REL} -BR[Place]	*PL/DOR *PL/LAB	*PL/COR	ID-IO[Place] ID-BR[Place]
☞	a. gə - ge		**		
	b. də - ge	*!(BR)	*	*	*(BR)
	c. də - de	*!(IO)		**	*(IO)

Next we must explain why coda consonants are limited to nasals (except in root-final position, which I will return to presently). In dealing with the failure of coda

obstruents to assimilate in place, Padgett (1995b: 23) suggests a breakdown for place-faithfulness by segment type in which faith for place features in obstruents outranks faith for place features in nasals, a ranking grounded in the observation that nasal place is more difficult to perceive than obstruent place (see Ohala and Ohala 1993: 241-2 and references therein). To this I propose to add that identity for place in approximants also outranks nasal place identity:

(75) IDENT-IO/BR[OBS-Place], IDENT-IO/BR[APR-Place] >> IDENT-IO/BR[NAS-Place]

If faith for place features occurring in obstruents and approximants are high-ranked in Mbe, then obstruents and approximants will always retain their place specifications. These leaves two possible outcomes for these classes of segments in codas ([-release] positions), they will either occur in codas with distinct place features (violating *C-PL/X) or they will be disallowed in codas (I assume violating MAX rather than DEP, see n. 12). The latter is what takes place in Mbe (except root-final), meaning that C-PL/X must outrank MAX-IO/BR, as shown in (76). As noted in section 6.1.2, I assume that undominated IDENT-IO/BR[nasal] rules out alternatives changing oral consonants to nasal (i.e. [fun-fuel, [fun-fuen]), and for the moment I consider only candidates preserving onset place identity (as in (72), (74)) and maintaining root-final consonants. [ʋ] represents a labio-dental approximant.

(76) Non-nasal codas are prohibited

RED-fuel	IDENT-IO/BR[OBS-PI] IDENT-IO/BR[APR-PI]	*C-PL/X	MAX-IO MAX-BR
a. fu- fuel		f, f, l	eI(BR)
b. ful- fuel		f, l, f, l!	e(BR)
c. fu ^u -fuel	*!(BR-APR-PI)	f, ^u f, l	e(BR)

In contrast to oral consonants, nasals are retained in codas, although they must be place-linked. To achieve this outcome, IDENT[NAS-Place] must be outranked by MAX, as shown in (77). The difference between nasal versus oral consonants is thus that nasals in codas will share place features with a following onset at the cost of place feature identity, while oral consonants in codas will be lost rather than violate place-identity through assimilation.

(77) Nasal codas occur (place-linked)

RED-puɔni	IDENT[OBS-PI] IDENT[APR-PI]	*PL/X	MAX-IO MAX-BR	IDENT-IO/BR[NAS-PI]
a. pu ^m -puɔni		p, ^m p, n	ɔi(BR)	*(BR)
b. pun-puɔni		p, n, p, n!	ɔi(BR)	
c. pu-puɔni		p, p, n	ɔni!(BR)	

The final aspect of the Mbe CodaCond to be explained is the failure of coda restrictions to apply in root-final position. Recall that coda restrictions are lifted not only when root-final consonants are word-final, but also when a root-final consonant occurs before a suffix consonant (see n. 11). If it is the case that root-final position is a position of release, then this exemption could simply be a consequence of faith sensitive to surface release positions. However, the release status of root-final consonants is not discussed in the descriptions of Mbe. If it were that case that root-final consonants are not released,

then with the rankings as they stand, situating *C-PL/X over MAX-IO, root-final consonants before a consonant-initial suffix would be expected to delete (or place-assimilate in the case of nasals).²⁹ In this eventuality, I suggest that the exceptionality of root-final consonants is another consequence of positional faith constraints, in this case specific to the root-final segment. The need for edge-sensitive faith constraints is noted by McCarthy and Prince (1995: 371), who propose anchoring constraints enforcing faith for edge material. In Mbe, it is the segment at the right edge of the root that receives privileged faith status, both in segmental correspondence and featural identity. I express the needed position-sensitive faith constraints as anchoring constraints in (78). The anchoring constraint formulation proposed by McCarthy and Prince demands a correspondent for peripheral segments, as in (78a). This kind of correspondence relation is of the MAX family, as I have noted in the name of the constraint. I add to this (78b), which enforces identity of featural properties for peripheral segments.

(78) a. RIGHT-ANCHOR-MAX_{ROOT}:

Any segment at the right edge of the root in the input has a correspondent at the right edge of the root in the output.

²⁹ Note that even if root-final consonants are not *phonetically*-released in Mbe (which is an empirical question), it is conceivable that root-final position is phonologized as a location in which consonants are released. This could be derived through an opaque constraint interaction where the sympathy candidate is one in which the root-final position is also Pwd-final (and is thus released). Whether there is any independent evidence for this approach is an interesting question to pursue in further research of the Mbe language.

b. RIGHT-ANCHOR-IDENT_{ROOT}[Place]:

Let α be a segment at the right edge of the root in the input and β be a correspondent of α at the right edge of the root in the output. If α is [Place γ], then β is [Place γ].

(Correspondent segments at the right edge of the root are identical in Place features)

Since MAX and IDENT right-anchoring constraints save consonants and their place features in root-final position, they must outrank *C-PL/X. This is illustrated in (79-80) for suffixed forms [jùab-kî] ‘be washing’ and [jĩem-kì] ‘be singing’.

(79) Codas without linked place can occur in root-final position

	juab - ki	R-ANCHOR-MAX _{RT}	R-ANCHOR-ID _{RT} [PI]	*PL/X
☞	a. juab-ki			j, b, k
	b. jua-ki	*!		j, k
	c. juag̃-ki		*!	j, g̃k

(80) Root-final nasals without linked place

	jiem - ki	R-ANCHOR-MAX _{RT}	R-ANCHOR-ID _{RT} [PI]	*PL/X
☞	a. jiem-ki			j, m, k
	b. jie-ki	*!		j, k
	c. jieŋ̃-ki		*!	j, ŋ̃k

We now have completed the rankings which obtain the Mbe CodaCond, which holds within roots and prefixes, including the reduplicative prefix in imperative verbs. The analysis draws on the insights of earlier accounts calling on markedness and (positional) faith constraints (Padgett 1995b, Alderete et al. 1996), and they serve to explain why codas

are restricted to place-linked nasals except in root-final position. It has emerged that the special status of nasals with respect to codas is a consequence of the relatively weak salience of place in nasals, reflected analytically by a low-ranked place feature identity constraint for nasals (after Padgett 1995b). The rankings established for the coda restrictions are summarized in (81).

(81) Summary of rankings for CodaCond:

IDENT_{REL}-IO/BR[Place], IDENT-IO/BR[OBS-Place], IDENT-IO/BR[APR-Place]
ONSET, HAVEPLACE, R-ANCHOR-MAX_{ROOT}, R-ANCHOR-IDENT_{ROOT}[Place]
|
*C-PLACE/X
|
MAX-IO, MAX-BR
|
IDENT-IO/BR[NAS-Place]

Before concluding this appendix, I briefly examine nasal copy in the formation of perfective verbs. This discussion is included for completeness, but the analysis should be considered as only tentative. The goal of this last segment to outline how place markedness constraints already employed in the analysis of Mbe could be extended to offer explanation for an independent restriction in perfective nasal copy. Perfective verbs are formed with a prefix [me-] (82). Perfective verbs also exhibit the third and last instance in Mbe of a prefixal place-linked nasal segment alternating with zero (examples (c-e)):

(82)	<u>Perfective verb form</u>	<u>Gloss</u>
a.	mê - tá	'has touched'
b.	mê - júbò	'has gone out'

- | | | |
|----|--------------|--------------|
| c. | mém̀ - bàm̀ | ‘has hidden’ |
| d. | méǹ - lám | ‘has cooked’ |
| e. | mé̀j̀ - jíem | ‘has sung’ |

Nasal copy in the perfective differs from the previous cases we have seen in an important way: the copied nasal in perfective formation is syllabic and transcribed as tone bearing, while in diminutive, inchoative, and imperative formation it is syllabified as a coda and is not tone-bearing. In commenting on this, Bamgbose (1971: 104-105) notes that a CVN syllable does not generally contrast with an open syllable followed by a syllabic nasal in Mbe; however, in support of positing a syllabic nasal in the case of perfective affixation (aside from its transcribed tone-bearing character), he observes that the nasal does not produce reduction of /e/ to [ə] in the [me-] prefix. If the nasal formed a syllable coda, this absence of reduction would be unexpected, since /e/ allophonically reduces to [ə] in closed syllables throughout the language.³⁰ It is particularly interesting to contrast the consistently full vowel of [me-] with the reduced quality of the vowel in the [re-] inchoative prefix when followed by a nasal.³¹

The copied nasal that occurs in perfective formation is also exceptional in a second respect: it can copy a nasal in the verb stem in the usual way or it can copy a syllabic nasal

³⁰ Transcription of [e] in roots in the Mbe data given earlier follows Bamgbose’s phonemic transcription and does not reflect this reduction.

³¹ In discussing the coda status of copied nasals, Bamgbose (1971: 104-5) also raises the interesting and rather unexpected point that in imperative reduplicants closed by a nasal, the high vowels [i] and [u] occur freely; but in general in Mbe [i] and [u] occur only rarely in closed syllables. This is an example of what Spaelti (1997) calls ‘The Emergence of the Marked’ in reduplication, a case where identity between base and reduplicant correspondents yields a structure in reduplicants that does not otherwise normally occur in the language. Spaelti documents several examples of this kind. The problem that arises in obtaining this sort of outcome is in preventing the deletion of the base segment in order to avoid producing the marked structure. The deletion outcome is what would be expected under a ranking where MAX-IO was simply dominated by the constraint forbidding high vowels in closed syllables (which I will refer to as $*i/uC]_{\sigma}$). Spaelti (1997: 85) observes that the kind of ranking configuration needed is something like the following: $X \gg *i/uC]_{\sigma} \gg \text{MAX-IO} \gg \text{MAX-BR}$, where the constraint ‘X’ achieves the effect of ‘do not delete the high vowel’. I will not pursue the details of this case further here and leave a deeper investigation of the emergence of the marked for future research.

pronoun to its left. Correspondence to a nasal pronoun is not possible in the other cases of nasal agreement (compare inchoative forms below).

(83)	<u>Perfective verb form</u>	<u>Gloss</u>
a.	̀̀ n̄ m̄n̄ - tá	'I have touched'
	̀̀ o m̄e - tá	'you have touched'
b.	̀̀ n̄ m̄m̄ - b̄órò	'I have helped'
	̀̀ e m̄e - b̄órò	'he has helped'
c.	̀̀ n̄ m̄n̄ - lál	'I have slept'
	̀̀ e m̄e - lál	'it has slept'
	<u>Inchoative verb form</u>	<u>Gloss</u>
d.	̀̀ n̄ r̄e - l̄s̄ èts̄í	'I have started to burn the tree'
	*r̄èní - l̄s̄	
e.	̀̀ n̄ r̄e - b̄órò b̄ùts̄í	'I have started to help the friend'
	*r̄èní - b̄órò	

Although fascinating, the availability of copy of material in a preceding pronoun will not be analyzed here. I will simply note that it is possible that the syllabic status of the copied nasal in perfective forms may contribute to the availability of this alternative.

On the strength of the evidence from diminutive and inchoative prefixations for a separate RED affix in nasal segment/null copy, I assume that affixation in perfective verbs is also complex, consisting of a prefix [me-] and a separate purely reduplicative prefix. I hypothesize that the syllabic status of the copied nasal in perfective prefixation is driven by a requirement that reduplicated perfective prefix material coincide with a tone. I will refer to this requirement as PERF/TONE, noting that this could perhaps be captured with an affix-to-tone alignment constraint. Because perfective reduplication adds a syllable in order to

satisfy this constraint, PERF/TONE and REALIZEMORPH_{perf} must outrank the size-restrictor ALLσL:

(84) PERF/TONE, REALIZEMORPH_{perf} >> ALLσL

The question is, if the perfective reduplicant can constitute a syllable, why is it not realized as V(N), which would better satisfy syllable peak markedness and MAX-BR? I suggest that the answer may be found in place markedness constraints. These prohibit the occurrence of place features, and in the case of the coda condition, they drive the place-linked status of coda nasals. The reduplicative syllabic nasal prefix is distinguished by its satisfaction of this constraint: it does not add a place feature to the word. We have already established that *C-PL/X outranks MAX-BR. If it also outranked the demand of the morpheme realization for the perfective, copy would take place only when it did not add a place feature. Up until now, I have made use only of *C-PL/X, which prohibits consonantal place features. Perfective reduplication can also not add vowel place features (recall from 6.1.2 that linking of vowel features across syllables is disallowed). The ban on C-Place and V-Place features being introduced by the perfective morpheme is expressed by the ranking in (85).³²

(85) *C-PL/X, *V-PL/X >> REALIZEMORPH_{perf}

³² It should be noted that this treatment of syllabic nasals as syllables containing a nasal consonant in the nucleus is only tentative. Some analysts have argued that so-called syllabic nasals must correspond to a VN representation, in which the vowel is reduced (i.e. schwa) (see, e.g., Ní Chiosáin and Padgett 1997 for review of this issue). If the VN representation were required, then this could provide further evidence for schwa as a placeless vowel in Mbe.

The following tableaux illustrate the effect of these rankings. First, (86) shows a case where a nasal is copied from the verb stem. Here morpheme realization and the requirement that the perfective prefix coincide with a tone compel the addition of a syllable.

(86) Copied nasal is syllabic

	me - RED - bamo	*C-PL/X *V-PL/X	PERF/TONE REALIZEMORPH _{perf}	ALLσL
☞	a. .mé.m̄.bá.mò.	*****		*****
	b. .mēm̄.bá.mò.	*****	*!	***
	c. .mê.bá.mò.	*****		***
	d. .mé.bàm̄.bá.mò.	*****!*		*****

The tableau in (87) shows an example where morpheme realization fails because there is no available nasal to copy and copying other material would necessitate adding a place feature:

(87) Copy fails when no nasal in stem

	me - RED - ta	*C-PL/X *V-PL/X	PERF/TONE REALIZEMORPH _{perf}	ALLσL
☞	a. .mê.tá.	****	*	*
	b. .mé.tà.tá.	*****!*		***

The above rankings have shown that place markedness constraints outrank ALLσL. Earlier it was established that ALLσL dominated realization constraints for the diminutive and inchoative morphemes. This ranking is consistent with the position of *C-PL/X, since realization of the diminutive and inchoative morphemes does not compel violations of place markedness constraints. It also has been determined that the realization constraint for the imperative dominates ALLσL. Since imperative reduplication does introduce additional

place features, the imperative realization constraint must also outrank *C-PL/X and *V-PL/X. The domination of MAX-BR by ALL σ L will keep reduplicant size down to a syllable.³³ Similarly, in nominal affixation, whatever constraint forces some nominal class affix to appear will have to outrank place markedness constraints.

6.2 Cooccurrence effects in Bantu

In this section I examine a nasal agreement phenomenon occurring in certain Bantu languages (Johnson 1972; Howard 1973; Ao 1991; Odden 1994; Hyman 1995; Piggott 1996). I suggest that this nasal agreement is not a case of [+nasal] feature spreading, but rather the result of a cooccurrence restriction, paralleling a set of other languages having cooccurrence restrictions over segments with similar but different properties. The motivation for a cooccurrence analysis is sketched here and the details are left for further research.

I exemplify the nasal agreement pattern with data from Kikongo, spoken in southwestern Zaire. In Kikongo suffixes, a voiced oral segment realized as either [l] or [d],³⁴ becomes a nasal [n] when a nasal stop occurs anywhere in the root. This is shown in (88) for three different suffixes. The data in (88a-b) are from Ao (1991). The first form in (88c) is from Piggott (1996 drawing on Bentley 1887, Laman 1936) and the second form is from Odden (1994). Root-suffix combinations compose the morphological domain of the stem. In the following data, roots are underlined: note that prefix nasals do not trigger suffixal nasal agreement, since they occur outside of the stem domain. I will not be concerned with the [l] ~ [d] variation here and show the oral alternant of the segment as [l] uniformly.

³³ Something further will be required to explain why the imperative reduplicant does not simply consist of a syllabic nasal when there is a nasal in the base to copy (which is predicted by C-PL/X >> MAX-BR if no more is said). This could be attributed to a prosodic constraint on the imperative reduplicant requiring that it match the canonical form of a verb root (minimally CV: Bamgbose 1967a).

³⁴ This segment is realized as [d] before [i] (Bentley 1887: 624).

(88) Kikongo

a. Perfective passive: [-ulu]/[-unu]

m- <u>bul</u> -ulu	'I was hit'
n- <u>suk</u> -ulu	'I was washed'
masangu ma- <u>kin</u> -unu	'the maize was planted'
masangu ma- <u>nik</u> -unu	'the maize was ground'

b. Perfective active: [-il]/[-in]

m- <u>bud</u> -idi	'I hit'
n- <u>suk</u> -idi	'I washed'
tu- <u>kun</u> -ini	'we planted'
tu- <u>nik</u> -ini	'we ground'

c. Applicative: [-il]/[-in]

<u>sakid</u> -ila	'to congratulate for'
<u>kudumuk</u> -is-ina	'to make jump for'

Interestingly, there is no limitation on the distance between the alternating suffix segment and the nasal in the root. Also intervening vowels and voiceless obstruents are unaffected, remaining oral. This kind of suffix alternation between [l] and [n] occurs in several other Bantu languages, including Luba (Johnson 1972; Howard 1973), Lamba (Doke 1938), Bemba, Tonga, Suku, and Yaka (the last four listed in Hyman 1995; in some cases, e.g. Lamba, there is a requirement that no consonants intervene between the root nasal and suffix consonant).

Ao (1991) gives the following examples from Kikongo to show that a nasal-obstruent sequence does not cause the suffix segment to become nasalized, nor does it prevent a preceding nasal from bringing about the nasalization. These nasal-obstruent sequences are analyzed as prenasalized stops by Piggott (1996) (Hyman 1995 makes a similar assumption for Yaka).

- | | | | |
|------|----|----------------------|------------------------------|
| (89) | a. | tu- <u>bing</u> -idi | 'we hunted' |
| | | tu- <u>bing</u> -ulu | 'we were hunted' |
| | | tu- <u>kong</u> -idi | 'we tied' |
| | | tu- <u>kong</u> -olo | 'we were tied' ³⁵ |
| | b. | tu- <u>meng</u> -ini | 'we hated' |
| | | tu- <u>meng</u> -ono | 'we were hated' |
| | | tu- <u>mant</u> -ini | 'we climbed' |
| | | wu- <u>mant</u> -unu | 'it was climbed' |

The data in (88-89) show the nasal agreement in suffix consonants. Nasal agreement does not induce oral/nasal alternations in root segments; however, as noted by Ao (1991: 195-96, n. 3) and confirmed by Piggott (1996 drawing on dictionary listings of Bentley 1887 and Laman 1936), a voiced consonant never occurs to the right of a nasal stop anywhere in a stem; a root such as [mab] is thus ill-formed. The distributional facts for Kikongo may thus be stated as in (90) (following Piggott 1996):

³⁵ Kikongo exhibits a height harmony in suffix vowels such that the high vowels [i, u] lower to [e, o] when the root vowel is [e, o].

(90) Kikongo consonant distribution:

Within a stem, a voiced consonant to the right of a nasal consonant is a nasal.

The first question for an analysis of this distribution is what phonological mechanism brings about the nasal distribution in (90)? In previous work, this nasal agreement phenomenon has been analyzed as the result of spreading of [+nasal] (e.g. Ao 1991, Odden 1994, Hyman 1995, Piggott 1996). However, there are two significant respects in which this nasal agreement differs from all of the cases of nasal spreading documented in the nasal harmony database (summarized in chapter 2). First, the nasal agreement is non-local, that is, the root nasal and the alternating suffix consonant are non-adjacent, and in some cases, are separated by multiple syllables. This contrasts with the important generalization established by the study of nasal harmony in chapter 2 that [+nasal] spreading occurs only between strictly adjacent segments. Second, the set of target segments does not obey the nasal compatibility hierarchy. If the nasal agreement in Kikongo were nasal spreading, it would have to be posited as targetting all voiced consonants and not vocoids. This differs from the systematic finding of the nasal harmony database that nasal spreading targetting consonants also targets vowels (as predicted by vowels being higher-ranked on the nasal compatibility scale). Given these considerable differences from the core generalizations established for nasal spreading, I reject the possibility that the Bantu nasal agreement is a feature spreading phenomenon. Since the nasal agreement can occur anywhere within a stem and involves featural change rather than the presence or absence of a segment, I also reject the possibility of a reduplication phenomenon (i.e. segment copy).

With spreading and reduplication ruled out, I turn to another kind of phonological mechanism which has not yet been considered, namely, cooccurrence restrictions. Cooccurrence restrictions refer to conditions excluding similar sound elements in a word or

some other domain. I suggest that analyzing the Bantu nasal agreement effects along these lines explains both its non-locality and the kinds of segments targeted.

In the history of analysis of cooccurrence conditions, an analytical breakthrough came with advent of autosegmental representations and the proposed Obligatory Contour Principle (OCP), which bans adjacent identical elements (e.g. segments, features, tones) at some level of phonological structure (Leben 1973; McCarthy 1979, 1981, 1986; Mester 1986). Although the OCP served to explain many cooccurrence effects, several analysts have noted that its locality requirement (i.e. adjacency on a tier) is too restrictive for some cooccurrence phenomena which appear to occur at any distance within some domain, such as the word (Jones 1997; Walker 1997c; Flemming 1998; see also Itô and Mester 1996, Alderete 1997c, who formulate an OCP constraint without a locality requirement, and Pierrehumbert 1993a, Frisch, Broe, and Pierrehumbert 1997, who propose a gradient and quantitative approach). This application of cooccurrence restrictions to any similar (or identical) segments within some domain matches the non-local character of the Bantu nasal agreement.

Another way in which the Bantu nasalization resembles cooccurrence restrictions of certain other languages concerns the set of segments targeted by the restriction. An important observation that has received little attention in the study of cooccurrence effects is that the restrictions do not always simply exclude *identical* elements; in some cases they exclude *similar but different* elements within some domain (Odden 1994; Mester 1986; Sagey 1986; Walker 1997c, Flemming 1998). An example of the latter kind comes from Ngbaka, a Niger-Congo language, reported by Thomas (1963) and discussed by Mester (1986) and Sagey (1986). Ngbaka arrays its consonants according to a hierarchy, as in (91) (following Mester 1986: 41). It exhibits a cooccurrence restriction in words such that for each place of articulation, adjacent elements on the scale are forbidden. Non-adjacent or

identical elements are compatible. Thus, nasal and prenasal are excluded together, also prenasal and voiced (oral), and voiceless with voiced (oral).

- (91) voiceless obstruent - voiced obstruent - prenasalized voiced obstruent - nasal
 e.g. [p] [b] [mb] [m]

Kera, (Chadic) exhibits a similar restriction banning a mix of voiced and voiceless stops/affricates within the word (Ebert 1979; Odden 1994). This restriction induces voicing in affix stops when the stem contains a voiced consonant (e.g. /ki-d̪ir-ki/ → [gi-d̪-ir-gi] 'colorful' (masc.); cf. [ki-sar-ki] 'black' (masc.)). The cooccurrence restrictions in Ngbaka and Kera are strikingly similar to the nasal agreement phenomenon in Kikongo: two similar but different segments in a nasality and/or voicing continuum are excluded within the word/stem (with place of articulation adding to similarity in Ngbaka). Segments that are sufficiently similar or sufficiently different are allowed to cooccur. In Kikongo, voiced consonants qualify as insufficiently similar and insufficiently different from nasals. This may be understood as inducing the nasalization of voiced consonants in Kikongo suffixes when the root contains a nasal. Kikongo differs from Ngbaka in permitting prenasal segments to cooccur with nasal and voiced consonants. Prenasal stops thus appear to meet the required similarity threshold with segments matching in nasality or voicing in Kikongo; the similarity threshold in Ngbaka is somewhat less permissive.

To review, although the Kikongo pattern of nasal agreement may at first appear to be a completely different type of nasal harmony (with [+nasal] feature spreading), the consonant distribution patterns of languages like Ngbaka and Kera indicate that it shares much in common with cooccurrence restrictions holding over similar but different elements. Accordingly, I propose that an analysis of Bantu nasal agreement should fall under a cooccurrence account. Cooccurrence effects applying to similar but different

elements have been little studied, because they are not immediately well-accounted for by the OCP (but see, e.g., Mester 1986 for a proposal concerning Ngbaka). I will not develop an account of such restrictions here, but note that there are five focal issues to be examined in future research: these are (i) the object of the cooccurrence restriction: this can hold over identical sound properties or similar but different ones, (ii) locality: different apparent requirements occur, e.g. segmental adjacency, syllable adjacency, or membership in the same word (but see Flemming 1998, who reanalyzes some of these apparent requirements), (iii) blocking and directionality: a specific type of intervening segment in some cases blocks the cooccurrence effect (e.g. Gurundji; Jones 1997); in some instances the cooccurrence effect seems to be directional (e.g. Kikongo), (iv) resolution: the conflicting sounds either dissimilate (become less alike) or they assimilate (become more alike), (v) motivation: what drives the cooccurrence effect? Flemming (1998) suggests that contrast demands can play a role; Walker (1997c) notes that speech planning may contribute to the effect. This is clearly a rich domain for further research.

References

- Abrahamson, Arne. 1968. Contrastive distribution of phoneme classes in Içuã Tupi. *Anthropological Linguistics* 10.6, 11-21.
- Aikhionbare, Matt. Osayaba. 1989. Defining the domain of nasality in Edo. *Studies in African Linguistics* 20.3, 301-315.
- Akinlabi, Akinbiyi. 1996. Featural affixation. *Journal of Linguistics* 32, 239-289.
- Akinlabi, Akinbiyi. To appear. Kalabari vowel harmony. *The Linguistic Review*.
- Alderete, John. 1995. Faithfulness to prosodic heads. Ms., University of Massachusetts, Amherst.
- Alderete, John. 1996. Prosodic faithfulness in Cupeño. Ms., University of Massachusetts, Amherst.
- Alderete, John. 1997a. Root-controlled accent in Cupeño. Ms., University of Massachusetts, Amherst.
- Alderete, John. 1997b. Dissimilation as local conjunction. In Kiyomi Kusumoto, ed., *Proceedings of NELS 27*, pp. 17-32. GLSA.
- Alderete, John, Jill Beckman, Laura Benua, Amalia Gnanadesikan, John McCarthy, and Suzanne Urbanczyk. 1996. Reduplication and segmental unmarkedness. Ms., University of Massachusetts, Amherst.
- Alexander, Ruth Mary. 1980. *Gramática mixteca de Atlatluuca*. Mexico City: Summer Institute of Linguistics.
- Allen, W. S. 1951. Some prosodic aspects of retroflexion and aspiration in Sanskrit. *Bulletin of the School of Oriental and African Sciences* 13, 936-946.
- Anderson, Stephen R. 1976. Nasal consonants and the internal structure of segments. *Language* 52, 326-344.
- Ao, Benjamin. 1991. Kikongo nasal harmony and context-sensitive underspecification. *Linguistic Inquiry* 22, 193-196.
- Archangeli, Diane, and Douglas Pulleyblank. 1994. *Grounded Phonology*. Cambridge, Mass.: MIT Press.
- Arnaiz, A. 1988. Nasalization in Orejon. Ms., USC.
- Bamgbose, Ayo. 1966a. Nominal classes in Mbe. *Afrika und Übersee* 49, 32-53.
- Bamgbose, Ayo. 1966b. *A Grammar of Yoruba*. Cambridge: Cambridge University Press.

- Bamgbose, Ayo. 1967a. Verbal classes in Mbe. *Afrika und Übersee* 50, 173-193.
- Bamgbose, Ayo. 1967b. Tense/aspect forms in Mbe. *Research Notes*, Department of Linguistics and Nigerian Languages, University of Ibadan, 1, 12-20.
- Bamgbose, Ayo. 1967c. Notes on the Phonology of Mbe. *Journal of West African Languages* 4, 5-11.
- Bamgbose, Ayo. 1969. Yoruba. In Elizabeth Dunstan, ed., *Twelve Nigerian Languages*, pp. 163-172.
- Bamgbose, Ayo. 1971. Nasal harmony in Mbe. *Annales de l'Université d'Abidjan* 1971, Série H, Fascicule hors série, Vol. 1, pp. 101-107.
- Barnes, Janet. 1996. Autosegments with three-way contrasts in Tuyuca. *International Journal of American Linguistics* 62, 31-58.
- Barnes, Janet. and Terrell Malone. 1988. El tuyuca. Ms., Lomalinda, Meta, Colombia.
- Barnes, Janet, and Sheryl Takagi de Silzer. 1976. Fonología del tuyuca. *Sistemas fonológicos de idiomas colombianos* 3, pp. 123-137. Traducción al español por Jorge Arbeláez B. y Hno. Bernardo Montes U. Lomalinda, Meta, Colombia: Instituto Lingüístico de Verano.
- Basbøll, Hans. 1977. The structure of the syllable and the proposed hierarchy of phonological features. In W. Dressler et al., eds., *Phonologica 1976*, pp. 143-148. Innsbruck: Institut für Sprachwissenschaft.
- Beckman, Jill N. 1995. Shona height harmony: Markedness and positional identity. In Jill N. Beckman, Laura Walsh Dickey, & Suzanne Urbanczyk, eds., *University of Massachusetts Occasional Papers: Papers in Optimality Theory* 18, 53-75.
- Beckman, Jill N. 1997. Positional faithfulness, positional neutralization, and Shona height harmony. *Phonology* 14, 1-46.
- Beckman, Jill N. 1998. *Positional Faithfulness*. Doctoral dissertation, University of Massachusetts, Amherst.
- Beddor, Patrice S. 1983. *Phonological and Phonetic Effects of Nasalization on Vowel Height*. (Doctoral dissertation, University of Minnesota, 1982.) Bloomington, Ind.: Indiana University Linguistics Club.
- Bell-Berti, Fredericka. 1993. Understanding velic motor control: Studies of segmental context. In Huffman and Krakow, eds., pp. 63-85.
- Bendor-Samuel, J. T. 1960. Some problems of segmentation in the phonological analysis of Tereno. *Word* 16, 348-55.
- Benguerel, A.-P. 1974. Nasal airflow patterns and velar coarticulation in French. In *Speech Communications Seminar Proceedings*, Volume 2, pp. 105-112. Stockholm: Almqvist and Wiksell.

- Bentley, William H. 1887. *Dictionary and Grammar of the Kongo Language*. London: Baptist Missionary Society.
- Benua, Laura. 1995. Identity effects in morphological truncation. In Jill N. Beckman, Laura Walsh Dickey, & Suzanne Urbanczyk, eds., *University of Massachusetts Occasional Papers: Papers in Optimality Theory* 18, 77-136.
- Benua, Laura. 1997. *Transderivational Identity: Phonological Relations between Words*. Doctoral dissertation, University of Massachusetts, Amherst.
- Bhaskararao, Peri, and Peter Ladefoged. 1991. Two types of voiceless nasals. *Journal of the International Phonetic Association* 21, 80-88.
- Bird, Steven, and Ewan Klein. 1990. Phonological events. *Journal of Linguistics* 26, 33-56.
- Bivin, William. 1986. *The Nasal Harmonies of Twelve South American Languages*. MA thesis. University of Texas at Arlington.
- Blust, Robert. 1977. Sketches of the morphology and phonology of Bornean Languages 1: Uma Juman (Kayan). *Papers in Borneo and Western Linguistics* No. 2. Pacific Linguistics A33, 7-122.
- Blust, Robert. 1988. Sketches of the morphology and phonology of Bornean languages 2: Mukah (Melanau). *Papers in Western Austronesian Linguistics* No. 3. Pacific Linguistics A78, 156-216.
- Blust, Robert. 1996. Nasals and nasalization in Borneo. Ms., University of Hawaii.
- Brame, Michael. 1972. On the abstractness of phonology: Maltese ʔ . In Michael Brame, ed., *Contributions to Generative Phonology*, pp. 22-61. Austin: University of Texas Press.
- Bridgeman, Loraine I. 1961. Kaiwa (Guarani) Phonology. *International Journal of American Linguistics* 27, 329-334.
- Broselow, Ellen, and John McCarthy. 1983. A theory of internal reduplication. *The Linguistic Review* 3, 25-98.
- Browman, Catherine, and Louis Goldstein. 1986. Towards an articulatory phonology. *Phonology Yearbook* 3, 219-252.
- Browman, Catherine, and Louis Goldstein. 1989. Articulatory gestures as phonological units. *Phonology* 6, 201-251.
- Browman, Catherine, and Louis Goldstein. 1990. Tiers in articulatory phonology, with some implications for casual speech. In Kingston and Beckman, eds., pp. 341-376.

- Burgess, Eunice and Patricia Ham. 1968. Multilevel conditioning of phoneme variants in Apinayé. *Linguistics* 41, 5-18.
- Burzio, Luigi. 1997. Multiple correspondence. Ms., Johns Hopkins University.
- Byrd, Dani. 1992. Perception of assimilation in consonant clusters: A gestural model. *Phonetica* 49, 1-24.
- Capo, Hounkpatin C. 1981. Nasality in Gbe: A synchronic interpretation. *Studies in African Linguistics* 12.1, 1-43.
- Causley, Trisha. 1996. Featural correspondence and identity: The Athapaskan case. Paper presented at *NELS* 27, McGill University.
- Chafe, Wallace L. 1967. Seneca Morphology and Dictionary. *Smithsonian Contributions to Anthropology* 4. Washington D.C.: Smithsonian Press.
- Cho, Young-Mee Yu. 1990. *Parameters of Consonantal Assimilation*. Doctoral dissertation, Stanford University.
- Chomsky, Noam, and Morris Halle. 1968. *The Sound Pattern of English*. Cambridge Mass.: MIT Press.
- Clark, Mary M. 1990. *The Tonal System of Igbo*. Dordrecht: Foris Publications.
- Clements, G. N. 1976. Neutral vowels in Hungarian vowel harmony: An autosegmental interpretation. *NELS* 7, 49-64.
- Clements, G. N. 1985. The geometry of phonological features. *Phonology Yearbook* 2, 225-252.
- Clements, G. N. 1990. The role of the sonority cycle in core syllabification. In Kingston and Beckman, eds., pp. 283-333.
- Coady, James, and Richard McGinn. 1982. On the so-called implosive nasals of Rejang. In Carle Rainer et al., eds., *GAVA: Studies in Austronesian Languages and Cultures Dedicated to Hans Kähler*, pp. 437-439. Veröffentlichungen des Seminars für Indonesische und Südseesprachen der Universität Hamburg, Band 17. Berlin: Reimer.
- Cohn, Abigail. 1990. *Phonetic and Phonological Rules of Nasalization*. (Doctoral dissertation, UCLA, 1990.) *UCLA Working Papers in Linguistics* 76.
- Cohn, Abigail. 1993a. The status of nasalized continuants. In Huffman and Krakow, eds., pp. 329-367.
- Cohn, Abigail. 1993b. Nasalization in English: Phonology or phonetics. *Phonology* 43, 81.
- Cohn, Abigail. 1993c. A survey of the phonology of the feature [\pm nasal]. *Working Papers of the Cornell Phonetics Laboratory* 8, 141-203.

- Cole, Jennifer, and Charles Kisseberth. 1994. An optimal domains theory of harmony. Cognitive Science Technical Report UIUC-BI-CS-94-02 (Language Series). Beckman Institute, University of Illinois.
- Cole, Jennifer, and Charles Kisseberth. 1995. Nasal harmony in optimal domains theory. Cognitive Science Technical Report UIUC-BI-CS-95-02 (Language Series). Beckman Institute, University of Illinois.
- Condax, I. D., I. Howard, K. Ikranagra, Y. C. Lin, J. Crosetti, D. E. Yount. 1974. A new technique for demonstrating velic opening: application to Sundanese. *Journal of Phonetics* 2, 297-301.
- Constenla, Adolfo. 1985. Prosodic nasality in Bribri (Chibchan) and universals of nasality. *International Journal of American Linguistics* 51.4, 374-376.
- Court, Christopher. 1970. Nasal harmony and some Indonesian sound laws. In S. A. Wurm and D. C. Leycock, eds. *Pacific Linguistic Studies in Honour of Arthur Capell*. *Pacific Linguistics*, Series C, No. 13, pp. 203-217. Canberra: The Australian National University.
- Crowhurst, Megan J. 1998. Some phonological differences between Guaraní-Ava and Guaraní (Tupí-Guaraní). Paper presented at the annual meeting of the Society of the Indigenous Languages of the Americas.
- Dalston, R. M. 1982. Photodetector assessment of velopharyngeal activity. *Cleft Palate Journal* 19, 1-8.
- Dantsuji, Masatake. 1986. Some acoustic observations on the distinction of place of articulation for voiceless nasals in Burmese. *Studia Phonologica* 20: 1-11.
- Davis, Stuart. 1997. A sympathetic account of nasal substitution in Ponapean reduplication. In Rachel Walker, Motoko Katayama, and Daniel Karvonen., eds., *Phonology at Santa Cruz* 5, 15-28.
- Dell, Francois. 1973. *Les Règles et les Sons. Introduction à la Phonologie Générative*. Hermann, Paris.
- Doke, Clement M. 1938. *Textbook of Lamba Grammar*. Johannesburg: Witwatersrand University Press.
- Dressler, Wolfgang. 1972. Allegroregeln rechtfertigen Lentoregeln. *Innsbrucker Beiträge zur Sprachwissenschaft* 9, Institut für Sprachwissenschaft, Innsbruck University.
- Dunselman, Donatus P. 1949. Bijdrage tot de kennis van de taal en adat der Kendajan Dajaks van West Borneo. *Bijdr. Taal-, Land-, Volkenk. Ned. -Ind.*, 105, 61-105.
- Durie, Mark. 1985. *A Grammar of Acehese on the Basis of a Dialect of North Aceh*. Dordrecht: Foris.
- Dyen, Isidore. 1945. *Spoken Malay*. Henry Holt and Co.

- Ebert, Karen. 1979. *Sprache und Tradition der Kera (Tschad). Teil III: Grammatik.* (Marburger Studien zur Afrika- und Asienkunde. Serie A: Afrika.) Berlin: Reimer.
- Einarsson, S. 1940. Nasal + spirant or liquid in Icelandic. *The Journal of English and Germanic Philology* 34, 462-464.
- Fellbaum, Marie. 1981. Nasalization and the markedness constraint. *Minnesota Papers in Linguistics and Philosophy of Language* 7, 55-64.
- Ferguson, Charles A. 1963. Assumptions about nasals: A sample study in phonological universals. In J. H. Greenberg, ed., *Universals of Language*, pp. 53-60. Cambridge, Mass.: MIT Press.
- Ferguson, Charles A. 1975. Universal tendencies and 'normal' nasality. In Ferguson, Hyman, and Ohala., eds., pp. 175-196.
- Ferguson, Charles A., Larry M. Hyman, and John J. Ohala, eds. 1975. *Nasalfest: Papers from a Symposium on Nasals and Nasalization.* Stanford University.
- Flemming, Edward. 1993. *The Role of Metrical Structure in Segmental Rules.* MA thesis, UCLA.
- Flemming, Edward. 1995a. *Auditory Representations in Phonology.* Doctoral dissertation, UCLA.
- Flemming, Edward. 1995b. Vowels undergo consonant harmony. Paper presented at the Trilateral Phonology Weekend 5, University of California, Berkeley.
- Flemming, Edward. 1998. Adjacency and transparency in phonology: Evidence from dissimilation. Paper presented at the Trilateral Phonology Weekend, University of California, Berkeley.
- Frisch, Stefan, Michael Broe, and Janet Pierrehumbert. 1997. Similarity and phonotactics in Arabic. Ms., Indiana University and Northwestern University.
- Gafos, Adamantios. 1996. *The Articulatory Basis of Locality in Phonology.* Doctoral dissertation, Johns Hopkins University.
- Gerfen, Henry James, Jr. 1996. *Topics in the Phonology and Phonetics of Coatzacoapan Mixtec.* Doctoral dissertation, University of Arizona.
- Ghatage, A. M. 1963. *Konkani of South Kanara.* Bombay: The State Board for Literature and Culture.
- Gibson, Lorna F. 1956. Pame (Otomi) phonemics and morphophonemics. *International Journal of Linguistics* 22.4, 242-265.
- Gnanadesikan, Amalia. 1996. *Phonology with Ternary Scales.* Doctoral dissertation, University of Massachusetts, Amherst.

- Goldsmith, John. 1976. *Autosegmental Phonology*. Doctoral dissertation, MIT.
- Goldsmith, John. 1990. *Autosegmental and Metrical Phonology*. Cambridge, Mass.: Blackwell.
- Golston, Chris. 1995. Syntax outranks phonology: evidence from Ancient Greek. *Phonology* 12.3, 343-368.
- Gómez-Imbert, Elsa. 1980. La nasalité en tatuyo: Phonologie ou morphologie? *Amerindia* 5, 65-81.
- Green, M. M., and Rev. G. E. Igwe. 1963. *A Descriptive Grammar of Igbo*. London: Oxford University Press.
- Gregores, Emma, and Jorge A. Suárez. 1967. *A Description of Colloquial Guaraní*. The Hague: Mouton.
- Guasch, Antonio. 1948. *Diccionario guaraní*. Buenos Aires.
- Guasch, Antonio. 1956. *El-idioma guaraní*. Asuncion, Casa America-Moreno Hnos.
- Gudschinsky, Sarah, Harold Popovich, and Frances Popovich. 1970. Native reaction and phonetic similarity in Maxakali phonology. *Language* 46, 77-88.
- Hammond, Michael. 1988. On deriving the well-formedness Condition. *Linguistic Inquiry* 19, 319-325.
- Hankamer, Jorge, and Judith Aissen. 1974. The sonority hierarchy. In M. W. LaGaly, R. A. Fox, and A. Bruck, eds., *CLS 10: Parasession on Natural Phonology*, pp. 131-145. Chicago: CLS.
- Hardcastle, W. J. 1970. The role of tactile and proprioceptive feedback in speech production. (Work in progress 4). Department of Linguistics, Edinburgh University.
- Harms, Phillip L. 1985. Epena Pedee (Saija) nasalization. In Ruth Brend, ed., *From Phonology to Discourse: Studies in Six Colombian Languages*, pp. 13-18. Dallas: Summer Institute of Linguistics.
- Harms, Phillip L. 1994. *Epena Pedee Syntax*. Studies in the Languages of Colombia 4. Summer Institute of Linguistics and University of Texas at Arlington.
- Harrison, Carl H., and John M. Taylor. 1971. Nasalization in Kaiwá. In David Bendor Samuel, ed., *Tupi Studies I*, pp. 15-20. Summer Institute of Linguistics Publications in Linguistics and Related Fields, Publication No. 29. University of Oklahoma, Norman.
- Hart, George. 1981. *Nasality and the Organization of Autosegmental Phonology*. Bloomington, Ind.: Indiana University Linguistics Club.

- Hayes, Bruce. 1995. A phonetically-driven, optimality-theoretic account of post-nasal voicing. Paper presented at the Tilsburg Derivationality Residue Conference.
- Hayes, Bruce, and Tanya Stivers. In progress. The phonetics of postnasal voicing. Ms., UCLA.
- Hendon, Rufus S. 1966. *The Phonology and Morphology of Ulu Muar Malay*. New Haven: Yale University Publications in Anthropology, no. 70.
- Hendricks, Sean. 1998. Shuswap diminutive bare-consonant reduplication. Handout of paper presented at SWOT 4. University of Arizona. Tucson.
- Hetzron, Robert, and Habte Mariam Marcos. 1966. Des traits pertinents superposés en ennemor. *Journal of Ethiopian Studies* 4, 17-30.
- Hoenigswald, Henry M. 1948. Declension and nasalization in Hindustani. *Journal of the American Oriental Society* 68, 139-144.
- Hogan, David W. 1988. *Urak Lawoi': Basic Structures and a Dictionary*. Pacific Linguistics, Series C, no. 109. Canberra: Linguistic Circle of Canberra.
- Hollow, Robert C. 1970. *A Mandan Dictionary*. Doctoral dissertation, University of California, Berkeley.
- Holmer, Nils M. 1952. Seneca II. *International Journal of American Linguistics* 15, 45-56.
- Hooper [Bybee], Joan. 1972. The syllable in phonological theory. *Language* 48, 525-540.
- Hooper [Bybee], Joan. 1976. *An Introduction to Natural Generative Phonology*. New York: Academic Press.
- Howard, Irwin. 1973. *A Directional Theory of Rule Application in Phonology*. (Doctoral dissertation, MIT, 1972.) Bloomington, Ind.: Indiana University Linguistics Club.
- Huffman, Marie K. 1990. Implementation of Nasal: Timing and Articulatory Landmarks. (Doctoral dissertation, UCLA, 1989.) *UCLA Working Papers in Linguistics* 75.
- Huffman, Marie K. 1993. Phonetic patterns of nasalization and implications for feature specification. In Huffman and Krakow, eds., pp. 303-327.
- Huffman, Marie K, and Rena Krakow, eds. 1993. *Nasals, Nasalization, and the Velum. Phonetics and Phonology*, Volume 5. San Diego, Ca.: Academic Press.
- Hulst, Harry van der, and Norval Smith. 1982. Prosodic domains and opaque segments in autosegmental theory. In Harry van der Hulst and Norval Smith, eds., *The Structure of Phonological Representations* (part II), pp. 311-336. Dordrecht: Foris.

- Hulst, Harry van der, and Jeroen van de Weijer. 1995. Vowel Harmony. In John Goldsmith, ed., *The Handbook of Phonological Theory*, pp. 495-534. Cambridge, Mass.: Blackwell.
- Hume, Elizabeth, and David Odden. 1994. Contra [Consonantal]. *Studies in the Linguistic Sciences*, 24.2.
- Hunter, Georgia, and Eunice V. Pike. 1969. The phonology and tone sandhi of Molinos Mixtec. *Linguistics* 47, 24-40.
- Hyman, Larry M. 1970. How concrete is phonology? *Language* 46.1, 58-76.
- Hyman, Larry M. 1982. The representation of nasality in Gokana. In Harry van der Hulst and Norval Smith, eds., *The Structure of Phonological Representations (Part I)*, pp. 111-265. Dordrecht: Foris Publications.
- Hyman, Larry M. 1989. Advanced tongue root in Kinande. Ms., University of California, Berkeley.
- Hyman, Larry M. 1995. Nasal action at a distance: The case of Yaka. *Studies in African Linguistics* 24, 5-30.
- Inkelas, Sharon. 1994. The consequences of optimization for underspecification. Ms., University of California, Berkeley.
- Inkelas, Sharon, C. Orhan Orgun, and Cheryl Zoll. 1996. Exceptions and static phonological patterns: cophonologies vs. prespecification. Ms., University of California, Berkeley and University of Iowa.
- Itô, Junko. 1986. *Syllable Theory in Prosodic Phonology*. Doctoral dissertation, University of Massachusetts, Amherst. [Published by Garland, New York, 1988.]
- Itô, Junko, and Armin Mester. 1993. Licensed segments and safe paths. *Canadian Journal of Linguistics* 38.2, 197-213.
- Itô, Junko, and Armin Mester. 1994. Reflections on CodaCond and alignment. In Jason Merchant, Jaye Padgett, and Rachel Walker, eds., *Phonology at Santa Cruz* 3, 27-46.
- Itô, Junko, and Armin Mester. 1995a. The core-periphery structure of the lexicon: Constraints on reranking. In Jill N. Beckman, Laura Walsh Dickey, & Suzanne Urbanczyk, eds., *University of Massachusetts Occasional Papers: Papers in Optimality Theory* 18, 181-209.
- Itô, Junko, and Armin Mester. 1995b. Japanese phonology. In John Goldsmith, ed., *The Handbook of Phonological Theory*, pp. 817-838. Cambridge, Mass.: Blackwell.
- Itô, Junko, and Armin Mester. 1996. Structural economy and OCP interactions in local domains. Paper presented at WECOL, University of California, Santa Cruz.

- Itô, Junko, and Armin Mester. 1997a. Sympathy theory and German truncations. In Viola Miglio and Bruce Moren, eds., *University of Maryland Working Papers in Linguistics 5* (Selected papers from the Hopkins Optimality Theory Workshop 1997/University of Maryland Mayfest 1997), pp. 117-138.
- Itô, Junko, and Armin Mester. 1997b. Featural sympathy: Feeding and counterfeeding interactions in Japanese. In Rachel Walker, Motoko Katayama, and Daniel Karvonen., eds., *Phonology at Santa Cruz 5*, 29-36.
- Itô, Junko, and Armin Mester. 1997c. Correspondence and compositionality: The Ga-Gyō variation in Japanese phonology. In Iggy Roca, ed., *Derivations and Constraints in Phonology*, pp. 419-462. Oxford University Press.
- Itô, Junko, and Armin Mester. In press. Realignment. In René Kager, Harry van der Hulst, and Wim Zonneveld, eds., *Proceedings of the Utrecht Workshop on Prosodic Morphology*. Mouton.
- Itô, Junko, Armin Mester, and Jaye Padgett. 1995. Licensing and underspecification in Optimality Theory. *Linguistic Inquiry* 26.4, 571-613.
- Iverson, Gregory K., and Joseph C. Salmons. 1996. Mixtec prenasalization as hypervoicing. *International Journal of American Linguistics* 62.2, 165-175.
- Jespersen, Otto. 1904. *Lehrbuch der Phonetik*. Leipzig and Berlin: B. G. Teubner.
- Johnson, C. Douglas. 1972. *Formal Aspects of Phonological Description*. (Monographs on Linguistic Analysis 3.) The Hague: Mouton.
- Jones, Caroline. 1997. Non-adjacency in dissimilation. Paper presented at the Student Phonology Workshop, LSA Institute, Cornell University.
- Jones, Wendell, and Paula Jones. 1991. *Barasano Syntax*. Studies in the Languages of Columbia 2. Publications in Linguistics No. 101. Summer Institute of Linguistics and the University of Texas at Arlington.
- Jun, Jongho. 1995. Place assimilation as the result of conflicting perceptual and articulatory constraints. Paper presented at WCCFL 14.
- Kager, René. 1995. Stem disyllabicity in Guugu Yimidhirr. Ms., OTS, University of Utrecht.
- Karvonen, Daniel. 1998. Finnish loanword phonology and the core-periphery structure of the lexicon. Paper presented at the Trilateral Phonology Weekend, University of California, Berkeley.
- Karvonen, Daniel, and Adam Sherman. 1997a. Opacity in Icelandic: A sympathy account. Paper presented at NELS 28. [Written version to appear in proceedings.]
- Karvonen, Daniel, and Adam Sherman. 1997b. Sympathy, opacity, and u-umlaut in Icelandic. In Rachel Walker, Motoko Katayama, and Daniel Karvonen., eds., *Phonology at Santa Cruz 5*, 37-48.

- Katayama, Motoko. 1998. *Optimality Theory and Japanese Loanword Phonology*. Doctoral dissertation, University of California, Santa Cruz.
- Kawasaki, Haruko. 1986. Phonological universals of vowel nasalization. In John J. Ohala and Jeri Jaeger, eds., *Experimental Phonology*, pp. 81-103. Academic Press.
- Kaye, Jonathan D. 1971. Nasal harmony in Desano. *Linguistic Inquiry* 2.1, 37-56.
- Kaye, Jonathan D. 1982. Harmony processes in Vata. In Harry van der Hulst and Norval Smith, eds., *The Structure of Phonological Representations (Part II)*, pp. 385-452. Dordrecht: Foris.
- Keating, Patricia. 1988. Underspecification in phonetics. *Phonology* 5, 275-292.
- Keating, Patricia. 1990. The window model of coarticulation: Articulatory evidence. In Kingston and Beckman, eds., pp. 451-470.
- Kelly, John. 1969. Urhobo. In Elizabeth Dunstan, ed., *Twelve Nigerian Languages*, pp. 153-161. New York: Africana Publishing Corp.
- Kenstowicz, Michael. 1994. *Phonology in Generative Grammar*. Cambridge, Mass.: Blackwell.
- Kenstowicz, Michael. 1995. Base-identity and uniform exponence: Alternatives to cyclicity. In J. Durand and B. Laks, eds., *Current Trends in Phonology: Models and Methods*. CNRS, Paris-X and University of Salford Publications.
- Key, Harold. 1961. Phonotactics of Cayuvava. *International Journal of American Linguistics* 22, 143-50.
- Key, Harold. 1967. Morphology of Cayuvava. *Janua Linguarum, Studia Memoriae Nicolai van Wijk dedicata*. The Hague: Mouton.
- Kingston, John. 1990. Articulatory binding. In Kingston and Beckman, eds., pp. 406-434.
- Kingston, John, and Mary Beckman, eds. 1990. *Papers in Laboratory Phonology I: Between the Grammar and Physics of Speech*. Cambridge: Cambridge University Press.
- Kingston, John, and Randy L. Diehl. 1994. Phonetic knowledge. *Language* 70.3, 419-454.
- Kiparsky, Paul. 1971. Historical linguistics. In William O. Dingwall, ed., *A Survey of Linguistic Science*, pp. 577-649. College Park: University of Maryland.
- Kiparsky, Paul. 1973. Abstractness, opacity, and global rules. In Osamu Fujimura, ed., *Three Dimensions of Linguistic Theory*, pp. 93-106. Tokyo: Taikusha.

- Kiparsky, Paul. 1981. Vowel harmony. Ms., MIT.
- Kiparsky, Paul. 1982. Lexical morphology and phonology. In Linguistics Society of Korea, ed., *Linguistics in the Morning Calm*, vol. 2, pp. 3-91. Seoul: Hanshin.
- Kiparsky, Paul. 1985. Some consequences of lexical phonology. *Phonology Yearbook* 2, 85-138.
- Kirchner, Robert. 1993. Turkish vowel harmony and disharmony: An optimality theoretic account. Ms., UCLA. of talk presented at the Rutgers Optimality Workshop I.
- Kisseberth, Charles W. 1969. On the abstractness of phonology: The evidence from Yawelmani. *Papers in Linguistics* 1.2, 248-282.
- Kondo, Victor, and Riena Kondo. 1967. Guahibo Phonemes. In Benjamin Elson, ed., *Phonemic Systems of Colombian Languages*, pp. 89-98. Norman, Oklahoma: SIL.
- Kopeseć, Michael F., and Bonnie M. Kopeseć. 1974. La jerarquía fonológica del guaymí. In Patricia Baptista, ed., *Lenguas de Panamá: sistemas fonológicas, Tomo I*, pp. 17-30. Panama City, Panama: Instituto nacional de Cultura.
- Kopeseć, Michael F., and Bonnie M. Kopeseć. 1975. Los elementos verbales y sustantivos y la oración en guaymí. In Stephen H. Levinsohn, ed., *Lenguas de Panamá: observaciones gramaticales. Tomo II*, pp. 19-82. Panama City, Panama: Instituto Nacional de Cultura.
- Krakow, Rena A., and Maria K. Huffman. 1993. Instruments and techniques for investigating nasalization and velopharyngeal function in the laboratory: An introduction. In Huffman and Krakow, eds., pp. 3-59.
- Kurisu, Kazutaka. 1998. Richness of the base and root fusion in Sino-Japanese. Paper presented at the Trilateral Phonology Weekend, University of California, Berkeley.
- Ladefoged, Peter. 1971. *Preliminaries to Linguistic Phonetics*. (Midway reprint 1981.) Chicago: University of Chicago Press.
- Ladefoged, Peter. 1993. *A Course in Phonetics*. Orlando, Fl.: Harcourt, Brace.
- Ladefoged, Peter, and Ian Maddieson. 1996. *The Sounds of the World's Languages*. Oxford: Blackwell.
- Laman, Karl E. 1936. *Dictionnaire Kikongo-Français*. [Republished in 1964.] New Jersey: Gregg Press.
- Lamontagne, Greg, and Keren Rice. 1995. A correspondence account of coalescence. In Jill N. Beckman, Laura Walsh Dickey, & Suzanne Urbanczyk, eds., *University of Massachusetts Occasional Papers: Papers in Optimality Theory* 18, 211-223.
- Laver, John. 1994. *Principles of Phonetics*. Cambridge: Cambridge University Press.

- Leben, William R. 1973. *Suprasegmental Phonology*. Doctoral dissertation, MIT. [Published by Garland, New York, 1980.]
- Levergood, Barbara. 1984. Rule governed vowel harmony and the strict cycle. *Proceedings of NELS 14*, pp. 275-293. GLSA.
- Levin, Juliette. 1985. *A Metrical Theory of Syllabicity*. Doctoral dissertation, MIT.
- Lindblom, Björn. 1986. Phonetic universals in vowel systems. In John J. Ohala and Jeri Jaeger, eds., *Experimental Phonology*, pp. 13-44. New York: Academic Press.
- Lindblom, Björn. 1990. On the notion 'possible speech sound'. *Journal of Phonetics* 18, 135-152.
- Lisker, Leigh, and Arthur S. Abramson. 1964. A cross language study of voicing in initial stops: Acoustical measurements. *Word* 20: 384-422.
- Lombardi, Linda. 1990. The non-linear organization of the affricate. *Natural Language and Linguistic Theory* 8.3, 375-425.
- Lombardi, Linda. 1991. *Laryngeal Features and Laryngeal Neutralization*. Doctoral dissertation, University of Massachusetts, Amherst. [Published by Garland Press, 1994.]
- Lombardi, Linda. 1995a. Why place and voice are different: Constraint interactions and featural faithfulness in Optimality Theory. Ms., University of Maryland, College Park.
- Lombardi, Linda. 1995b. Positional faithfulness and the phonology of voicing in Optimality Theory. Ms., University of Maryland, College Park.
- Lombardi, Linda. 1995c. Laryngeal features and privativity. *The Linguistic Review* 12, 35-59.
- Lombardi, Linda. 1998. Evidence for MaxFeature constraints from Japanese. Ms., University of Maryland, College Park.
- Loos, Eugene Emil. 1969. *The Phonology of Capanahua and its Grammatical Basis*. (Doctoral dissertation, University of Texas, Austin, 1967.) University of Oklahoma: Summer Institute of Linguistics Publication, 20.
- Lorentz, Ove. 1995. Tonal prominence and alignment. In Rachel Walker, Ove Lorentz, and Haruo Kubozono, eds., *Phonology at Santa Cruz* 4, 39-56.
- Lunt, Horace. 1973. Remarks on nasality: The case of Guaraní. In Stephen R. Anderson and Paul Kiparsky, eds., *A Festschrift for Morris Halle*, pp. 131-139. New York: Holt, Reinhart and Winston.
- Maddieson, Ian. 1984. *Patterns of Sounds*. Cambridge: Cambridge University Press.

- Mafeni, Bernard. 1969. Isoko. In Elizabeth Dunstan, ed., *Twelve Nigerian Languages*, pp. 115-124. New York: Africana Publishing Corp.
- Malone, Joseph L. 1993. *Tiberian Hebrew Phonology*. Winona Lake: Eisenbrauns.
- Malone, Terrell, et al. 1985. Un bosquejo fonológico y gramatical del Siriano. Ms., Lomalinda: Columbia. [As cited by Bivin 1986.]
- Marantz, Alec. 1982. Re reduplication. *Linguistic Inquiry* 13: 435-482.
- Marlett, Stephen A. 1992. Nasalization in Mixtec dialects. *International Journal of American Linguistics* 58.4, 425-435.
- Matisoff, James A. 1975. Rhinoglottophilia: The mysterious connection between nasality and glottality. In Ferguson, Hyman, and Ohala, eds., pp. 265-287.
- McCarthy, John. 1979. *Formal Problems in Semitic Phonology and Morphology*. Doctoral dissertation, MIT. [Distributed by the Indiana University Linguistics Club, Bloomington, Ind.]
- McCarthy, John. 1981. A prosodic theory of nonconcatenative morphology. *Linguistic Inquiry* 12.3, 373-418.
- McCarthy, John. 1986. OCP effects: Gemination and antigemination. *Linguistic Inquiry* 17, 207-264.
- McCarthy, John. 1994. On coronal 'transparency'. Paper presented at the Trilateral Phonology Weekend 2, University of California, Santa Cruz.
- McCarthy, John. 1995. Extensions of faithfulness: Rotuman revisited. Ms., University of Massachusetts, Amherst.
- McCarthy, John. 1997. Sympathy and phonological opacity. Paper presented at the Hopkins Optimality Theory Workshop/University of Maryland Mayfest 1997, Johns Hopkins University.
- McCarthy, John, and Alan Prince. 1986. *Prosodic Morphology*. Ms., University of Massachusetts, Amherst and Brandeis University.
- McCarthy, John, and Alan Prince. 1990. Foot and word in prosodic morphology: The Arabic broken plural. *Natural Language and Linguistic Theory* 8, 209-282.
- McCarthy, John, and Alan Prince. 1993a. *Prosodic Morphology I: Constraint Interaction and Satisfaction*. Ms., University of Massachusetts, Amherst, and Rutgers University. [To appear Cambridge, Mass.: MIT Press.]
- McCarthy, John, and Alan Prince. 1993b. Generalized alignment. In Geert Booij and Jaap van Marle, eds., *Yearbook of Morphology*, 79-153. Dordrecht: Kluwer.

- McCarthy, John, and Alan Prince. 1994a. An overview of Prosodic Morphology: Parts I and II. [Talks presented at the OTS/HIL Workshop on Prosodic Morphology, Utrecht.]
- McCarthy, John, and Alan Prince. 1994b. Emergence of the unmarked: Optimality in Prosodic Morphology. In Mercè Gonzàles, ed., *Proceedings of NELS 24*, pp. 333-379. GLSA.
- McCarthy, John, and Alan Prince. 1995. Faithfulness and reduplicative identity. In Jill N. Beckman, Laura Walsh Dickey, & Suzanne Urbanczyk, eds., *University of Massachusetts Occasional Papers: Papers in Optimality Theory* 18, 249-384.
- McGinn, Richard. 1979. *Outline of Rejang Syntax*. Doctoral dissertation, University of Hawaii.
- Merchant, Jason. 1997. Sympathetic devoicing and continuancy in Catalan. In Rachel Walker, Motoko Katayama, and Daniel Karvonen, eds., *Phonology at Santa Cruz* 5, 57-62.
- Mester, Armin. 1986. *Studies in Tier Structure*. Doctoral dissertation, University of Massachusetts, Amherst.
- Mester, Armin, and Junko Itô. 1989. Feature predictability and underspecification: Palatal prosody in Japanese mimetics. *Language* 65, 258-293.
- Mester, Armin, and Jaye Padgett. 1994. Directional syllabification in generalized alignment. In Jason Merchant, Jaye Padgett, and Rachel Walker, eds., *Phonology at Santa Cruz* 3, 79-85.
- Migliazza, Ernest, and Joseph E. Grimes. 1961. Shiriana phonology. *Anthropological Linguistics* 3.6, 31-41.
- Miller, Marion. 1976. Fonologia del Desano. *Sistemas fonologicos de idiomas colombianos: Tomo II*, 105-111. Lomalinda, Columbia: Ministerio de Gobierno and Instituto Linguistico de Verano.
- Mohanan, K. P. 1995. The organization of the grammar. In John Goldsmith, ed., *The Handbook of Phonological Theory*, pp. 24-69. Cambridge, Mass.: Blackwell.
- Moore, Deanna. 1996. Reduplication and optimization of prosodic structure. Ms., University of Massachusetts, Amherst.
- Morris, Judith Kay. 1977. *Nasality in Epera*. MA thesis, University of Texas, Arlington.
- Nespor, Marina, and Irene Vogel. 1986. *Prosodic Phonology*. Dordrecht: Foris.
- Ní Chiosáin, Máire, and Jaye Padgett. 1993. Inherent Vplace. Report no. LRC-93-09. Linguistics Research Center, University of California, Santa Cruz.

- Ní Chiosáin, Máire, and Jaye Padgett. 1997. Markedness, segment realization, and locality in spreading. Report no. LRC-97-01, Linguistics Research Center, University of California, Santa Cruz.
- Nivens, Richard. 1992. A lexical phonology of West Tarangan. In Donald A. Burquest and Wyn D. Laidig, eds., *Phonological Studies in Four Languages of Maluku*, pp. 127-227. Summer Institute of Linguistics, University of Texas at Arlington and Pattimura University.
- Nivens, Richard. 1993. Reduplication in four dialects of West Tarangan. *Oceanic Linguistics* 32.2, 353-388.
- North, Joanne, and Jäna Shields. 1977. Silacayoapan Mixtec Phonology. In William R. Merrifield, ed., *Studies in Otomanguean Phonology*. Summer Institute of Linguistics Publications in Linguistics, Publication No. 54, University of Texas at Arlington.
- Noske, Manuela. 1995. *The Ternary use of Distinctive Features: In Defense of the Number Three*. Doctoral dissertation, University of Chicago.
- Odden, David. 1994. Adjacency parameters in phonology. *Language* 70, 289-330.
- Ohala, John. 1971. Monitoring soft palate movements in speech. Paper presented at the 81st meeting of the Acoustical Society of America.
- Ohala, John. 1975. Phonetic explanations for nasal sound patterns. In Ferguson, Hyman, and Ohala, eds., pp. 289-316.
- Ohala, John. 1983. The origin of sound patterns in vocal tract constraints. In P. F. Macneilage, ed., *The Production of Speech*, pp. 189-216. New York: Springer-Verlag.
- Ohala, John. 1990. There is no interface between phonetics and phonology: A personal view. *Journal of Phonetics* 18, 153-171.
- Ohala, John, and Manjari Ohala. 1991. Reply to comentators. *Phonetica* 48, 271-274.
- Ohala, John, and Manjari Ohala. 1993. The phonetics of nasal phonology: Theorems and data. In Huffman and Krakow, eds., pp. 225-249.
- Ohala, John, Maria-Josep Solé, and Goangshiuang Ying. 1998. The controversy of nasalized fricatives. Paper presented at the ICA-ASA Joint Meeting, Seattle, Washington.
- Ohala, Manjari. 1975. Nasals and nasalization in Hindi. In Ferguson, Hyman, and Ohala, eds., pp. 317-332.
- Öhman, S. 1966. Coarticulation in VCV utterances: Spectrographic measurements. *Journal of the Acoustical Society of America* 39, 151-168.

- Öhman, S. 1967. A numerical model of coarticulation. *Journal of the Acoustical Society of America* 41, 310-320.
- Okell, John. 1969. *A Reference Grammar of Colloquial Burmese*. London: Oxford University Press.
- Onn, Farid M. 1980. *Aspects of Malay Phonology and Morphology*. Doctoral dissertation. Universiti Kebangsaan Malaysia, Bangi.
- Opubor, Alfred E. 1969. Itsekeri. In Elizabeth Dunstan, ed., *Twelve Nigerian Languages*, pp. 125-132. New York: Africana Publishing Corp.
- Osborn, Henry A. Jr. 1966. Warao I: phonology and morphophonemics. *International Journal of American Linguistics* 32.2, 108-123.
- Osumi, Midori. 1995. *Tinrin Grammar*. Oceanic Linguistics Special Publication No. 25. Honolulu: University of Hawaii Press.
- Osuna, Tomás. 1952. Noiciones de gramática guaraní. In Anselmo Jover Peralta and Tomás Osuna, *Diccionario guaraní-español y español-guaraní*, pp. 429-488. Buenos Aires.
- Padgett, Jaye. 1994. Stricture and nasal place assimilation. *Natural Language and Linguistic Theory* 12, 465-513.
- Padgett, Jaye. 1995a. Feature classes. In Jill N. Beckman, Laura Walsh Dickey, & Suzanne Urbanczyk, eds., *University of Massachusetts Occasional Papers: Papers in Optimality Theory* 18, 385-420.
- Padgett, Jaye. 1995b. Partial class behavior and nasal place assimilation. In Keiichiro Suzuki and Dirk Elzinga, eds., *Arizona Phonology Conference: Proceedings of the South Western Optimality Theory Workshop, Volume 5, Coyote Papers*, pp. 145-183. University of Arizona, Tucson.
- Padgett, Jaye. 1995c. *Stricture in Feature Geometry*. CSLI Publications, Stanford University. [Revised version of doctoral dissertation, University of Massachusetts, Amherst, 1991.]
- Padgett, Jaye. 1997. Perceptual distance of contrast: Vowel height and nasality. In Rachel Walker, Motoko Katayama, and Daniel Karvonen., eds., *Phonology at Santa Cruz* 5, 63-78.
- Pandharipande, Rajeshwari V. 1997. *Marathi*. New York: Routledge.
- Pankratz, Leo, and Eunice V. Pike. 1967. Phonology and morphotonemics of Ayutla Mixtec. *International Journal of American Linguistics* 33, 287-299.
- Pater, Joe. 1995. On the nonuniformity of weight-to-stress and stress preservation effects in English. Ms., McGill University.

- Pater, Joe. 1996. *NC. In Kiyomi Kusumoto, ed., *Proceedings of NELS 26*, pp. 227-239. GLSA.
- Pater, Joe. In press. Austronesian Nasal Substitution and other NC effects. In René Kager, Harry van der Hulst, and Wim Zonneveld, eds., *Proceedings of OTS/HIL Workshop on Prosodic Morphology*.
- Patnaik, Sudatta. 1984. Some syllable-based phenomena in Oriya: a non-linear approach. *McGill Working Papers in Linguistics* 2.1, 31-64.
- Payne, David L. 1974. *Nasality in Aguaruna*. MA thesis. University of Texas at Arlington.
- Pease, Helen & Lavera Betts. 1971. Parintintin phonology. In David Bendor-Samuel, ed. *Tupi Studies I*, 1-14. Summer Institute of Linguistics Publications in Linguistics and Related Fields, Publication No. 29. University of Oklahoma, Norman.
- Pétursson, M. 1973. Phonologie des consonnes nasales en islandais modernes. *La Linguistique* 9, 115-138.
- Pickett, J. M. 1980. *The Sounds of Speech Communication: A Primer of Acoustic Phonetics and Speech Perception*. Baltimore, Md.: University Park Press.
- Pierrehumbert, Janet. 1980. *The Phonology and Phonetics of English Intonation*. Doctoral dissertation, MIT.
- Pierrehumbert, Janet. 1993a. Dissimilarity in the Arabic verbal roots. In Amy Schafer, ed., *Proceedings of NELS 23*, pp. 367-381. GLSA.
- Pierrehumbert, Janet. 1993b. Alignment and prosodic heads. In *Proceedings of ESCOL 1993*.
- Piggott, Glyne. 1987. On the autonomy of the feature Nasal. In Anna Bosch, Barbara Need, and Eric Schiller, eds. *CLS 23, Papers from the Parasession on Autosegmental and Metrical Phonology*, pp. 223-238.
- Piggott, Glyne. 1992. Variability in feature dependency: The case of nasality. *Natural Language and Linguistic Theory* 10, 33-78.
- Piggott, Glyne. 1996. Implications of consonant nasalization for a theory of harmony. *Canadian Journal of Linguistics* 41.2, 141-174.
- Pike, Eunice V., and Thomas Ibach. 1978. The phonology of the Mixtepec dialect of Mixtec. In Mohammad Ali Jazayery, Edgar C. Polomé, and Werner Winter, eds., *Linguistic and Literary Studies in Honor of Archibald Hill, Descriptive Linguistics II*, pp. 271-285.
- Pike, Eunice V., and Priscilla Small. 1974. Downstepping terrace tone in Coatzospan Mixtec. In Ruth M. Brend, ed., *Advances in Tagmemics*, pp. 105-134. Amsterdam: North Holland.

- Poser, William J. 1982. Phonological representation and action-at-a-distance. In Harry van der Hulst and Norval Smith, eds., *The Structure of Phonological Representations* (part II), pp. 121-158. Dordrecht: Foris.
- Prince, Alan. 1975. *The Phonology and Morphology of Tiberian Hebrew*. Doctoral dissertation, MIT.
- Prince, Alan. 1996. Aspects of mapping under OT. Paper presented at the University of Santa Cruz.
- Prince, Alan. 1997. Endogenous constraints on Optimality Theory. Paper presented at the Hopkins Optimality Theory Workshop/Maryland Mayfest 1997, Johns Hopkins University.
- Prince, Alan, and Paul Smolensky. 1993. Optimality Theory: Constraint interaction in generative grammar. Ms., Rutgers University, and University of Colorado, Boulder. RuCCS-TR-2. [To appear, Cambridge, Mass.: MIT Press.]
- Pulleyblank, Douglas. 1989. Patterns of feature cooccurrence: The case of nasality. In S. Lee Fulmer, Masahide Ishihara, & Wendy Wiswall, eds., *Proceedings of the Arizona Phonology Conference*. *Coyote Papers* 9, 98-115.
- Pulleyblank, Douglas. 1993. Vowel harmony and Optimality Theory. *Proceedings of the Workshop on Phonology*, pp. 1-18. Associação Portuguesa de Linguística, University of Coimbra, Portugal.
- Pulleyblank, Douglas. 1996. Neutral vowels in Optimality Theory: A comparison of Yoruba and Wolof. *Canadian Journal of Linguistics* 41.4, 295-347.
- Pullum, Geoffrey K. 1976. The Duke of York gambit. *Journal of Linguistics* 12, 83-102.
- Rice, Keren. 1993. A reexamination of the feature [Sonorant]: The status of 'sonorant obstruents,' *Language* 69.2, 308-344.
- Rich, F. 1963. Arabela phonemes and high level phonology. *Studies in Peruvian Indian Languages*. Summer Institute of Linguistics, no. 9, pp. 193-206.
- Ringen, Catherine O. 1975. *Vowel Harmony: Theoretical Implications*. Doctoral dissertation, Indiana University.
- Ringen, Catherine O., and Robert M. Vago. 1997. Hungarian vowel harmony in Optimality Theory. Ms., University of Iowa and Queens College and The Graduate Center, CUNY.
- Rivas, Alberto M. 1974. Nasalization in Guaraní. Ms., MIT.
- Rivas, Alberto M. 1975. Nasalization in Guaraní. *Proceedings of NELS 5*, ed. by Ellen Kaisse and Jorge Hankamer, 134-143. Harvard University Linguistics Department.

- Robins, R. H. 1953. The phonology of the nasalized verbal forms in Sundanese. *Bulletin of the School of Oriental and African Studies* 15, 138-145.
- Robins, R. H. 1957. Vowel nasality in Sundanese. *Studies in Linguistic Analysis*, pp. 87-103. London: Basil Blackwell.
- Rose, Sharon. 1997. *Theoretical Issues in Comparative Ethio-Semitic Phonology and Morphology*. Doctoral dissertation, McGill University.
- Rosenthal, Sam. 1997. The distribution of prevocalic vowels. *Natural Language and Linguistic Theory* 15.1, 139-180.
- Rountree, S. Catherine. 1972. The phonological structure of stems in Saramaccan. In Joseph E. Grimes, ed., *Languages of the Guianas*, pp. 22-27. University of Oklahoma: Summer Institute of Linguistics Publication, 35.
- Ruhlen, Merritt. 1975. Patterning of nasal vowels. In Ferguson, Hyman, and Ohala, eds., pp. 333-352.
- Safir, Ken. 1982. Nasal spreading in Capanahua. *Linguistic Inquiry* 13, 689-694.
- Sagey, Elizabeth. 1986. *The Representation of Features and Relations in Nonlinear Phonology*. Doctoral dissertation, MIT. [Published by Garland, New York, 1990.]
- Sagey, Elizabeth. 1988. On the ill-formedness of crossing association lines. *Linguistic Inquiry* 19, 109-118.
- Salser, J. K. Jr. 1971. Cubeo Phonemics. *Linguistics* 75, 74-79. Mouton: The Hague.
- Samarin, William J. 1966. *The Gbeya Language*. University of California Publication in Linguistics 50. Berkeley: University of California Press.
- Samek-Lodovici, Vieri. 1992. A unified analysis of crosslinguistic morphological gemination. *Proceedings of CONSOLE 1*. Utrecht.
- Samek-Lodovici, Vieri. 1993. Morphological gemination crosslinguistically. Ms., Rutgers University, of paper presented at the Rutgers Optimality Workshop I.
- Sanders, Nathan. 1997. On sympathetic correspondence. In Rachel Walker, Motoko Katayama, and Daniel Karvonen, eds., *Phonology at Santa Cruz* 5, 91-102.
- Schadeberg, Thilo C. 1982. Nasalization in UMBundu. *Journal of African Languages and Linguistics* 4, 109-132.
- Schourup, Lawrence. 1972. Characteristics of vowel nasalization. *Papers in Linguistics* 5, 530-548.
- Schourup, Lawrence. 1973. A cross-language study of vowel nasalization. In Angeliki Malikouti-Drachman, Gaberell Drachman, Mary Louise Edwards, Jonnie E. Geis,

- and Lawrence C. Schourup.. eds., *Ohio State Working Papers in Linguistics* 15. 190-221.
- Scobbie, James. 1991. *Attribute Value Phonology*. Doctoral dissertation, University of Edinburgh.
- Scott, Norman C. 1957. Notes on the pronunciation of Sea Dayak. *Bulletin of the School of Oriental and African Studies* 20, 509-512.
- Scott, Norman C. 1964. Nasal consonants in Land Dayak (Bukar Sadong). In D. Abercrombie, D. B. Fry, P. A. D. MacCarthy, N. C. Scott, and J. L. M. Trim, eds. *In Honour of Daniel Jones*, pp. 432-436. London: Longmans.
- Selkirk, Elisabeth O. 1984. On the major class features and syllable theory. In M. Aronoff and R. T. Oehrle, eds., *Language Sound Structure*, pp. 107-136. Cambridge, Mass.: MIT Press.
- Selkirk, Elisabeth O. 1986. On derived domains in sentence phonology. *Phonology* 3, 371-405.
- Selkirk, Elisabeth O. 1994. Optimality Theory and featural phenomena. Lecture notes, LING 730, University of Massachusetts, Amherst.
- Selkirk, Elisabeth O. 1995. Surface restrictions in the distribution of lexical contrasts: The role for root faithfulness. Handout of a talk presented in LING 751, University of Massachusetts, Amherst.
- Sievers, E. 1881. *Grundzüge der Phonetik*. Leipzig: Breitkopf and Hartel.
- Smith, Jennifer L. 1997. Noun faithfulness: Evidence from accent in Japanese dialects. Paper presented at Japanese/Korean Linguistics 7.
- Smith, Richard, and Connie Smith. 1971. Southern Barasano phonemics. *Linguistics* 75, 80-85.
- Smolensky, Paul. 1993. Optimality, markedness, and phonological activity. Paper presented at the Rutgers Optimality Workshop I.
- Smolensky, Paul. 1995. On the internal structure of the constraint component *Con* of UG. Handout of talk, March 1995. Johns Hopkins University.
- Smolensky, Paul. 1997. Constraint interaction in generative grammar II: Local conjunction (or, random rules in Universal Grammar). Paper presented at the Hopkins Optimality Theory Workshop/Maryland Mayfest 1997, Johns Hopkins University.
- Spaelti, Philip. 1997. *Dimensions of Variation in Multi-Pattern Reduplication*. Doctoral dissertation, University of California, Santa Cruz.
- Sportiche, D. 1977. Un fragment de phonologie du guaraní. Ms., MIT.

- Stampe, David. 1979. *A Dissertation on Natural Phonology*. Bloomington, Ind.: Indiana University Linguistics Club. [Corrected version of doctoral dissertation, University of Chicago, 1973.]
- Steriade, Donca. 1982. *Greek Prosodies and the Nature of Syllabification*. Doctoral dissertation, MIT.
- Steriade, Donca. 1993a. Closure, release, and nasal contours. In Huffman and Krakow, eds., pp. 401-470.
- Steriade, Donca. 1993b. Segments, contours and clusters. In A. Crochetière, J.-C. Boulanger and C. Ouellen, eds., *Actes du 15ème Congrès International des Linguistes*. Presses Universitaires Laval, Ste. Foy, Quebec, pp. 71-82.
- Steriade, Donca. 1993c. Positional neutralization. Paper presented at *NELS 24*.
- Steriade, Donca. 1993d. Orality and markedness. In B. Keyser and J. Guenther, eds., *Berkeley Linguistics Society 19*, 334-347. University of California, Berkeley.
- Steriade, Donca. 1994. Complex onsets as single segments: The Mazateco pattern. In Jennifer Cole and Charles Kisseberth, eds., *Perspectives in Phonology* CSLI Lecture Notes, No. 51, pp. 203-291. CSLI: Stanford University.
- Steriade, Donca. 1995a. Underspecification and markedness. In John Goldsmith, ed., *Handbook of Phonology*, pp. 114-174. London: Basil Blackwell.
- Steriade, Donca. 1995b. Positional Neutralization. Ms., UCLA.
- Steriade, Donca. 1997. Phonetics in phonology: The case of laryngeal neutralization. Ms., UCLA.
- Stevens, Alan M. 1968. *Madurese Phonology and Morphology*. American Oriental Series No. 52. New Haven, Conn.: American Oriental Society.
- Stevens, Alan M. 1985. Reduplication in Madurese. In *Proceedings of the Second Eastern States Conference on Linguistics*, pp. 232-242. Linguistics Department, Ohio State University. [Also appears in *CUNY Forum* 11, 92-102.]
- Stevens, K. N. 1968. Acoustic correlates of place of articulation for stop and fricative consonants. *Quarterly Progress Report* 89, 199-205. Cambridge, Mass.: MIT.
- Stolte, Joel, and Nancy Stolte. 1971. A description of Northern Barasano phonology. *Linguistics* 75, 86-92. The Hague: Mouton.
- Stringer, M., and J. Hotz. 1973. Waffa phonemes. In H. McKaughan, ed., *The Languages of the Eastern family of the East New Guinea Highland Stock*, pp. 523-529. Seattle: University of Washington Press.
- Takeda, Kazue. 1997. Causative formation and single consonant reduplication in Kammu. Ms., University of California, Irvine.

- Taylor, Douglas. 1951. Morphophonemics of Island Carib (Central American Dialect). *International Journal of American Linguistics* 17.4.
- Ternes, Elmar. 1970. *Grammaire structurale du breton de l'Île de Groix*. Heidelberg: Carl Winter Universitätsverlag.
- Ternes, Elmar. 1973. *The Phonemic Analysis of Scottish Gaelic*. (Forum Phonetikum 1.) Hamburg: Helmut Buske Verlag.
- Thomas, J. M. C. 1963. *Le Parler Ngbaka de Bokuna: Phonologie, Morphologie, Syntax*. Paris: Mouton.
- Trail, Robert L. 1970. *The Grammar of Lamani*. Summer Institute of Linguistics Publication No. 24. University of Oklahoma. [Reproduction of doctoral dissertation, 1968. University of Poona.]
- Tranel, Bernard. 1997. Remarks on suppletive allomorphy and OT. Paper presented at the University of California, Santa Cruz.
- Trigo, R. Lorenza. 1988. *On the Phonological Derivation and Behavior of Nasal Glides*. Doctoral dissertation, MIT.
- Trigo, R. Lorenza. 1993. The inherent structure of nasal segments. In Huffman and Krakow, eds., pp. 369-400.
- Urbanczyk, Suzanne. 1995. Double reduplications in parallel. In Jill Beckman, Laura Walsh Dickey, and Suzanne Urbanczyk, eds., *University of Massachusetts Occasional Papers in Linguistics 18: Papers in Optimality Theory*, 499-531.
- Urbanczyk, Suzanne. 1996a. Morphological templates in reduplication. In Kiyomi Kusumoto, ed., *Proceedings of NELS 26*, pp. 425-440. GLSA.
- Urbanczyk, Suzanne. 1996b. *Patterns of Reduplication in Lushootseed*. Doctoral dissertation, University of Massachusetts, Amherst.
- Vago, Robert M. 1973. Abstract vowel harmony systems in Uralic and Altaic languages. *Language* 49.3, 579-605.
- Vago, Robert M. 1976. Theoretical implications of Hungarian vowel harmony. *Linguistic Inquiry* 7, 242-263.
- Velie, Daniel, and Virginia Velie. 1981. *Vocabulario Orejon*. Serie Lingüística Peruana, No. 16. Yarinacocha, Peru: Instituto Lingüístico de Verano.
- Vergnaud, Jean-Roger, and Morris Halle. 1978. Metrical structures in phonology. Ms., (fragment of a draft). MIT.
- Walker, Rachel. 1995. Hierarchical opacity effects in nasal harmony. In Janet Fuller, Ho Han, and David Parkinson, eds., *Proceedings of the Eleventh Eastern States Conference on Linguistics*, pp. 318-329. Ithaca, NY: DMLL Publications.

- Walker, Rachel. 1996. Transparent obstruents undergo nasal harmony. Paper presented at the North West Linguistics Conference, University of Washington.
- Walker, Rachel. 1997a. Round harmony and featural tautosyllabicity. In Leslie Blair, Christine Burns, and Lorna Rowsell, eds., *Proceedings of the 1997 Annual Conference of the Canadian Linguistic Association*, pp. 251-262. Calgary Working Papers in Linguistics.
- Walker, Rachel. 1997b. Faith and markedness in Esimbi feature transfer. In Rachel Walker, Motoko Katayama, and Daniel Karvonen., eds., *Phonology at Santa Cruz* 5, 103-115.
- Walker, Rachel. 1997c. Phonological cooccurrence restrictions and locality. Ms., University of California, Santa Cruz.
- Walker, Rachel. 1998. A minimal triplet in Altaic: Round harmony, licensing, and bisyllabic triggers. Ms., University of California, Santa Cruz.
- Walker, Rachel, and Geoffrey K. Pullum. 1997. Possible and impossible segments. Ms., University of California, Santa Cruz.
- Waltz, Nathan, and Carolyn Waltz. 1967. Guanano phonemics. In Benjamin Elson, ed., *Phonemic Systems of Colombian Languages*, pp. 25-36. Norman, Oklahoma: SIL.
- Waltz, Nathan, and Carolyn Waltz. 1972. Fonología del Guanano. *Sistemas fonológicos de idiomas colombianos*, pp. 29-40. Lomalinda, Columbia: Instituto Linguístico del Verano.
- Ward, Ida C. 1952. *An introduction to the Yoruba Language*. Cambridge: W. Heffer and Sons Ltd.
- Welmers, William E. 1952. Notes on the structure of Bariba. *Language* 28.1, 82-103.
- Welmers, William E. 1962. The phonology of Kpelle. *Journal of African Languages* 1, 69-93.
- West, Birdie. 1980. *Gramatica popular del Tucano*. Trans. by Ann Pilat de Galvis. Bogotá, Colombia: Instituto Linguístico de Verano.
- West, Birdie, and Betty Welch. 1967. Phonemic system of Tucano. In Benjamin Elson, ed., *Phonemic Systems of Columbian Languages*, pp. 11-24. Norman, Oklahoma: SIL.
- West, Birdie, and Betty Welch. 1972. Sistema fonológico del Tucano. *Sistemas fonológicos de idiomas colombianos*, vol. 1, pp. 13-28. Lomalinda, Columbia: Instituto lingüístico de Verano.
- Westbury, John. 1983. Enlargement of the supraglottal cavity and its relation to stop consonant voicing. *Journal of the Acoustical Society of America* 74, 1322-36.

- Westbury, John, and Patricia Keating. 1986. On the naturalness of stop consonant voicing. *Journal of Linguistics* 22, 145-166.
- Westley, David O. 1971. The Tepetotutla Chinantec stressed syllable. *International Journal of American Linguistics* 37, 160-163.
- Whalen, D. H., and Patrice S. Beddor. 1989. Connections between nasality and vowel duration and height: Elucidation of the Eastern Algonquian intrusive nasal. *Language* 65.3, 457-486.
- Wiese, Richard. 1996. *The Phonology of German*. Oxford: Clarendon Press.
- Williamson, Kay. 1965. *A Grammar of the Kolokuma Dialect of Ijo*. Cambridge: Cambridge University Press.
- Williamson, Kay. 1969a. Igbo. In Elizabeth Dunstan, ed., *Twelve Nigerian Languages*, pp. 85-96. New York: Africana Publishing Corp.
- Williamson, Kay. 1969b. Ijo. In Elizabeth Dunstan, ed., *Twelve Nigerian Languages*, pp. 97-114. New York: Africana Publishing Corp.
- Williamson, Kay. 1987. Nasality in Ijo. In David Odden, ed., *Current Approaches to African Linguistics*, Vol. 4, pp. 397-415. Dordrecht: Foris.
- Wilson, Colin. 1997. Absolute harmony, relativized minimality, and blocking. Paper presented at the Hopkins Optimality Theory Workshop/University of Maryland Mayfest 1997, Johns Hopkins University.
- Wonderly, William. 1951. Zoque I, II, III, IV. *International Journal of American Linguistics* 17, 1-9, 105-123, 137-162, 235-221.
- Wright, James T. 1986. The behavior of nasalized vowels in the perceptual vowel space. In John J. Ohala and Jeri J. Jaeger, eds., *Experimental Phonology*, pp. 45-67. New York: Academic Press.
- Yip, Moira. To appear. Feet, tonal reduction and speech rate at word and phrase level in Chinese. In Rene Kager and Wim Zonnefeld, eds., *Phrasal Phonology*. Dordrecht: Foris Publications.
- Zec, Draga. 1988. *Sonority Constraints on Syllable Structure*. Doctoral dissertation. Stanford University.
- Zec, Draga, and Sharon Inkelas. 1990. Prosodically constrained syntax. In Sharon Inkelas and Draga Zec, eds., *The Phonology-Syntax Connection*, pp. 365-378. Chicago: University of Chicago Press.
- Zoll, Cheryl. 1996. *Parsing below the Segment in a Constraint Based Framework*. Doctoral dissertation, University of California, Berkeley.
- Zoll, Cheryl. 1997. Licensing: Positional markedness or positional faithfulness. Handout of paper presented at Yale University.

Zoll, Cheryl. In press. Conflicting directionality. *Phonology*.